

This substantive policy statement is advisory only. A substantive policy statement does not include internal procedural documents that only affect the internal procedures of the agency and does not impose additional requirements or penalties on regulated parties or include confidential information or rules made in accordance with the Arizona administrative procedure act. If you believe that this substantive policy statement does impose additional requirements or penalties on regulated parties you may petition the agency under section 41-1033, Arizona Revised Statutes, for a review of the statement.

SITE INVESTIGATION GUIDANCE MANUAL



Janice K. Brewer, Governor
Henry R. Darwin, Director

ARIZONA DEPARTMENT OF ENVIRONMENTAL QUALITY **Waste Programs Division**

Date: October 2014

ACRONYMS

AAC	Arizona Administrative Code
AAR	Arizona Administrative Register
ADWR	Arizona Department of Water Resources
AFCEE	Air Force Center for Engineering and the Environment
API	American Petroleum Institute
ARS	Arizona Revised Statutes
ASTM	American Society for Testing and Materials
ATSDR	Agency of Toxic Substances and Disease Research
AWQS	Aquifer Water Quality Standards
BLRA	Baseline Risk Assessment
BTEX	Benzene, toluene, ethylbenzene and xylenes
CDC	Center for Disease Control
CERCLA	Comprehensive Environmental Response, Compensation and Liability Act
CFR	Code of Federal Regulations
COC	Contaminant or Chemical of Concern
CPT	Cone Penetrometer Test
CSM	Conceptual Site Model
DCE	Dichloroethene
DNAPL	Dense Non-Aqueous Phase Liquid
DoD	Department of Defense
DO	Dissolved Oxygen
DOI	Depth of Incorporation
DQO	Data Quality Objective
DU	Decision Unit
EPA	United States Environmental Protection Agency
GC	Gas Chromatography
GC/MS	Gas Chromatography/Mass Spectrometry
GPL	Groundwater Protection Level
HVAC	Heating, Ventilation and Air Conditioning
ITRC	Interstate Technical Regulatory Council
LNAPL	Light Non-Aqueous Phase Liquid
LUST	Leaking Underground Storage Tank
MCLs	Maximum Contaminant Levels
MNA	Monitored Natural Attenuation
MSWLF	Municipal Solid Waste Landfill
NAPL	Non-Aqueous Phase Liquid
NJDEP	New Jersey Department of Environmental Protection
NOM	National Organic Matter
NPDWS	National Primary Drinking Water Standards
NPL	National Priorities List
NSDWS	National Secondary Drinking Water Standards
PWS	Public Water System
ORP	Oxidation Reduction Potential
PCE	Tetrachloroethene

October 2014 ADEQ Waste Programs Division
Site Investigation Guidance Manual

PDBs	Passive Diffusion Bags
PRT	Post Run Tubing
QA/QC	Quality Assurance/Quality Control
RCRA	Resource Conservation and Recovery Act
RCS	Rational Choice Strategy
RPD	Recognition Primed Decision model
RSLs	Regional Screening Levels (EPA)
rSRLs	Residential Soil Remediation Level
SARA	Superfund Amendments Reauthorization Act
SMCL	Secondary Maximum Contaminant Levels
SRL	Soil Remediation Level
SVE	Soil Vapor Extraction
SVOCs	Semi-volatile Organic Compounds
TCE	Trichloroethene
TDS	Total Dissolved Solids
TEA	Terminal Electron Acceptor
TIC	Tentatively Identified Compound
USACE	United States Army Corps of Engineers
UST	Underground Storage Tank
VOCs	Volatile Organic Compounds
VC	Vinyl chloride
VRP	Voluntary Remediation Program
WPD	Waste Programs Division
WQARF	Water Quality Assurance Revolving Fund
WQDB	Water Quality Database
WRRC	Water Resources Research Council

DISCLAIMER

Any mention of trade names or commercial products is for identification only and does not constitute endorsement or recommendation by the Arizona Department of Environmental Quality.

ACKNOWLEDGEMENTS

Many individuals contributed to the preparation and review of this guidance manual. This document was prepared by senior technical staff of the Waste Programs Division of the Arizona Department of Environmental Quality (ADEQ). The ADEQ wishes to thank all past and present ADEQ staff for their hard work and assistance to the Department in the creation of this guidance manual.

Special thanks to ADEQ's own Chuck Graf for letting us use his training pamphlet on *Behavior of Organic Contaminants in the Subsurface* as part of this guidance manual (see Section 7.1). That pamphlet was prepared during the early 1990's and has been used as a reference by ADEQ technical staff since that time.

Authors: Wayne Pudney, Arizona Department of Environmental Quality
Scott Goodwin, Arizona Department of Environmental Quality
Rich Olm, Arizona Department of Environmental Quality
Craig Kafura, Arizona Department of Environmental Quality (retired)

FOREWORD

In Arizona, hundreds of operating and abandoned industrial and commercial facilities and waste disposal sites exist. Some of these sites may have the potential to adversely affect public health. The mission of the Waste Programs Division of Arizona Department of Environmental Quality (ADEQ) is to protect and enhance public health and the environment by reducing the risk associated with waste management, contaminated sites and regulated substances.

This guidance manual emphasizes the importance of careful planning, coordination of scientific analyses, and communication during and throughout the investigative process. This guidance manual is just one tool available to the environmental contaminant investigative team, and is not intended to supplant the professional judgment or discretion of the professional in compiling and analyzing data, drawing conclusions, and making recommendations. Instead, it is intended to provide the professional with a logical approach to adopt for investigating releases of regulated substances to the environment at sites throughout Arizona. Furthermore, it allows the professional the flexibility to develop new approaches to the site investigation process including application of the most current and appropriate science and methodology.

The contents of this guidance manual are general in nature, reflect the administrative and technical components of the programs as described in rule, and are subject to revision in keeping with the latest developments in technology, professional practices and statutory changes. This guidance manual and its subsequent revisions will be available at the ADEQ website.

This guidance manual was developed to provide the regulated community and ADEQ technical staff with guidance for the development of contaminant investigation strategies. It is to be utilized by ADEQ staff as an aid in determinations regarding adequacy of site investigations. It creates no substantive or procedural rights in any person.

Nothing in this guidance manual supersedes any state or federal regulation. Complete conformity with the information in this document does not guarantee acceptance of all results by ADEQ, nor does it establish that all investigative activities undertaken are reasonable or necessary. Site-specific variances from the details of this document may be warranted, and will require use of professional judgment. This guidance manual addresses generalities encountered at most contaminated sites, and does not constitute an account for all site-specific conditions. As such, some of the guidance provided may not be applicable to a given contaminated site, consequently, some prescribed activities may not be reasonable, necessary or cost-effective depending upon site-specific conditions.

Whether or not the regulated community chooses to follow this guidance manual, any investigative activities must be performed in accordance with all applicable Arizona Administrative Code and pursuant to Arizona Revised Statutes. Investigative activities must:

- assure the protection of public health and welfare and the environment;
- to the extent practicable, provide for the control, management or cleanup of regulated substances so as to allow the maximum beneficial use of the water and soil of this state; and

October 2014 ADEQ Waste Programs Division
Site Investigation Guidance Manual

- be reasonable, necessary, cost-effective and technically feasible.

Some wording of this guidance manual is taken from other sources of information. These sources are provided as references. While citations are noted, the references should be consulted for the exact language attributed to these publications. Some of the citation wording may have been changed during our editing/internal review process. Additional information on investigating, delineating, and remediation of groundwater can be obtained from a variety of publications, including those listed in the attached bibliography.

This guidance manual is not intended to address every nuance of a site investigation. Generally accepted industry standards of practice for all aspects of site investigations are available from guidance and standards published by U.S. Environmental Protection Agency (EPA), Interstate Technology & Regulatory Council (ITRC), American Society of Testing and Materials (ASTM), and the American Petroleum Institute (API). Care should be taken to utilize the most recent versions of the available documents. Some of these documents may be obtained online at the following websites: <http://www.api.org/publications-standards-and-statistics/publications>, <http://www.ntis.gov/>, <http://www.epa.gov/epahome/publications.htm>, and <http://www.itrcweb.org>. Other website addresses are incorporated into this document as appropriate.

ADEQ is committed to updating the guidance manual as new technical information becomes available. The Department welcomes comments from users of this guidance manual. Comments can be submitted to Wayne Pudney at wdp@azdeq.gov.

ADEQ VISION AND MISSION

ADEQ Vision and Mission

Agency Vision: To lead Arizona and the nation in protecting the environment and improving the quality of life for the people of our state.

Agency Mission: To protect and enhance public health and the environment in Arizona.

Waste Programs Division Mission: The mission of the Waste Programs Division is to protect and enhance public health and the environment by reducing the risk associated with waste management, contaminated sites and regulated substances.

PURPOSE OF THIS GUIDANCE MANUAL

The purpose of this guidance manual is to provide a framework for performing site investigations for programs administered by the Arizona Department of Environmental Quality (ADEQ) Waste Programs Division. This framework should be used in concert with all applicable Arizona statutes, rules and published policy and guidance. This guidance manual is intended for all programs and parties conducting site investigation activities including the Voluntary Remediation Program (VRP), Underground Storage Tank (UST) Program, Water Quality Assurance Revolving Fund (WQARF) Program, Comprehensive Environmental Response, Compensation and Liability Act (CERCLA), Resource Conservation and Recovery Act (RCRA), Solid Waste Program; Federal Projects; and the Brownfields Cleanup Program.

This guidance manual **promotes the use of a Conceptual Site Model (CSM)** as the principal site management and decision making tool that is continuously updated as new data becomes available. A CSM is a written and/or illustrative representation of the conditions including the physical, chemical and biological processes that control the transport, migration and potential impacts of contamination (in soil, air, groundwater, surface water and/or sediments) to human and/or ecological receptors. This guidance manual promotes the use of a CSM throughout the life of the investigation process.

ORGANIZATION OF THIS GUIDANCE MANUAL

This manual contains seven sections and is organized as follows:

Section 1: Section 1 has three main goals: 1) to introduce some of Arizona's water issues; 2) to familiarize the reader with Arizona's different geological/groundwater environments; and 3) to describe some of the contaminant issues associated with groundwater in Arizona. Individuals conducting site investigations should be knowledgeable of these issues so that they can ensure proper investigative

October 2014 ADEQ Waste Programs Division
Site Investigation Guidance Manual

techniques are utilized (e.g. drilling and sampling techniques will often vary from one physiographic province to another).

- Section 2: Section 2 gives a brief overview of the ADEQ programs for which this guidance manual is intended.
- Section 3: Section 3 describes the CSM development process and the importance of using it during the decision making and communications processes.
- Section 4: Section 4 describes Exposure Pathways and their importance to site investigations and the development of a CSM.
- Section 5: Section 5 provides information on site investigation project planning approaches.
- Section 6: Section 6 provides information on site investigation sampling considerations for soil, soil vapor, and groundwater.
- Section 7: Section 7 addresses and provides additional information on various topics such as contaminant behavior in the subsurface and groundwater geochemistry. Understanding the topics addressed in this section are integral for completing a full site investigation.

Table of Contents

ACRONYMS	2
DISCLAIMER	4
ACKNOWLEDGEMENTS	5
FOREWORD	6
ADEQ VISION AND MISSION	8
PURPOSE OF THIS GUIDANCE MANUAL	8
ORGANIZATION OF THIS GUIDANCE MANUAL.....	8
List of Appendices	14
List of Figures	15
List of Tables	16
Important Information You Should Know after Reading Section 1.0	17
Section 1.0 Introduction to Arizona Water Issues	18
1.1 Arizona Water Sources.....	18
1.1.1 Local Water Sources	18
1.2 Physiographic Provinces/Aquifers in Arizona	20
1.2.1 Colorado Plateau	21
1.2.2 Transition Zone.....	23
1.2.3 Basin and Range	24
1.3 Contaminants in Water.....	25
1.3.1 Drinking Water Guidelines and Standards	25
1.3.2 Naturally Occurring Well Water Contaminants	28
1.3.3 Examples of Anthropogenic Contaminants	31
Important Information You Should Know after Reading Section 2.0	36
Section 2.0 Program Summaries, Statutes and Administrative Code	37
2.1 Voluntary Remediation Program (VRP).....	37
2.1.1 Statutes, Administrative Code and Submittals.....	38
2.2 Underground Storage Tanks (UST) Program	38
2.2.1 Statutes, Administrative Code and Submittals.....	38
2.3 Water Quality Assurance Revolving Fund, CERCLA and DoD Programs.....	39
2.3.1 Statutes, Administrative Code and Submittals.....	39
2.4 Hazardous Waste Program.....	40
2.4.1 Statutes and Administrative Code.....	41
2.5 Solid Waste Program	41

October 2014 ADEQ Waste Programs Division
Site Investigation Guidance Manual

2.5.1	Statutes and Administrative Code.....	41
2.6	Cleanup Standards and EPA Region 9 Screening Levels	42
2.6.1	Narrative Aquifer Water Quality Standards	43
2.6.2	Regional Screening Levels	44
	Important Information You Should Know after Reading Section 3.0	45
	Section 3.0 The Conceptual Site Model (CSM)	46
3.1	What is a CSM	46
3.1.1	Categories, Elements and Checklists	48
3.1.2	Typical Investigative CSM Related Questions	52
3.1.3	CSM Formats	53
3.2	Development of the Working CSM	54
3.2.1	Description of Working CSM Scope – Site-wide or Area of Concern.....	54
3.2.2	Description of the Working CSM - Extent of Investigative Area	54
3.2.3	CSM Development Beyond the Initial Investigative Stage	55
3.3	A Tool for Decision Making	56
3.4	Identification of Human and Ecological Receptors	56
3.5	Narrative Description	57
3.6	Other reference utilized.....	57
	Important Information You Should Know after Reading Section 4.0	58
	Section 4.0 Exposure Pathways	59
4.1	Complete, Potentially Complete and Incomplete Exposure Pathways	59
4.2	Exposure Pathway Elements	60
4.2.1	Contamination sources (The first element of an exposure pathway).....	62
4.2.2	Environmental Media/Fate and Transport (The second element of an exposure pathway)	63
4.2.3	Exposure Points (The third element of an exposure pathway)	69
4.2.4	Exposure Routes (The fourth element of an exposure pathway).....	69
4.2.5	Receptor/Population (The fifth element of an exposure pathway).....	70
4.3	Receptor Descriptions	70
4.4	Reference websites	71
	Important Information You Should Know After Reading Section 5.0.....	73
	Section 5.0 Planning Investigation of Contamination	75
5.1	Systematic Planning Methods for Environmental Data Collection	76
5.1.1	DQO Process.....	76
5.1.2	Triad Approach	78

October 2014 ADEQ Waste Programs Division
 Site Investigation Guidance Manual

5.1.2.1	Comparison of Non-Dynamic and Dynamic Work Strategies	78
5.1.2.2	Management of Decision Uncertainty within the Triad Approach	82
5.1.2.3	Example of Recognition-primed Decision	83
5.1.3	Comparing the Triad Approach Against the DQO Process	83
5.1.4	Reference Websites.....	84
	Important Information You Should Know after Reading Section 5.2	85
5.2	Sampling Considerations – Decision Units.....	86
5.2.1	Decision Units – Primary Types	87
5.2.1.1	Exposure Area Decision Units	87
5.2.1.2	Source Area Decision Units	89
5.2.2	Background Sampling.....	90
5.2.3	Hot Spots.....	92
5.2.4	Incremental Sampling Method.....	92
5.2.5	Soil Vapor Sampling.....	93
5.2.6	Confidence limits	93
5.2.7	Chemical Analysis of Soil, Groundwater and Soil Vapor (Table)	93
5.2.7.1	Additional Chemical Data Requirements for LUST Releases	94
	Important Information You Should Know after Reading Section 6.1	96
	Section 6.0 Soils, Soil Vapor and Groundwater.....	97
6.1	Soil Sampling	97
6.1.1	Unified Soil Classification System and Other Soil Descriptions	97
6.1.2	Soil Contaminant Fate and Transport	101
6.1.2.1	Primary Fate and Transport Mechanisms in Soil	101
6.1.2.2	NAPL Migration in unsaturated zone	105
6.1.3	Soil Sampling Techniques	109
6.1.4	Soil Sampling for Direct Contact Exposure Considerations.....	118
6.1.4.1	Sampling Design Example	118
6.1.5	Soil Solid Sampling – Assessing Vertical and Lateral Extent of Contamination.....	121
6.1.6	NAPL Investigation	124
	Important Information You Shown Know after Reading Section 6.2	127
6.2	Soil Vapor Sampling	128
6.2.1	Soil Vapor Generation and Transport Mechanisms.....	129
6.2.1.1	Biological Decomposition	129
6.2.1.2	Chemical Decomposition	129

October 2014 ADEQ Waste Programs Division
Site Investigation Guidance Manual

6.2.1.3	Physical Decomposition	129
6.2.1.4	Transport Mechanisms	130
6.2.2	Soil Vapor Sampling Techniques	133
6.2.2.1	Active Soil Vapor Surveys	133
6.2.2.2	Passive Soil Vapor Surveys.....	137
6.2.3	Applying Soil Vapor Survey Sample Results	138
6.2.3.1	Use of the Three Phase Partitioning Equation.....	139
6.2.3.2	Soil Solid Versus Soil Vapor Sampling – an example.....	141
6.2.4	Reference Websites.....	143
6.2.5	Other Reference Used	143
	Important Information You Should Know after Reading Section 6.3	144
6.3	Groundwater Sampling	145
6.3.1	Aquifer Types	146
6.3.2	Groundwater Contaminant Transport	147
6.3.2.1	Processes Controlling the Movement of Dissolved Contaminants	148
6.3.2.2	Contaminant Characteristics Affecting Fate and Transport	149
6.3.3	Well Construction	153
6.3.3.1	Monitor Well Construction Requirements	154
6.3.3.2	Special Well Construction Requirements.....	154
6.3.3.3	Monitor Well Installation Vertical Cross Contamination Considerations	155
6.3.3.4	Other Monitor Well Installation Considerations	156
6.3.4	Monitor Well Placement	159
6.3.4.1	Vertical Extent at the Source Area	160
6.3.4.2	Lateral Extent of the Groundwater Contaminant Plume	160
6.3.4.3	Example of Monitor Well Placement	162
6.3.5	Groundwater Monitoring	167
6.3.5.1	Groundwater Elevation Measurements	167
6.3.5.2	Groundwater Purging Prior to Sampling.....	169
6.3.5.3	Groundwater Sample Collection Methods	172
6.3.5.4	Monitoring Parameters	175
6.3.6	RCRA Subtitle C and D Sites – Background and Detection Monitoring	176
6.3.7	Surface Water Investigation.....	176
6.3.8	Other References Used.....	177
	Important Information You Should Know after Reading Section 7.0	178

Section 7.0 Additional Topics Integral to Proper Investigations	179
7.1 Behavior of Organic Contaminants in the Subsurface	179
7.1.1 Introduction.....	179
7.1.2 Definitions.....	179
7.1.3 Distribution of Contaminant Mass in the Soil, Water, and Air Phases...	180
7.1.4 Calculation of Concentrations.....	186
7.1.5 Retardation of an Organic Chemical in Groundwater	188
7.1.6 Effect of Equilibrium Partitioning on Groundwater Cleanups	189
7.1.7 Behavior of NAPLs and Effect on Mass Distribution Equations	193
7.1.7.1 NAPL behavior in the subsurface:	193
7.1.7.2 NAPL Mobility.....	194
7.1.7.3 Effect of NAPLs on Mass Distribution Equations	195
7.2 Geochemical Conditions in Groundwater	197
7.2.1 Organics	197
7.2.1.1 Terminal Electron Acceptors (TEA)	198
7.2.1.2 Degradation By-Products and other Indicators	200
7.2.2 Metals & Radionuclides.....	201
7.2.3 Other Reference Used	204
References.....	205

List of References

References	206
------------------	-----

List of Appendices

Appendix A – CSM Checklist.....	212
---------------------------------	-----

List of Figures

Figure 1.1	Aquifer Materials.....	20
Figure 1.2	Arizona Physiographic Provinces.....	21
Figure 1.3	Colorado Plateau geology.....	22
Figure 1.4	Permeability ranges for aquifer materials.....	23
Figure 1.5	Profile of a Basin and Range Aquifer.....	24
Figure 1.6	Major Aquifers	29
Figure 1.7	Human Activity Influencing Groundwater Conditions	32
Figure 3.1	Typical Evolution of the Conceptual Site Model	48
Figure 3.2	Elements of a Conceptual Site Model	51
Figure 4.1	Exposure Pathway Category Illustration	60
Figure 4.2	Conceptual Site Model – Exposure Pathway Evaluation	61
Figure 4.3	Conceptual Site Model – Exposure Pathway Illustration.....	62
Figure 5.1	The Data Quality Objective (DQO) Process	77
Figure 5.2	The Three Legs of the Triad Approach	79
Figure 5.3	Comparison of Non-Dynamic Approach versus the Triad Approach	79
Figure 5.4	Exposure area DUs	88
Figure 5.5	Source Area DU Example.	89
Figure 6.1	Typical Soil Boring Log.....	101
Figure 6.2	Depiction of “trapped” NAPL Phase.....	107
Figure 6.3	Penetrating Probe Sampler	110
Figure 6.4	Split Barrel (Spoon) Sampler	111
Figure 6.5	Thin-Walled Tube (Shelby Tube) Sampler	112
Figure 6.6	Miniature Core Sampler	114
Figure 6.7	Modified Syringe Sampler	115
Figure 6.8	Hand Auger	117
Figure 6.9	Recommended Minimum Soil Sampling (≤ 5000 sq. ft.)	120
Figure 6.10	Recommended Minimum Soil Sampling (>5000 sq. ft.)	121
Figure 6.11	Soil Concentration versus Time	123
Figure 6.12	Soil Matrix Components	128
Figure 6.13	Unsaturated zone/Atmosphere Interactions.....	130
Figure 6.14	Molecular Diffusion of Soil Vapor.....	131
Figure 6.15	Low Pressure Zone at SVE Well Screen	132
Figure 6.16	Through-the-rod sampling technique	135
Figure 6.17	Soil Vapor Probes.....	135
Figure 6.18	Monitoring Well Types for Soil Vapor Samples.....	136
Figure 6.19	Sorbent strip in flux chamber	137
Figure 6.20	Installation of a passive soil vapor sampler.....	138
Figure 6.21	Passive Soil Vapor Survey Map	138
Figure 6.22	Different Sample Types, Different Conclusions.	142
Figure 6.23	Radial vapor diffusion.	146
Figure 6.24	Aquifer Types.	147
Figure 6.25	Contaminant Dispersion in Contaminant Plumes.....	149
Figure 6.26	Chemical Properties Affect on Flow & Transport of Contaminants	152
Figure 6.27	Improper Monitor Well Construction.....	156

Figure 6.28	Incomplete Historical Data Collection	157
Figure 6.29	Inaccurate Conclusion on Source Area	157
Figure 6.30	Locating zones of Higher Dissolved DNAPL Concentrations.....	158
Figure 6.31	Incomplete Characterization of the Subsurface.....	159
Figure 6.32	Monitor Well Network Design Example.....	163
Figure 6.33	Cross Section of Monitor Well Network Design	165
Figure 6.34	Cross Section of Monitor Well Network Design	166
Figure 6.35	Oil-Water Interface Probe	168
Figure 6.36	Peristaltic Pump Head	173
Figure 6.37	Bailer Types.....	174
Figure 7.1	Site Model of Terminal Electron Acceptor (TEA) Zones	199

List of Tables

Table 1.1	National Secondary Drinking Water Standards.....	27
Table 2.1	Program Weblinks	42
Table 2.2	Weblinks to Arizona's Cleanup Standards, EPA Region 9 Screening Levels and MCLS	43
Table 4.1	Exposure Pathway Element Examples	60
Table 4.2	Chemical and Site Specific Factors	64
Table 4.3	Example Potential Exposure Points.....	70
Table 5.1	Triad Approach Process Overview	81
Table 5.2	Direct Sensing and Field Generated Real Time Measurement Technology...	81
Table 5.3	Recommended Analysis Methods	95
Table 5.4	Chemicals to be included on target compound list.....	95
Table 6.1	USCS Symbol chart	98
Table 6.2	Soil Moisture Descriptions	99
Table 6.3	Relative Density Field Tests	99
Table 6.4	Consistency Tests	99
Table 6.5	Organic Carbon Partition Coefficient.....	103
Table 6.6	Determinant, Inferential, and Suggestive Indications of DNAPL Presence.	108
Table 6.7	Applying Soil Vapor Sample Survey and Their Results	139
Table 7.1	Solubility Values for Selected Chemicals	196

Important Information You Should Know after Reading Section 1.0 – Introduction to Arizona Water Issues:

1. [Sources of drinking water for major metropolitan areas of the state.](#)
2. [Arizona's three physiographic provinces.](#)
3. [The types of national standards for drinking water.](#)
4. [Some types of human activity that can contaminate groundwater.](#)

Sources of water for major metropolitan areas in Arizona:

1. Phoenix and its surrounding cities:
 - a. Several major surface water streams such as the Salt, Gila, Verde and Aqua Fria Rivers
 - b. The Central Arizona Project (CAP) Canal which is mainly supplied by water from the Colorado River and Lake Pleasant
 - c. Aquifers in and around the area
2. Tucson:
 - a. Tucson Aquifer
 - b. CAP water
3. Yuma:
 - a. Colorado River
 - b. Groundwater
4. Flagstaff:
 - a. Lake Mary (located to the southwest and fed by snowmelt)
 - b. Wells and springs (located to the north and fed by snowmelt)
 - c. Coconino Sandstone (known as the "C" Aquifer)
5. Prescott area and Yavapai County:
 - a. Private domestic water supply wells
 - b. Big Chino groundwater sub-basin (located north of Prescott)

Two types of national drinking water standards:

1. [National Primary Drinking Water Standards \(NPDWS\)](#): community water systems must comply with NPDWS by providing water to their customers that does not exceed the maximum contaminant level (MCL) of any listed contaminant.
2. [National Secondary Drinking Water Standards \(NSDWS\)](#): established only as guidelines (EPA does not enforce) to assist community water systems in managing their drinking water for aesthetic conditions, such as taste, color and odor.
***Please see Section 2.6 for discussion on Arizona Aquifer Water Quality Standards**

Arizona's three physiographic provinces:



1. Colorado Plateau: consists of layers of consolidated sedimentary rock, which form broad plateaus and mesas, separated by deep canyons.
2. Transition Zone: has geologic characteristics intermediate of the Colorado Plateau and Basin and Range.
3. Basin and Range: characterized by mountains and broad valleys that are filled with sands and gravels produced by the weathering of granite bedrock.

Human activities that can contaminate groundwater:

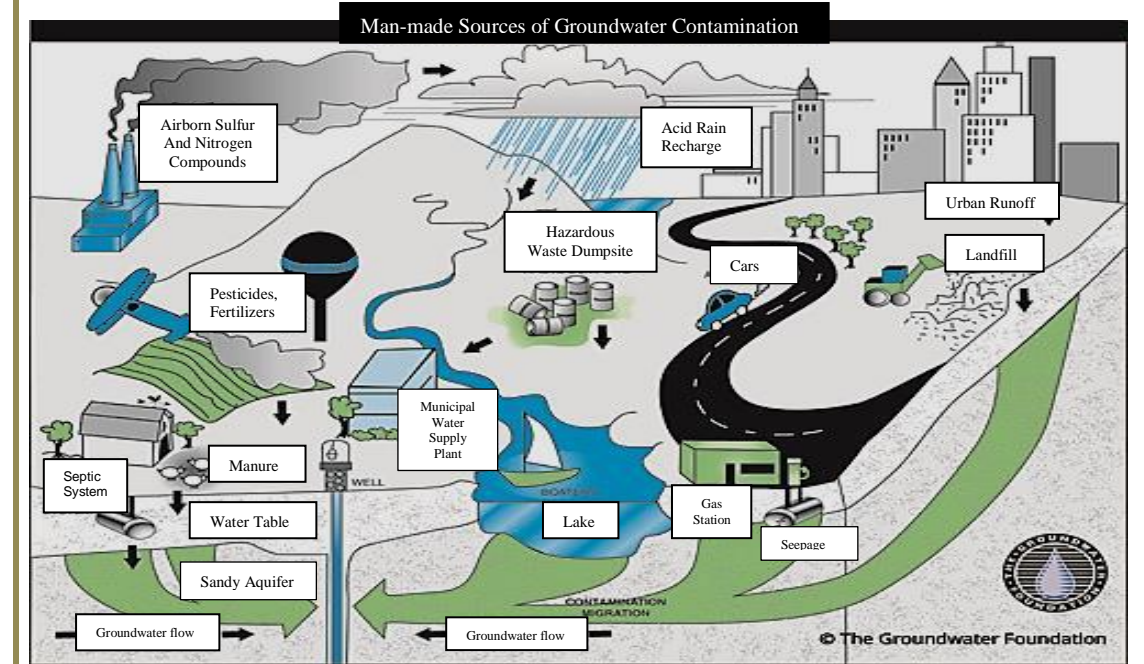

1. Anthropogenic contaminants are those chemicals that have been introduced to the environment by the activity of man. Some of those chemicals are:
 - a. Industrial chemicals;
 - b. Those derived from land use (e.g. oils and grease flushed off roadways and agricultural chemicals applied to crops).
2. In AZ, some of the industries that have contributed to groundwater contamination are:
 - a. Chemical plants;
 - b. Drycleaners;
 - c. Gas stations;
 - d. Manufacturing facilities;
 - e. Mining; and
 - f. Repair shops

Section 1.0 Introduction to Arizona Water Issues

1.1 Arizona Water Sources

There are more than 100,000 domestic use wells in Arizona. These private wells provide water to an estimated 120,000 households, with some 300,000 persons, or about 5% of the state's population. About 10-30% of the U.S. population depends on domestic wells for their water (Bartholomay et al., 2007). Information about the total number of domestic wells in the U.S. is difficult to obtain, but according to the Center for Disease Control more than 90,000 new wells were installed in the U.S. in 1998 (CDC, 1998). In Arizona, the number of new domestic wells now exceeds 3,000 each year (ADWR, 2008a). The EPA (EPA, 2008) reports that "...approximately 15% of Americans rely on their own well..." for water. Water from domestic wells that service less than 15 connections or 25 people is not subject to EPA drinking water regulations, and undergoes no governmental quality tests for potability in Arizona (note: New Jersey is one of the few states requiring domestic wells be tested with any real estate property transaction).

Although groundwater is considered a renewable resource in regions with plentiful rain and snow, it is considered a non-renewable resource in the arid West and many other parts of the U.S. and the world where pumping exceeds recharge in many aquifers. There is insufficient rainfall in Arizona's dry climate to recharge the aquifers and to keep pace with increased pumping. This will continue to produce significant overdraft in many aquifers in the state. Age-dating estimates the time elapsed since the water fell as rain or snow before it percolated to the groundwater. For example, groundwater in the Tucson basin has been age-dated to be between 300 and 8,000 years old. In the San Pedro River basin, the groundwater has been age-dated to over 12,000 years old (modified from Artiola and Uhlman, 2009).

1.1.1 Local Water Sources

Phoenix and its surrounding cities – Chandler, Mesa, Tempe, Glendale, Scottsdale, and Peoria – have diverse sources of fresh water. These include several major surface water streams (including the Salt, Gila, Verde, and Agua Fria Rivers), and more recently, the Central Arizona Project [CAP] canal. Dams located on these rivers, which flow from the mountains north and east of Phoenix, form reservoirs that provide a steady supply of water. Surface water and CAP water provide about 57% of the Phoenix area water supply. However, if drought persists and the pattern of snow fall and precipitation changes, it is unlikely that these surface water resources will increase in the near future.

Phoenix and its surrounding communities also supplement their water needs by pumping from several large aquifers. However, large portions of the groundwater along the Salt and Gila Rivers are high in salinity (> 3000 mg/L TDS). From 2007-2010, on average, groundwater supplied 3% of the City of Phoenix's water supply (2011 City of Phoenix

Water Resource Plan). Central Arizona Project water and reclaimed wastewater (treated effluent) are used for irrigation or to recharge local groundwater aquifers for future use.

Tucson has no surface water (streams, lakes, or rivers) supplies. These sources were quickly depleted during the first part of the twentieth century, mostly by local groundwater pumping which lowered the water table and depleted river base flow. Although groundwater levels have dropped in the center of the Tucson basin by more than 200 feet over the past fifty years, growth has been sustained by the continued use of groundwater and CAP water. Since 1996, CAP water that is not used directly is discharged into groundwater recharge basins and stored aquifers. This has slowed the lowering of groundwater elevations in the Tucson Aquifer. In recent years, some portions of the aquifer groundwater levels have risen as a result of less reliance on GW pumping and more utilization of recharged CAP water. Tucson also requires the use of treated effluent to irrigate parks and golf courses and is using 11,000 acre feet of effluent directly; the excess effluent is discharged into the Santa Cruz River.

Yuma obtains drinking water primarily from the Colorado River and holds the oldest water rights on the river. Groundwater is used locally for irrigation, blended with surface water for municipal supply, and used occasionally for emergency supply. Most of the water diverted from the Colorado River in Yuma is used for agriculture, while drainage wells are used so that the land does not become water-logged from irrigation application.

Flagstaff has diverse but limited sources of water. The primary sources are Lake Mary (located to the southwest), and wells and springs (located to the north). However, both sources are fed by snowmelt, which can vary greatly from year-to-year. Groundwater is also available from the Coconino Sandstone (known as the “C” Aquifer), but it is deep (1,200 to 1,600 feet below land surface) and, consequently, expensive to pump. Presently, about 70% of Flagstaff’s water demands are met by groundwater. In 2005, Flagstaff purchased the Red Gap Ranch east of the city as a potential location for new well-field development. This city is also utilizing reclaimed water to irrigate public areas like schools, parks, and golf courses (ADWR, 2008b).

The Prescott area and Yavapai County have the unique distinction of having more exempt, private domestic water supply wells than any other area in Arizona. Currently, over 30% of all new wells drilled in Arizona are in Yavapai County, with the greatest concentration of these wells in the Prescott area. The City of Prescott obtains most of its water supply from groundwater wells. Arizona law allows the transportation of groundwater pumped from the Big Chino groundwater sub-basin, located north of the City, into the Prescott AMA. The City of Prescott has purchased the Big Chino Ranch to supplement its water supply. While the law allows pumping of up to 14,000 acre-feet of groundwater a year, the actual permitted volume has not yet been determined (Yavapai County, 2008). (modified from Artiola and Uhlman, 2009)

1.2 Physiographic Provinces/Aquifers in Arizona

An aquifer is an underground geologic formation capable of producing (yielding or transmitting) usable quantities of water to a well or spring. Depending on the geologic formation, water is typically held in interconnected pores and void spaces between grains of clay, silt, sand, and gravel or in subsurface fractures and cracks of rocks (Figure 1.1). Aquifer material types include consolidated and unconsolidated rock materials, examples of which range from the unconsolidated alluvial sands and gravels of river valleys and southern deserts, to the dense consolidated basalt of the Mogollon Rim.

In these two aquifer types, groundwater is filtered through pores (porous flow) or through fractures and cracks (fractured flow) and/or in a combination of these flow types. Water flow through fractures can rapidly transmit contaminants through the subsurface, as there is little opportunity for natural filtration of pollutants. It is important to understand which flow type is prevalent in your aquifer to protect your water supply from contamination.

Arizona's geologic history resulted in the formation of three physiographic provinces: the Colorado Plateau; the Central Highlands Region (also known as the Transition Zone between the other two provinces); and, the Basin and Range Province, see Figure 1.2 (modified from Artiola and Uhlman, 2009).

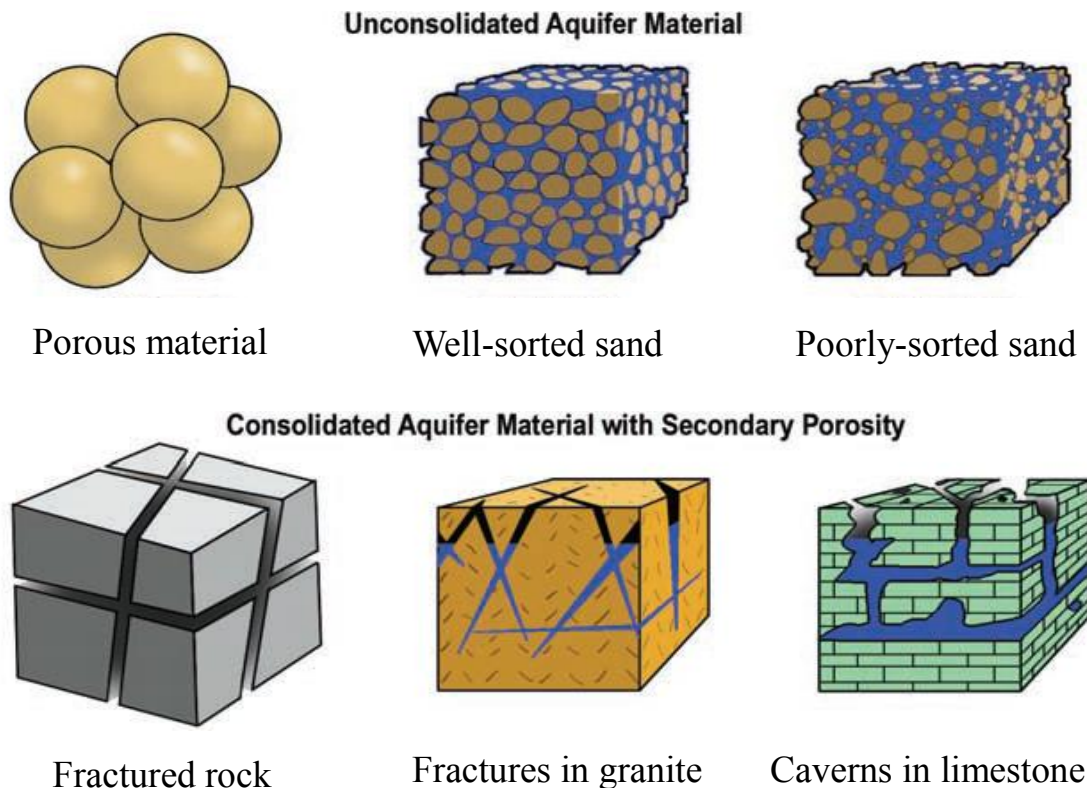

Figure 1.1 Aquifer Materials (Artiola and Uhlman, 2009)



Figure 1.2 Arizona Physiographic Provinces

1.2.1 Colorado Plateau

The Colorado Plateau consists of layers of consolidated sedimentary rock, which form broad plateaus and mesas, separated by deep canyons. The numerous sedimentary rock layers are visible in the Grand Canyon walls, and each rock layer has unique aquifer characteristics, dependent on the number of sedimentary bedding planes, fractures and cracks, and interconnected rock fractures. Some sedimentary rocks maintain their original pore spaces (porosity), such as the Coconino Sandstone (see Figure 1.3) which originated from white-sand dunes. In some places, these layers of sedimentary rock contain caverns and caves, for example in the Redwall Limestone. These caves were produced by large groundwater flows through rock fractures, which then dissolved the rock, forming large

caverns. Therefore, a well constructed in the consolidated sedimentary aquifers of the Colorado Plateau may yield little water if the borehole does not intercept sufficient fractures transmitting water, or in the extreme, the well may yield sufficient volumes of groundwater that has had little filtering (modified from Artiola and Uhlman, 2009).

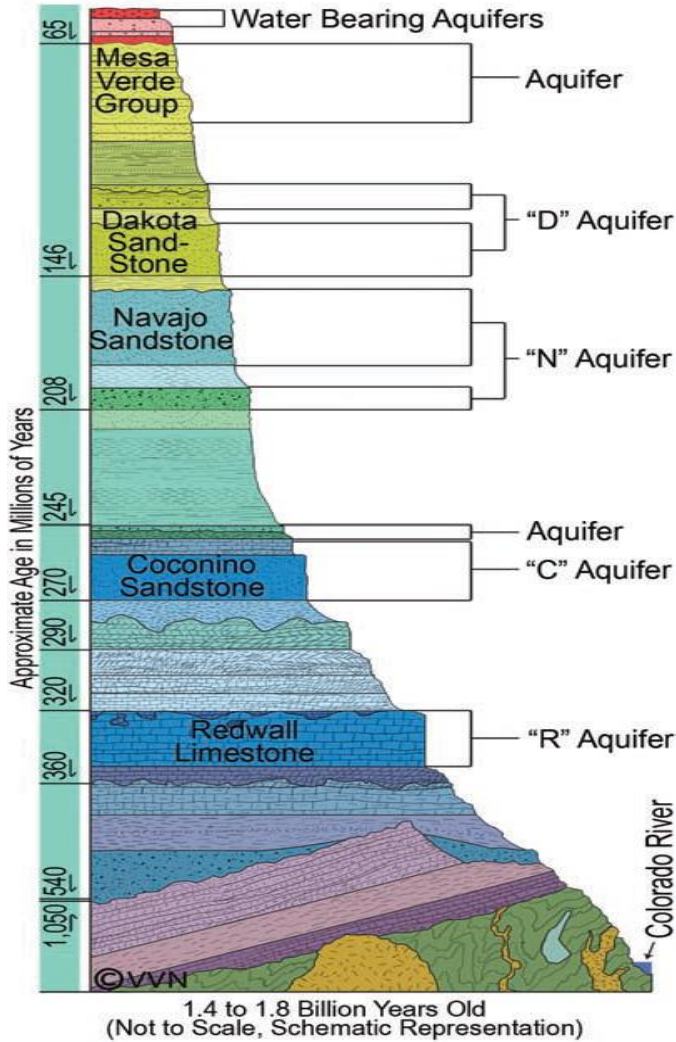

Figure 1.3 Colorado Plateau geology showing aquifers available for potential water supply (modified from Harshbarger et al., 1966; and, Kamilli and Richard, 1998)

1.2.2 Transition Zone

The southern boundary of the Colorado Plateau is the Mogollon Rim, a steep ridge formed by erosion after the plateau was uplifted. Large volcanoes, such as the San Francisco Peaks, are present along the Mogollon Rim bordering this Transition Zone or Central Highlands Region. This zone cuts across central Arizona, (see Figure 1.2) separating the Basin and Range Province from the Colorado Plateau, and exhibits geologic characteristics intermediate between the two. In addition to the volcanoes along the northern margin, it contains mountainous regions (highlands) cut by major canyons and valleys filled by unconsolidated sediments such as in the Verde Valley.

The amount of water produced by wells developed in these valleys will vary depending on the grain-size of the aquifer material – fine-grained silts and clays will yield less water than the more porous coarse-grained sands and gravels. Wells in the dense fractured volcanic basalt rocks will also vary in yield depending on the number of water-bearing fractures intercepted by the well borehole and permeability (see Figure 1.1 and Figure 1.4) (modified from Artiola and Uhlman, 2009).

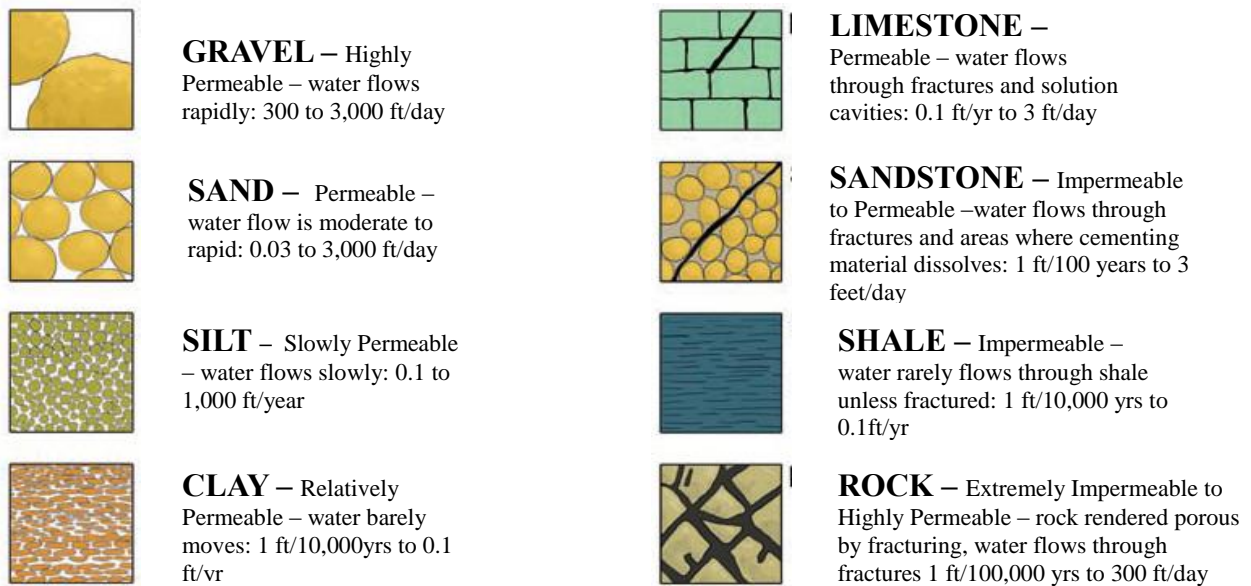

Figure 1.4 Permeability ranges for aquifer materials (Artiola and Uhlman, 2009)

1.2.3 Basin and Range

This province of southern and western Arizona is where the earth's crust was stretched and broken by numerous faults so that mountain ranges and basins (broad valleys) were formed by the vertical displacement of large consolidated blocks of rock. From mountain top to the valley basement, the average displacement has been estimated at approximately 10,000 feet, with the valleys filled by up to 7,000 feet of gravel, sand, and silt.

The sediments or alluvial materials that fill these valley basins originate from the mountains above, and typically consist of sands and gravels produced by the weathering of granite rock. The valleys are filled with materials produced by the action of erosion and transported by rivers and streams (Figure 1.5). Often, impermeable geologic barriers blocked the basins from forming rivers that would drain the basin and thus created lakes. In these cases, the valley fill may include lake deposits of silt and clay, and occasionally salt. Wells completed in the granites and other rocks of the mountain ranges bordering the alluvial valleys will vary in yield, depending on the number of water-bearing rock fractures intercepted by the well borehole. Note that local geology may vary from the generalizations made above.

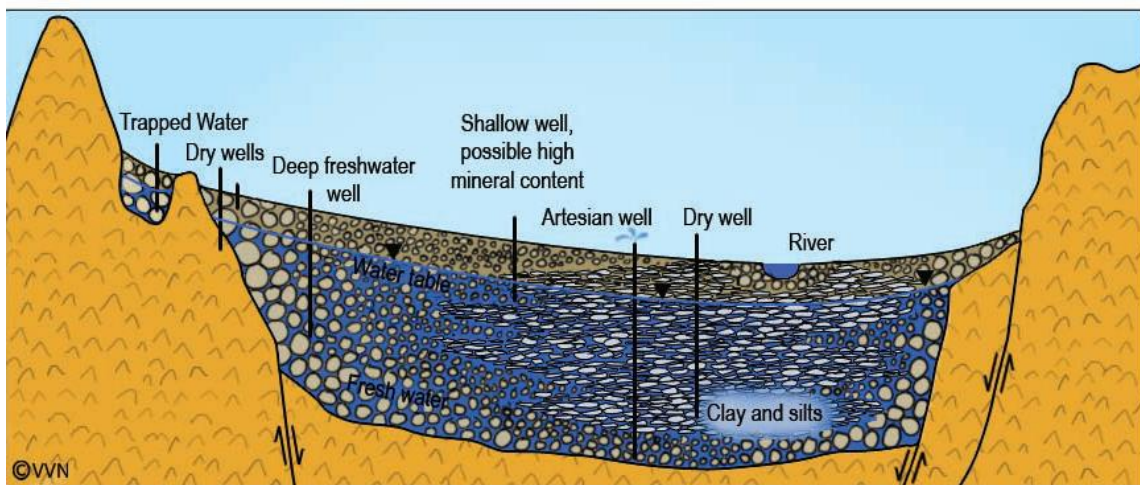

Figure 1.5 Profile of a Basin and Range Aquifer (Artiola and Uhlman, 2009)

Major agricultural areas of the state, as well as the cities of Phoenix and Tucson, are located in the Basin and Range province. Increasing groundwater pumping continues to lower water table elevations, which has resulted in land subsidence in some locations. Because of dropping water tables and local geology, wells in these sediments may require drilling to excessive depths to reach water-bearing zones. For example, in some locations within the San Pedro Valley, domestic water wells must drill through nearly 400 feet of the St. David Clay Formation to find water-bearing sands and gravels.

Across Arizona, pockets of alluvial sands and gravel, and lenses of ancient river gravel channels now buried in clay may result in finding water where none had been expected. In addition, the depth to water and thickness of the water saturated zone of the aquifer, and aquifer permeability, will control the ability of a well to yield sufficient volumes of water (modified from Artiola and Uhlman, 2009).

1.3 Contaminants in Water

Contaminants (or pollutants) fall into three categories: those of natural origin, those of natural origin but concentrated by human activities and those human-made and introduced into the environment. Water sources may also have unwanted but naturally occurring toxic elements like arsenic that may naturally concentrate to toxic levels in certain geologic settings. When naturally occurring arsenic is found in a drinking water source at concentrations above National Primary Drinking Water Standards (NPDWS), the water is considered to be “contaminated” with arsenic.

Human activities can also contaminate natural waters with excessive levels of minerals or pollutants. These activities include agricultural and industrial release of pollutants; improper disposal of municipal and animal wastes into air, soil, and surface and groundwaters; and transportation and recreation on air, land, and water. The types and concentrations of contaminants that can be tolerated in drinking water without harm to human health are set by the EPA.

Human-made contaminants are also commonly referred to as pollutants. These include synthetic organic chemicals such as agricultural pesticides, industrial solvents, fuel additives, petroleum products, plastics, and many other chemicals. Unfortunately, many of these chemicals are ubiquitous (present everywhere) in our environment due to their extensive use in modern society. In addition, microbial pathogens derived from human and animal waste become pollutants when improperly disposed of, and can adversely affect the quality of water resources (modified from Artiola and Uhlman, 2009).

1.3.1 Drinking Water Guidelines and Standards

The EPA sets National Primary and Secondary Drinking Water Standards in collaboration with community water system organizations, scientists, state and local agencies, the public, and others. States and Native American Communities facilitate implementation of these standards by regulating public and private water systems. Standards are published in the Code of Federal Regulations. Drinking water standards are always evolving as new analytical methods are developed, scientific information becomes available, and new priorities are set in response to the potential health effects of contaminants.

In Arizona, these standards apply to “community water systems,” which are systems that serve at least 15 connections used by year-round residents of the area served, or that regularly serves at least 25 year-round residents. Domestic wells that serve water below these limits are not required to comply with the drinking water quality standards. In Arizona, wells equipped with a pump that pumps less than 35 gallons per minute and serve a household (or several households) are private domestic wells and are not required to monitor water quality. For that reason it is important for well owners to be aware of drinking water guidelines and to test their water quality against those standards required for community water systems (modified from Artiola and Uhlman, 2009). Please see Section 2.6 for discussion on Arizona’s Aquifer Water Quality Standards.

Primary Drinking Water Standards

The EPA considers many issues and factors when setting a standard. These include current scientific data, availability of technologies for the detection and removal of contaminants, the occurrence or extent of a chemical in the environment, the level of human exposure, potential health effects (risk assessment), and the economic cost of water treatment.

Community water systems must comply with NPDWS by providing water to their customers that does not exceed the MCL of any listed contaminant. Contaminants listed as NPDWS are known to have an unacceptable human health and/or environmental risk, if found in concentrations greater than their MCLs. Additionally, when water sources are treated by community water utilities, they must use EPA-mandated or EPA-accepted water treatment methods to treat below the primary MCL.

Primary contaminants regulated under the NPDWS, are divided into six groups, inorganic contaminants (such as arsenic and lead), organic chemical contaminants (such as insecticides, herbicides, and industrial solvents like trichloroethylene or TCE), water disinfectants (such as chlorine and chloramines), disinfection by-products (such as chloroform), radionuclides (such as uranium) and microorganisms (such as Giardia and intestinal viruses). The complete list of these contaminants, including the MCL allowable in a drinking water supply, can be found on the [EPA website](#) (modified from Artiola and Uhlman, 2009).

Secondary Drinking Water Standards

EPA has established National Secondary Drinking Water Standards (NSDWS) that set non-mandatory water quality standards for 15 contaminants, as shown on Table 1.1. EPA does not enforce Secondary Maximum Contaminant Levels (SMCL). They are established only as guidelines to assist community water systems in managing their drinking water for aesthetic considerations, such as taste, color, and odor. These contaminants are not considered to present a risk to human health, and community water systems are not required to reduce these chemicals below the SMCL. However, water utilities control the levels of these chemicals in the water in order to prevent tap water odor and taste-related customer complaints.

If well water exceeds the SMCL for any listed contaminant in Table 1.1, consider water treatment to bring your water supply within aesthetic considerations. A discussion of commonly found contaminants follows (modified from Artiola and Uhlman, 2009).

Table 1.1 National Secondary Drinking Water Standards. The Primary Standard, or MCL, is also shown for copper and fluoride. (Artiola and Uhlman, 2009)

Contaminant	Secondary Standard	Primary Standard
Aluminum	0.05 to 0.2 mg/L	
Chloride	250 mg/L	
Color	15 (color units)	
Copper	1.0 mg/L	MCL = 1.3 mg/L
Corrosivity	Noncorrosive	
Fluoride	2.0 mg/L	MCL = 4.0 mg/L
Foaming Agents	0.5 mg/L	
Iron	0.3 mg/L	
Manganese	0.05 mg/L	
Odor	3 threshold odor number	
pH	6.5-8.5	
Silver	0.10 mg/L	
Sulfate	250 mg/L	
Total Dissolved Solids	500 mg/L	
Zinc	5 mg/L	

Total Dissolved Solids (TDS)

This measurement combines most dissolved minerals found in water sources into one value. These include sodium, potassium, calcium, magnesium, chloride, sulfate, and carbonates. According to the NSDWS, drinking water should not have more than 500 mg/L of TDS. Still, potable water that has a higher TDS is not necessarily unhealthy. However, high TDS water may cause deposits and/or staining, and may have a salty taste.

pH

This value measures the active acidity in water. The pH of water is important in controlling pipe corrosion and some taste problems. The recommended pH range is 6.5–8.5.

Taste

Note that TDS and pH values do not determine the proportions of the major minerals found in drinking water sources. However, the mineral composition of water may affect its taste. For example, water with a TDS of 500 mg/L composed of table salt would taste slightly salty, have a slippery feel, and be called soft water. Whereas, water with the same TDS value but composed of similar proportions of table salt, gypsum, and calcite would have a more acceptable (less salty) taste and feel less slippery due to its greater water hardness. Salty taste can be reduced by limiting the amounts of chloride and sulfate ions in potable water to less than 250 mg/L each.

Organic Matter

Water color, odor, and foaming are affected by the presence of natural organic matter (NOM) substances often found in surface water, but much less frequently in groundwater supplies. This organic matter is derived from vegetation, such as leaves, that fall into

surface water. Water soluble natural organic constituents impart taste and color to the water, similar to what occurs when tea leaves are brewed in water.

Metals and Fluoride

The NSDWS also include recommended levels for aluminum, zinc, iron, manganese, copper, and fluoride (not a metal). Other metals that are considered more toxic, like lead, chromium, cadmium, and mercury, are regulated under the NPDWS. In general, these elements are found in trace quantities (less than 1 mg/L) in fresh waters. Iron, copper, and zinc, if present above NSDWS, can impart a metallic taste to water and cause staining. Note that copper and fluoride also have NPDWS regulatory levels (MCLs) that must not be exceeded in drinking water (Table 1.1.) (modified from Artiola and Uhlman, 2009).

1.3.2 Naturally Occurring Well Water Contaminants

In addition to elevated total dissolved solids, the most common constituents found in Arizona groundwater in concentrations above drinking water standards are arsenic, fluoride, gross alpha radiation, and nitrate. Nitrate contamination, although it can be natural, is usually due to either agricultural practices (excessive fertilizer use and/or poor irrigation practices), or failing septic systems that allow contaminated waters to drain into the aquifer. Ammonium and phosphorus contamination, much less common in Arizona aquifers, are also linked to septic sewage water contamination. Naturally occurring groundwater contaminants are dependent on aquifer geology, and are discussed below.

An important consideration within the Basin and Range Province is how geologic forces have influenced the quality of water held within the aquifers. The Basin and Range could resemble an egg carton filled with sand, with many isolated basins and drainage systems that could not reach the sea, generating large inland seas – such as the Great Salt Lake in Utah – that concentrated the salts leached from the soils as water evaporated. Large evaporite deposits of salt are common within valley aquifers within the Basin and Range province, and elevated concentrations of chemical constituents such as boron, sodium chloride (salt) and calcium sulfate (gypsum) are often found in the deeper alluvium zones of the these basin aquifers.

In the Gila River Valley, for example, deep petroleum exploration boreholes have been drilled throughout the region. Although oil was not found, salt brines are now discharging to the land surface through improperly sealed abandoned boreholes, and the local water quality has been impacted. Thick layers of salt are found deep throughout the entire valley.

Today, the Willcox Playa (near Willcox) is an example of the formation of evaporite deposits. Because the basin is not drained, salts are accumulating on the land surface. However, the geologic barrier that stops the flow out of the Willcox Basin is relatively recent in geologic time, and because of this only the shallow groundwater is salty. Water quality in the deep aquifer of the Willcox Basin is excellent.

Figure 1.6 shows those portions of the state where groundwater has been reported to be saline, either due to deep layers of salt originating from the depositional setting, playa formation, or in agricultural areas where evaporation of irrigation water concentrates naturally occurring salts (modified from Artiola and Uhlman, 2009).

Figure 1.6 Major Aquifers and regions of saline groundwater (modified from WRRC, 2002).

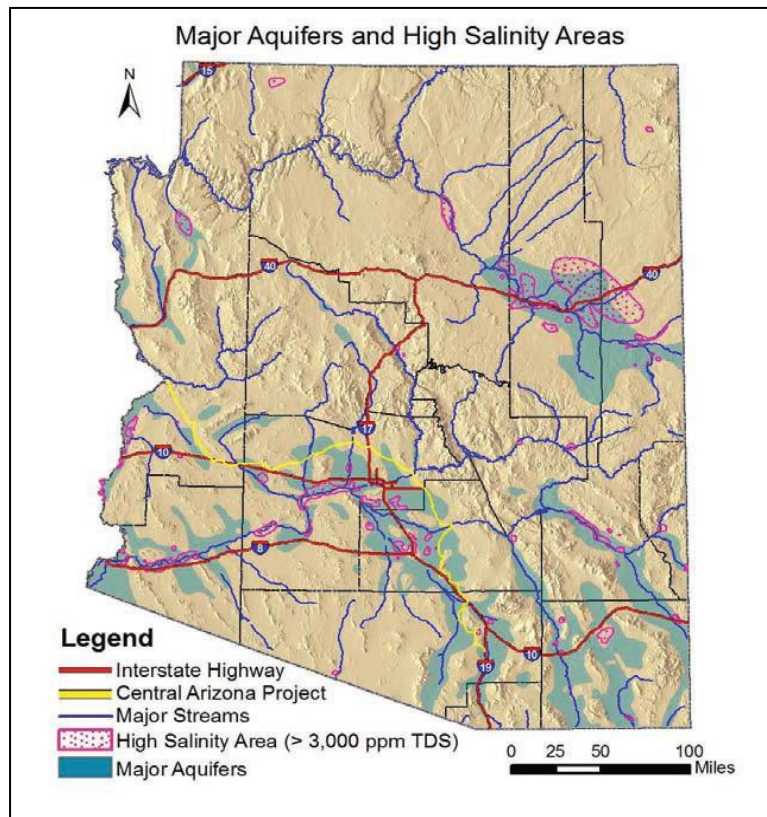

Arsenic

Three significant geologic sources of arsenic are found in Arizona, and elevated concentrations of arsenic are found in each of the three geologic provinces. In geologically ancient Arizona, magma pushed upward into the host rock and hardened into granitic plutons and mineralized veins of ore containing copper, silver, gold, and arsenic.

In Arizona, regions of granite bedrock with valuable gold ore often contain elevated concentrations of arsenic. Gold prospectors have found new mine sites by measuring the concentration of arsenic in rivers and streams, using arsenic as a pathfinder as they move upstream following greater and greater concentrations of arsenic until the source is found – and gold is discovered. In addition, Basin and Range aquifers consisting of alluvium eroded from granite bedrock may also contain arsenic.

The geology of northern Arizona and southern Utah consists of layers of ancient sedimentary rock, including the Redwall Limestone and the sandstone formations that can be seen in the exposed cliffs of the Grand Canyon, (see Figure 1.3). These sedimentary rocks are found layered across the Colorado Plateau province of northeastern Arizona and many water supply wells tap these formations. An extensive cave system was formed over 325 million years ago within the Redwall Limestone, similar to the limestone caves of Kartchner Caverns near Benson. Over geologic time, the weight of overlying rock layers that had accumulated on top of the caves in the Redwall Limestone

collapsed, resulting in thousands of feet of vertical collapsed chimneys or drain pipes that filled with rock rubble in the Supai Sandstone and above. These pipes acted as drains, allowing groundwater, which contained dissolved chemicals from the adjacent sedimentary rock to concentrate. Arsenic, various metals, and uranium were deposited and concentrated within these pipes, which are found throughout the Supai Sandstone formation (Kenny, 2003). Wells constructed within the Supai Sandstone in the Colorado Plateau have elevated levels of dissolved arsenic in the groundwater, as well as uranium and other radioactive elements, discussed below.

Arsenic is also found in the Central Highlands Transition Zone of Arizona (see Figure 1.2). Within the past 2 to 5 million years, the Verde Valley of Yavapai County was formed as earth crust shifts produced faults that separated the Colorado Plateau from the Basin and Range. The arsenic rich Supai Sandstone formation was eroded and re-deposited in the Verde Alluvium Formation, which now forms the aquifer of the Big Chino and Verde Valley. The highest concentration of arsenic in groundwater in Arizona was found near Paulden in the Verde Valley, with a concentration of 2,900 parts per billion in a private, domestic (exempt) well. The EPA drinking water MCL for arsenic is 0.010 mg/L, or 10 parts-per-billion.

Because the solubility of arsenic in water is a function of its mineral form, water pH, and oxygen content, any change in the chemistry of an aquifer may increase or decrease arsenic concentrations. An example is the introduction of oxygen as groundwater elevations dropped due to drought in the Verde Valley. The change in geochemistry resulted in arsenic concentrations increasing, and consequently in arsenic poisoning of livestock (Foust et al., 2003) (modified from Artiola and Uhlman, 2009).

Radioactive Elements

Radioactivity is the release of energy from within atoms. Certain atom structures are inherently unstable and spontaneously break down (decay) to form more stable atoms. For example, the potassium-40 isotope decays very slowly (half-life of 1.25 billion years) but eventually becomes the element argon. Because potassium is a significant component of clay minerals, it is generally true that all clay, including clay soils, bricks and pottery made from clay soils, and living organisms (animals and plants) that contain potassium, are all slightly radioactive.

In Arizona, the most common source of radioactivity is dissolved uranium and dissolved radon gas. As mentioned previously, uranium was deposited and concentrated within collapsed breccia pipes above the Redwall Limestone formation. Uranium mines are found throughout the Supai Sandstone Formation (Kenny, 2003). The water from wells within the Supai Sandstone in the Colorado Plateau show elevated concentrations of uranium, sometimes exceeding the MCL of 0.030 mg/L or 30 parts-per-billion.

Radioactive minerals containing the elements uranium and thorium (760 million and 4.46 billion years half-life, respectively) are also found in some Arizona granites. These elements are unstable and decay, eventually becoming a new element called radium (half-life of 1,620 years), which then decays to the element radon (half-life of 3.8 days). Radon is strongly radioactive as it emits high energy alpha particles. Unfortunately, the radon

element is an odorless, colorless, tasteless gas that dissolves in groundwater and may migrate upward through the soil, eventually dissipating into the atmosphere. If radon gas is trapped within a structure, such as a basement, the concentration of radon gas within the closed structure may exceed health standards. The EPA estimates that 1 in 15 U.S. homes contains a high level of the gas and is considered to be the second leading cause of lung cancer in the country. The MCL for radon is 300 pCi/L.

‘Gross alpha’ is a measurement of the amount of radioactivity in water whether it is due to the decay of uranium, radium, or radon, and is a gross measurement of overall radioactivity. ‘Gross alpha’ is a common naturally occurring “contaminant” in Arizona bedrock aquifers (such as the Supai Sandstone or granite) or in alluvial aquifers composed of eroded granite. The MCL for ‘Gross alpha’ is 15 pCi/L (modified from Artiola and Uhlman, 2009).

Fluoride

Fluoride is a common mineral that is concentrated in volcanic materials, and mineral particles that contain fluoride are common in some sedimentary rocks. In Arizona, the highest fluoride concentrations are found in Cochise County (Hem, 1985); Mohave, Graham, and Greenlee Counties (ADEQ, 2005); and along the lower Gila River in Yuma County. Most of the elevated concentrations are associated with confined aquifers.

Groundwater from confined aquifers usually has not had the opportunity to mix with recently recharged water high in dissolved oxygen. Therefore, the low oxygen environment and long resident time in confined aquifers allows for fluoride naturally present in the aquifer geology to dissolve into the groundwater. Although fluoride at high concentrations may be harmful, it is essential for strong teeth and bones; many municipal water supply systems add fluoride to the water in a process called fluoridation. Excessive concentration in drinking water results in tooth mottling and discoloration. The MCL for fluoride is 4.0 mg/L.

Elevated levels of other naturally occurring constituents have been found in wells across Arizona. For example, naturally occurring hexavalent chromium (Cr^{6+}), known to cause cancer, has been found in Paradise Valley north of Phoenix and in the Detrital Valley near Kingman (Robertson, 1975). Lithium is found in the brine groundwater of the Gila Valley near Safford. Selenium and boron are also found in geologic settings with evaporite deposits, and these elements have been detected in groundwater near Kingman. Each of these constituents has known health impacts and should be avoided in high concentrations. The mineral-rich geology of our state results in elevated levels of elements such as copper, silver, zinc, manganese, and sulfate minerals, occasionally being encountered in groundwater near mining districts. Iron is found in nearly all groundwater and is responsible for iron-bacterial fouling of some wells (modified from Artiola and Uhlman, 2009).

1.3.3 Examples of Anthropogenic Contaminants

Anthropogenic contaminants are those chemicals that have been introduced to the environment by the activity of man (Figure 1.7). These contaminants include industrial

chemicals inadvertently released into the environment, those derived from land use activities such as oils and grease flushed off roadways and agricultural chemicals applied to crops. In early June of 2003, the cause of the death of aquarium fish in a home in Tucson was traced to mercury in the water supply. The single source of mercury was a broken water-level indicator, a mercury switch, within one of the wells of the water provider for the neighborhood. This isolated incident points to the fact that water contaminants can be found very close to home.

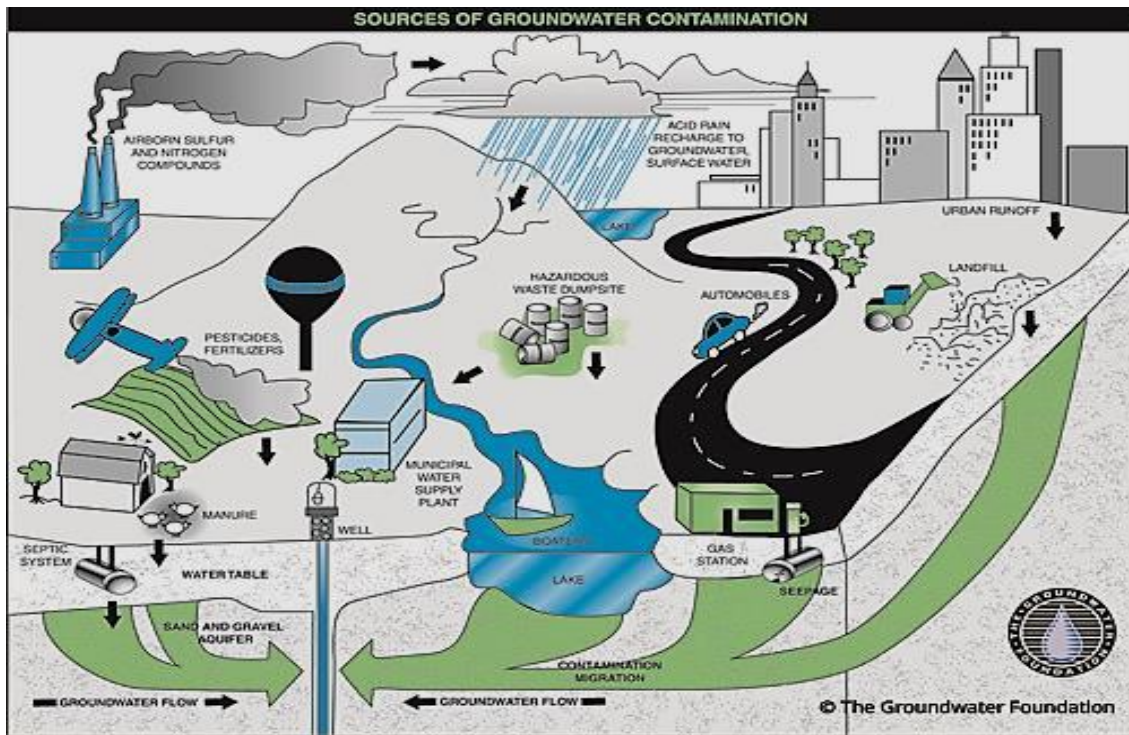

Figure 1.7 Human Activity Influencing Groundwater Conditions (The Groundwater Foundation, 2013)

A neighborhood of recently installed private domestic wells in a new subdivision in New York was tested for contaminants after concern was expressed about the proximity of a nearby landfill. All wells failed water quality testing because a dissolved industrial solvent was found. Since the solvent is also a common contaminant associated with landfills, an extensive investigation was conducted to tie the pollution to the landfill, but no link could be found. The source of water contamination was discovered to be the solvent used to glue the plastic polyvinyl chloride (PVC) pipe used to construct the wells and plumbing.

Chemical plants, manufacturing facilities, gas stations, repair shops, landfills, and mining activities all have the potential to release contaminants into the environment. Many Superfund Sites (EPA mandated environmental clean-up sites) were first discovered because domestic well owners noticed an unusual odor as they showered or an odd taste to their well water. In some cases, plumes of groundwater contamination have extended miles beyond their original source. The contaminant concentration decreases with

distance as the contaminant plume dissipates and mixes with uncontaminated water, and as it moves downgradient. Superfund Sites can be found at <http://www.epa.gov/superfund/sites/index.htm>. If there is a site in your neighborhood, you may want to follow up with the Arizona Department of Environmental Quality (ADEQ) to obtain information to determine if your water supply is at risk of contamination.

The gasoline additive MTBE (Methyl tertiary-butyl ether) was added to gasoline in the late 1970's to boost octane, to replace the toxic metal lead, and to reduce air pollution. Unfortunately, the fate of this chemical in the water environment was not fully tested before it was approved as a gasoline additive, and has since been tied to respiratory problems. Since then, this chemical has been found to be very soluble and stable (degrades slowly) and has resulted in the contamination of numerous groundwater supplies from leaky underground gasoline tanks. Today, the fate of MTBE is the subject of numerous research studies. It is now banned in California, and EPA is taking actions to reduce and eventually eliminate MTBE use (<http://www.epa.gov/mtbe/faq.htm#actions>).

Often, the most likely source of groundwater pollution in a domestic well is found near the well-head. Stored pesticides, lawn amendments, oil and grease, and failing septic systems are the most likely sources of domestic water supply pollution. Septic tank de-greasers are banned in many states because the chemicals, industrial solvents, rapidly percolate through the soils and contaminate the aquifer (modified from Artiola and Uhlman, 2009).

Pathogens

Drinking water supplies that depend on groundwater are subject to contamination by enteric waterborne pathogens. The detection of these pathogens (and other indicator organisms) may indicate fecal contamination of the groundwater. These pathogens can originate from leaking sewer lines, septic systems, or improperly protected well heads that allow contaminated surface water to drain into the aquifer along the outer well casing. Contaminated groundwater represents approximately half of the waterborne disease outbreaks documented in the United States every year.

Organisms of particular concern with respect to groundwater contamination include waterborne pathogenic human enteric viruses such as Adenovirus, Rotavirus, Hepatitis A, and Norovirus; enteric bacteria such as the pathogenic strain of *Escherichia coli* 0157:H7, *Salmonella*, *Campylobacter*, *Pseudomonas*, *Helicobacter*, *Aeromonas*, *Vibrio cholerae*, and *Shigella* spp.; protozoan pathogens such as *Cryptosporidium* and *Giardia*; and, the recently reported amoeba *Naegleria fowleri*. These organisms present a human health risk to those who ingest the water. Typical symptoms associated with an infection include acute gastroenteritis, severe cramping, abdominal pain, dehydration, and diarrhea.

In a recent study in Arizona of 188 drinking water systems and individual household wells, the waterborne amoeba *Naegleria fowleri* was reported in 29 cases (Payal, 2008). According to the Centers for Disease Control (CDC), *Naegleria* infects people by entering the body through the nose. This can occur when people use warm freshwater or untreated groundwater for activities like swimming or diving. The amoeba travels up the

nose to the brain and spinal cord where it destroys the brain tissue. Because *Naegleria* is commonly found in warmer temperatures, states within the southwest are particularly prone to its presence. Although it is alarming that this waterborne pathogen is currently being found in wells across Arizona, infections occur only by immersion in the water and do not occur as a result of drinking contaminated water.

Certain bacteria are likely to form biofilms within wells if enough nutrients are available for their survival. Occurrence could be due to the use of biodegradable oils used to lubricate pumps in addition to the high temperatures of groundwater in Arizona. The oils may act as a food source for bacteria, and other organisms, such as the amoeba *Naegleria*, may feed upon bacteria growing on the oils within these wells.

Iron bacteria thrive in groundwater with high concentrations of naturally occurring dissolved iron and are non-injurious to health. Iron bacteria are nuisance organisms that cause plugging of the pores in the aquifer and the openings of the well screen. The bacteria produce accumulations of slime within the well, and precipitate iron and manganese. The combined effect of the growth of the organisms and precipitated mineral has been reported to reduce well yield by 75% within a year in some locations (Johnson Division, 1972).

Although all of the above mentioned organisms pose a risk to human health, viral contaminants are typically considered more of a threat to groundwater than bacterial or protozoan contaminants for two reasons. First, because of the small size of viruses, they typically can be transported further into the aquifer than bacteria and can eventually reach the groundwater. Second, viruses are thought to be more persistent in the environment than their bacterial counterparts and require greater disinfection procedures to render them inactive.

Approximately one-third of the groundwater drinking wells used by utilities across the United States contained human pathogenic enteric viruses (Abbaszadegan et al., 2003). However, in another study focused specifically on groundwater supplies in Arizona, none of the 49 groundwater samples tested in seven counties across Arizona reported detection of human pathogenic enteric viruses (Karpisack et al., 2006). Although viruses were not detected, 74% of the Arizona samples exceeded at least one of the NPDWS, 80% exceeded at least one NSDWS, and 95% exceeded one parameter of either of the two standards (Marrero-Ortiz, 2007) (modified from Artiola and Uhlman, 2009).

New (Emerging) Contaminants

The EPA is always evaluating so-called “emerging” contaminants that may need to be regulated in our community water systems. Emerging contaminants include those chemical constituents, for which new analytical methods allow us to measure very small concentrations, revealing the presence of common household chemicals that were not expected to end up in our water supply. Very small concentrations of chemical fire retardants, antibiotics used in household soaps, and chemicals originating in well-known products such as Teflon®, Scotchgard™, and Gore-Tex® are being found. Of increasing concern are pharmaceuticals and personal care products (PPCPs), and many

may affect the endocrine system of living organisms (also called endocrine disruptors). Pharmaceuticals in general may be flushed through our bodies and end up in the sewer systems. A recent national survey showed that several of these chemicals are not completely removed during the treatment of wastewaters. Thus, reclaimed waters, when discharged into the environment, may affect the quality of water sources. According to EPA, PPCPs include: therapeutic and veterinary drugs, fragrances, cosmetics, sun-screens, diagnostic agents, and vitamins. See: <https://www.epa.gov/wqc/contaminants-emerging-concern-including-pharmaceuticals-and-personal-care-products>.

In addition, the EPA is evaluating other environmental contaminants for potential regulation. These include the perchlorate ion, found in rocket fuel and explosives but also naturally occurring, which has been detected in both the groundwater and surface water of several states (including Colorado River water). Although the EPA has not yet set or passed any national standards on these newly recognized contaminants, individual states may choose to have additional or stricter drinking water quality guidelines (modified from Artiola and Uhlman, 2009).

Important Information You Should Know after Reading Section 2.0 – Introduction to Guidance Manual:

1. [The different programs within ADEQ’s Waste Programs Division.](#)
2. Where to find Arizona’s environmental statutes and administrative code.
3. Where to find descriptions and listings of the cleanup standards for soil, surface water, reclaimed water and groundwater.

Different Programs within the Waste Programs Division:

1. Voluntary Remediation Program:
Through ADEQ's [Voluntary Remediation Program](#) (VRP), property owners, prospective purchasers and other interested parties investigate or clean up a contaminated site in cooperation with ADEQ.
2. Underground Storage Tanks Program:
ADEQ’s [UST Program](#) protects public health and the environment through oversight, investigation and cleanup of soil and groundwater contamination caused by releases from underground storage tanks.
3. Water Quality Assurance Revolving Fund and CERCLA Programs:
ADEQ’s [Remedial Projects Section](#) identifies, assesses and cleans up soil, groundwater and surface water contaminated with hazardous substances. The Arizona Water Quality Assurance Revolving Fund (WQARF), created under the Environmental Quality Act of 1986, is used to support hazardous substance cleanup efforts in the state. Some contaminated sites in Arizona are governed and funded under CERCLA (1980), WQARF’s federal counterpart. Department of Defense (DoD) sites are also managed in the Remedial Projects Section.
4. Hazardous Waste Program:
The [ADEQ Hazardous Waste Program](#) administers [Resources Conservation and Recovery Act \(RCRA\) Subtitle C](#) requirements for hazardous waste through Arizona’s Revised Statutes and Administrative Code. The Subtitle C regulations establish a system for controlling hazardous waste from the time it is generated until its ultimate disposal — in effect, from “cradle to grave.” To this end, there are Subtitle C regulations for the generation; transportation; and treatment, storage or disposal of hazardous wastes. In practical terms, this means regulating a large number of hazardous waste handlers.
5. Solid Waste Program:
The [ADEQ Solid Waste Program](#) administers [RCRA Subtitle D](#) requirements for solid waste through Arizona’s Revised Statutes and Administrative Code. The RCRA Subtitle D requirements focus on the management of non-hazardous solid waste, such as household garbage and non-hazardous industrial solid waste.

Weblinks to Statutes and Administrative Code:

Program Name	Weblink to Programmatic Arizona Revised Statutes	Weblink to Programmatic Arizona Administrative Code	ADEQ website program information link
Voluntary Remediation Program	http://www.azleg.gov/arsDetail/?title=49	http://apps.azsos.gov/public_services/Title_18/18-07.pdf	http://www.azdeq.gov/programs/vrp
UST Program	http://www.azleg.gov/arsDetail/?title=49	http://apps.azsos.gov/public_services/Title_18/18-12.pdf	http://www.azdeq.gov/UST
WQARF and CERCLA Programs	http://www.azleg.gov/arsDetail/?title=49	http://www.azdeq.gov/programs/waste/WQARF	http://www.azdeq.gov/environ/waste/sps/index.html
Hazardous Waste Program	http://www.azleg.gov/arsDetail/?title=49	http://apps.azsos.gov/public_services/Title_18/18-08.pdf	http://www.azdeq.gov/programs/waste-programs/hazardous-waste-management
Solid Waste Program	http://www.azleg.gov/arsDetail/?title=49	http://apps.azsos.gov/public_services/Title_18/18-13.pdf	http://www.azdeq.gov/programs/waste-programs/solid-waste-program

Weblinks to Arizona’s Cleanup Standards, EPA’s Region 9 Screening Levels and MCLs:

Media Type	Applicable Arizona Administrative Code	Weblink to applicable Arizona Administrative Code
Soil	Title 18, Chapter 7, Article 2	http://apps.azsos.gov/public_services/Title_18/18-07.pdf
Surface Water	Title 18, Chapter 11, Article 1	http://apps.azsos.gov/public_services/Title_18/18-11.pdf
Reclaimed Water	Title 18, Chapter 11, Article 3	http://apps.azsos.gov/public_services/Title_18/18-11.pdf
Groundwater	Title 18, Chapter 11, Article 4	http://apps.azsos.gov/public_services/Title_18/18-11.pdf
	EPA’s MCLs	http://water.epa.gov/drink/contaminants/
Soil, Vapor, and Groundwater	EPA Region 9 Regional Screening Levels	http://epa.gov/region9/superfund/prg/
Soil – Groundwater Protection Level (GPL)	Title 18, Chapter 7, Article 2 (R18-7-203(B)(3))	http://apps.azsos.gov/public_services/Title_18/18-07.pdf
Link to GPL model		Instructions; spreadsheet

Section 2.0 Program Summaries, Statutes and Administrative Code

The Waste Programs Division (WPD) of ADEQ administers several different environmental programs, notably the Voluntary Remediation Program (VRP), Underground Storage Tanks (UST), Comprehensive Environmental Response Compensation and Liability Act (CERCLA), Water Quality Assurance Revolving Fund, Hazardous Waste and Solid Waste. Table 2.1 provides a list of these programs plus weblinks to program specific Arizona Revised Statutes (A.R.S.) and Arizona Administrative Code (A.A.C.) and other information.

2.1 Voluntary Remediation Program (VRP)

Through ADEQ's [VRP](#), property owners, prospective purchasers and other interested parties investigate or clean up a contaminated site in cooperation with ADEQ. VRP results in a streamlined process for program participants who work with a single point of contact at ADEQ to address applicable cross-program remediation efforts. ADEQ reviews these voluntary remedial actions and provides a closure document for successful site remediation that is accepted by all relevant ADEQ programs.



The benefits for the volunteer conducting investigations and cleanups through the VRP are as follows:

1. Faster cleanup of environmental contamination;
2. Streamlined processing and interaction with ADEQ;
3. Expedited review and approval of cleanup activities; and
4. No further action determinations for successfully remediated properties.



2.1.1 Statutes, Administrative Code and Submittals

The statutes governing the VRP are located in A.R.S. Title 49, Chapter 1, Article 5 (A.R.S. 49-171 through 49-188). ADEQ adopted rules to implement the statutes. These rules are listed in A.A.C. Title 18, Chapter 7, Article 5 (A.A.C. R18-7-501 through 507). Table 2.1 provides weblinks to these statutes and rules.

Workplan submittals for investigation are required at sites accepted into the VRP. Workplans outline the work to be accomplished at the site and set reporting deadlines (e.g. for progress reports or a characterization report). ADEQ has the regulatory authority to review and approve, request modifications, or deny a workplan.

2.2 Underground Storage Tanks (UST) Program

The [UST Program](#) protects public health and the environment through oversight, investigation and cleanup of soil and groundwater contamination caused by releases from USTs. Owners and operators of leaking USTs (LUSTs) are required to investigate and remediate their releases into the environment.

Complying with the rules in the A.A.C. would result in a streamlined process for program participants.



**Underground Storage Tank removal
J.J.'s Trading Post, Holbrook, AZ**

2.2.1 Statutes, Administrative Code and Submittals

The statutes governing the UST Program are located in A.R.S. Title 49, Chapter 6, Articles 1 through 6 (A.R.S. 49-1001 through 49-1093). ADEQ adopted rules to implement the statutes. These rules are listed in A.A.C. Title 18, Chapter 12, Articles 1 through 9 (A.A.C. R18-12-101 through 903). Table 2.1 provides weblinks to these statutes and rules.

A.A.C. Title 18, Chapter 12, Articles 1 and 2 contains the rules for release reporting and all applicable corrective actions reporting requirements. A.A.C. R18-12-261(D) lists the information required to be submitted in an initial site characterization (90-day) report. A.A.C. R18-12-262(D) lists the information required to be submitted in a LUST site characterization report. ADEQ has the authority to review and determine if the report meets all statutory and administrative requirements.

2.3 Water Quality Assurance Revolving Fund, CERCLA and DoD Programs

ADEQ's [Remedial Projects Section](#) identifies, assesses and cleans up soil, groundwater and surface water contaminated with hazardous substances. The program conducts these efforts throughout Arizona with using state and federal funds. The program also oversees privately-funded cleanup efforts.

The Remedial Projects Section uses the Arizona Water Quality Assurance Revolving Fund (WQARF), created under the Environmental Quality Act of 1986, to support hazardous substance cleanup efforts in the state. The fund is dependent upon legislative appropriations, cost recovery from responsible parties, corporate income tax and special fees. The program identifies sites that are most in need of cleanup and adds them to the WQARF Registry. Sites on the Registry receive first consideration for distribution of funds.



Some contaminated sites in Arizona are governed and funded under CERCLA (1980), commonly known as Superfund. Sites that pose the greatest potential threat to human health and the environment are put on the National Priorities List (NPL). The NPL is the list of national priorities among the known releases or threatened releases of hazardous substances, pollutants, or contaminants throughout the United States and its territories. It is intended primarily to guide the EPA in determining which sites warrant further investigation. Currently, there are nine NPL Superfund sites in Arizona, two of which are divided into north and south portions. In addition to the NPL and the WQARF Registry sites, the Remedial Projects Section also provides state review and oversight at over 200 Department of Defense (DoD) sites.

2.3.1 Statutes, Administrative Code and Submittals

The statutes governing the WQARF Programs are located in A.R.S. Title 49, Chapter 2, Article 5 (A.R.S. 49-281 through 49-298). ADEQ adopted rules to implement the statutes. These rules are listed in A.A.C. Title 18, Chapter 16, Articles 2 through 5 (A.A.C. R18-16-201 through 505). Article 2 contains the rules for preliminary investigations and site scoring. Article 4 contains the rules for topics related to remedy selection such as, community involvement, early response actions, remedial investigations and records of decision. A.A.C. R18-16-406 and A.A.C. R18-16-413 lists the information required to be submitted during a remedial investigation. ADEQ has the authority to review, approve, or deny remedial investigation reports. Table 2.1 provides weblinks to these statutes and rules.

Federal regulations for sites that are governed and funded by the federal CERCLA, such as the NPL and DoD sites, are found at the following websites:

CERCLA:

<https://www.epa.gov/superfund/superfund-cercla-overview>

Superfund Amendments Reauthorization Act (SARA):

<https://www.epa.gov/superfund/superfund-amendments-and-reauthorization-act-sara>

2.4 Hazardous Waste Program

The [ADEQ Hazardous Waste Program](#) administers [Resources Conservation and Recovery Act \(RCRA\) Subtitle C](#) requirements for hazardous waste through Arizona's Revised Statutes and Administrative Code. The Subtitle C regulations establish a system for controlling hazardous waste from the time it is generated until its ultimate disposal — in effect, from “cradle to grave.” To this end, there are Subtitle C regulations for the generation; transportation; and treatment, storage or disposal of hazardous wastes. In practical terms, this means regulating a large number of hazardous waste handlers. In administering RCRA Subtitle C, the Hazardous Waste Program also:

- Conducts [compliance and complaint inspections](#) to ensure that hazardous wastes are safely managed and properly recycled;
- Permits facilities that treat, store or dispose of hazardous waste;
- Performs [education and outreach](#) for facilities and general public;
- Manages [ADEQ's pollution prevention \(P2\) program](#) and other activities aimed at eliminating or reducing the use of toxic substances and the generation of hazardous wastes;
- Tracks manifests and annual reports and issuing facility identification numbers.

Past and present activities at *RCRA facilities sometimes result in the need for corrective action which may include site investigation. Additionally, when facilities close, site investigations may be required to determine whether releases have occurred. The requirement for corrective action is a result of the [1984 Hazardous and Solid Waste Amendments](#) (HSWA) passed by Congress. These amendments require the cleanup of contamination due to improper waste management practices both prior and after the passage of RCRA. These amendments require responsible parties that are seeking a permit to treat, store or dispose of hazardous wastes to clean up environmental contaminants at their sites regardless of the time of release. CFR Title 40, 264, Subpart F - [Releases From Solid Waste Management Units](#) is of particular interest to site investigations as they relate to groundwater assessment.

** RCRA focuses only on active and future facilities and does not address abandoned or historical sites which are managed under the Comprehensive Environmental Response, Compensation, and Liability Act ([CERCLA](#)) or the WQARF program see section 2.3).*

2.4.1 Statutes and Administrative Code

The RCRA Subtitle C program has resulted in comprehensive regulations. Much of the Code of Federal Regulations (CFR) Title 40, Parts 260-299 have been adopted as ADEQ regulations. The Arizona statutes governing the Hazardous Waste Program is located in A.R.S. Title 49, Chapter 5 (Articles 1 – 5). ADEQ adopted rules to implement the statutes. These rules are listed in A.A.C. Title 18, Chapter 8, Articles 1 and 2. Table 1.1 provides weblinks to the location of the Arizona’s Revised Statutes and Administrative Code governing the program.

2.5 Solid Waste Program

The [ADEQ Solid Waste Program](#) administers [RCRA Subtitle D](#) requirements for solid waste through the A.R.S. and A.A.C. The RCRA Subtitle D requirements focus on the management of non-hazardous solid waste, such as household garbage and non-hazardous industrial solid waste. To assist the regulated community in making better decisions in dealing with waste issues, ADEQ’s Solid Waste Program provides businesses and municipalities with information, guidance, and regulations through workshops and publications.

RCRA Subtitle D, along with Arizona’s statutes and codes, also establishes requirements that include permitting, monitoring and closure of municipal solid waste facilities. ADEQ has regulations for the proper design and operation of municipal solid waste landfills (MSWLFs) and other solid waste disposal facilities. The design and operations includes groundwater monitoring requirements. Site investigations may involve investigating background soil concentrations. [CFR Title 40, §§ 257.21 through 28](#) and [CFR Title 40, §§ 258.50 through 58](#) are of particular interest to site investigations as they relate to groundwater assessment.

2.5.1 Statutes and Administrative Code

The RCRA Subtitle D program has resulted in comprehensive regulations. Much of the CFRs Title 40, Parts 257-258 have been adopted as ADEQ regulations. The Arizona statutes governing the Solid Waste Program are located in A.R.S. Title 49, Chapter 4, (A.R.S. 49-701 through 49-881). ADEQ adopted rules to implement the statutes. These rules are listed in A.A.C. Title 18, Chapter 13, Articles 2, 3, 5, 7, 8, 9, and 11 - 14. Table 2.1 provides weblinks to the location of the Arizona’s Revised Statutes and Administrative Code governing the program.

Table 2.1 - Program Weblinks

Program Name	Weblink to Programmatic Arizona Revised Statutes	Weblink to Programmatic Arizona Administrative Code	ADEQ website program information link
Voluntary Remediation Program	http://www.azleg.gov/arsDetail/?title=49	http://apps.azsos.gov/public_services/Title_18/18-07.pdf	http://www.azdeq.gov/programs/vrp
UST Program	http://www.azleg.gov/arsDetail/?title=49	http://apps.azsos.gov/public_services/Title_18/18-12.pdf	http://www.azdeq.gov/UST
WQARF and CERCLA Programs	http://www.azleg.gov/arsDetail/?title=49	http://www.azdeq.gov/programs/waste/WQARF	http://www.azdeq.gov/environ/waste/sps/index.html
Hazardous Waste Program	http://www.azleg.gov/arsDetail/?title=49	http://apps.azsos.gov/public_services/Title_18/18-08.pdf	http://www.azdeq.gov/programs/waste-programs/hazardous-waste-management
Solid Waste Program	http://www.azleg.gov/arsDetail/?title=49	http://apps.azsos.gov/public_services/Title_18/18-13.pdf	http://www.azdeq.gov/programs/waste-programs/solid-waste-program

2.6 Cleanup Standards and EPA Region 9 Screening Levels

In accordance with [A.R.S. § 49-221\(C\)](#), water quality standards are set considering, but not limited to, the following:

1. The protection of the public health and the environment;
2. The uses which have been made, are being made or with reasonable probability may be made of these waters;
3. The provisions and requirements of the [clean water act](#) and [safe drinking water act](#) and the regulations adopted pursuant to those acts;
4. The degree to which standards for one category of waters could cause violations of standards for other, hydrologically connected, water categories;
5. Guidelines, action levels or numerical criteria adopted or recommended by the United States environmental protection agency or any other federal agency; and
6. Any unique physical, biological or chemical properties of the waters.

Please note that if there is no established Aquifer Water Quality Standard for a contaminant, MCLs may apply. MCLs are national water standards set by the EPA. Please see Section 1.3 of this document and the following hyperlink for a discussion on [primary drinking water standards and MCLs](#).

Soil remediation standards were established in accordance with [A.R.S. § 49-152](#). There are pre-determined residential and non-residential standards based on exposure

assumptions. The standards also provide guidance on calculating case-by-case, site specific risk based remediation levels in accordance with risk assessment methodologies that are accepted in the scientific community and do not preclude the use of newly developed risk assessment methodologies that are accepted in the scientific community. Further explanation of the soil remediation standards can be found at the Arizona Administrative Register (A.A.R.) – [13 A.A.R. 971](#).

Descriptions and listings of the clean-up standards for soils, surface water, reclaimed water and groundwater are outlined in Table 2.2 below.

Table 2.2 - Weblinks to Arizona’s Cleanup Standards, EPA Region 9 Screening Levels and MCLs

Media Type	Applicable Arizona Administrative Code	Weblink to applicable Arizona Administrative Code
Soil	Title 18, Chapter 7, Article 2	http://apps.azsos.gov/public_services/Title_18/18-07.pdf
Surface Water	Title 18, Chapter 11, Article 1	http://apps.azsos.gov/public_services/Title_18/18-11.pdf
Reclaimed Water	Title 18, Chapter 11, Article 3	http://apps.azsos.gov/public_services/Title_18/18-11.pdf
Groundwater	Title 18, Chapter 11, Article 4	http://apps.azsos.gov/public_services/Title_18/18-11.pdf
	EPA’s MCL’s	http://water.epa.gov/drink/contaminants/
Soil, Vapor, and Groundwater	EPA Region 9 Regional Screening Levels	http://epa.gov/region9/superfund/prg/
Soil – Groundwater Protection Level (GPL)	Title 18, Chapter 7, Article 2 (R18-7-203(B)(3))	http://apps.azsos.gov/public_services/Title_18/18-07.pdf
Link to GPL model		Instructions ; spreadsheet

2.6.1 Narrative Aquifer Water Quality Standards

Many contaminants of concerns (COCs) do not have an established numeric Aquifer Water Quality Standard (AWQS). For the purpose of assessing a violation, the COCs that do not have an established numeric AWQS are regulated under the Narrative Aquifer Water Quality Standards (A.A.C. R18-11-405) which states:

- A. A discharge shall not cause a pollutant to be present in an aquifer classified for a drinking water protected use in a concentration which endangers human health.

- B. A discharge shall not cause or contribute to a violation of a water quality standard established for a navigable water of the state.
- C. A discharge shall not cause a pollutant to be present in an aquifer which impairs existing or reasonably foreseeable uses of water in an aquifer.

All COCs, with or without an established AWQS, need to be considered during all stages of investigative and remedial actions. Please note that the Arizona Department of Health Services can assist in evaluating and calculating cleanup standards. Also, please see [A.R.S. § 49-282\(E\)\(15\)](#).

2.6.2 Regional Screening Levels

Regional Screening Levels (RSLs) are developed by EPA and are developed using risk assessment guidance from the EPA Superfund program and can be used for Superfund sites and ADEQ programs, as appropriate. They are risk-based concentrations derived from standardized equations combining exposure information assumptions with EPA toxicity data. RSLs are considered by EPA to be protective for humans (including sensitive groups) over a lifetime; however, RSLs are not always applicable to a particular site and do not address non-human health endpoints, such as ecological impacts. The RSLs contained in the RSL table are generic; they are calculated without site-specific information. They may be re-calculated using site-specific data.

EPA uses these RSLs for site "screening" and as initial cleanup goals, if applicable. RSLs are not de facto cleanup standards and should not be applied as such. The RSL's role in site "screening" is to help identify areas, contaminants, and conditions that require further federal attention at a particular site. Generally, at sites where contaminant concentrations fall below RSLs, no further action or study is warranted under the Superfund program, so long as the exposure assumptions at a site match those taken into account by the RSL calculations. Chemical concentrations above the RSL would not automatically designate a site as "dirty" or trigger a response action; however, exceeding a RSL suggests that further evaluation of the potential risks by site contaminants is appropriate. RSLs are also useful tools for identifying initial cleanup goals at a site. In this role, RSLs provide long-term targets to use during the analysis of different remedial alternatives. By developing screening levels early in the decision-making process, design staff may be able to streamline the consideration of remedial alternatives.

How do RSLs differ from cleanup standards?:

RSLs are generic screening values, not de facto cleanup standards. Once a Baseline Risk Assessment (BLRA) is completed, site-specific risk-based remediation goals can be derived using the BLRA results.

Important Information You Should Know after Reading Section 3.0 – The Conceptual Site Model (CSM):

1. [The meaning of CSM and how it is utilized.](#)
2. [The types of information to be collected for an effective CSM.](#)
3. [Different types of CSM formats.](#)
4. [Typical Evolution of the CSM.](#)

<p>The Meaning of Conceptual Site Model:</p> <p>Conceptual Site Model means a description of the complete current and potential exposure pathways, based on existing and reasonably anticipated future use. More definitively, the CSM describes:</p> <ol style="list-style-type: none"> 1. Sources of contamination known or suspected to be present at a site; 2. Complete, potentially complete, or incomplete exposure pathways; 3. Current, determined, or reasonably anticipated future use of property; and 4. Potential receptors. 	<p>The utilization of a CSM:</p> <p>The CSM is the principal site management and decision making tool that is continually updated throughout the life of an investigation. The CSM is:</p> <ol style="list-style-type: none"> 1. The foundation for making site investigation decisions, evaluating risk to receptors, designing corrective actions, and assessing remedial performance; 2. A tool to utilize for identifying data gaps; and 3. A communication tool for team members 	<p>Typical Information to be Collected for a CSM:</p> <ol style="list-style-type: none"> (1) Facility Profile - describes man-made features and potential sources at or near the site. (2) Physical profile – describes natural factors that may affect release fate and transport, or access. (3) Release Profiles – describes the movement and extent of contaminants in the environment; (4) Land Use and Exposure Profile – provides information used to identify and evaluate applicable exposure scenarios, receptors, and receptor locations. (5) Ecological and Cultural Resources Profile – describes the natural habitats and ecological receptors present on and around the site. 	<p>CSM Formats:</p> <p>There are several types of formats:</p> <p>Narrative, Graphical, Map and Pictorial (2-D and 3-D)</p> <p>A complex site may have several depictions of the CSM, each of which addresses a different medium or subset of the decisions to be made or represents one of multiple hypotheses that need to be clarified by getting more data. Typically, a narrative format is combined with other formats for a site.</p>
---	---	--	---

Typical Evolution of the CSM:

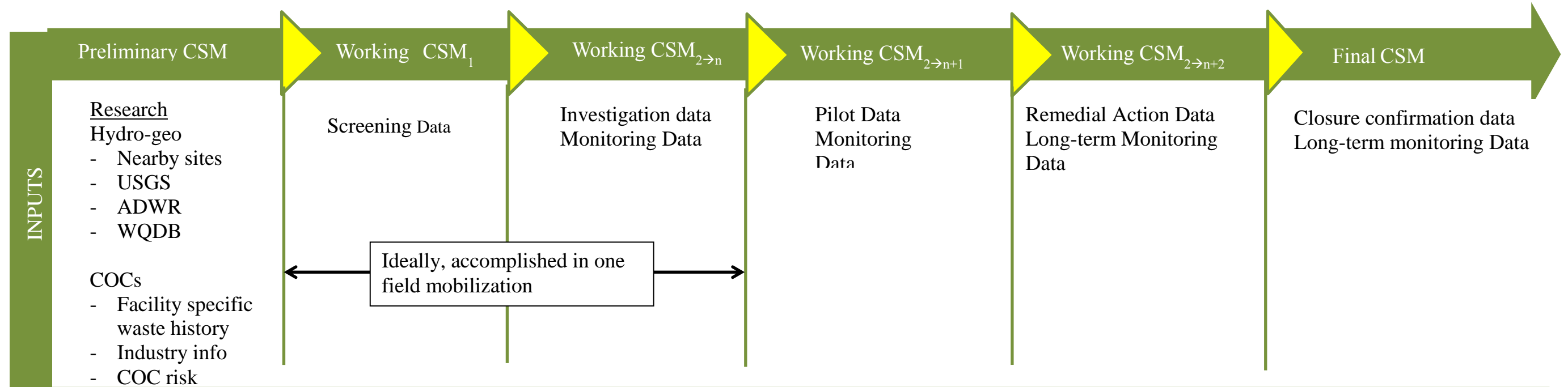

Section 3.0 The Conceptual Site Model (CSM)

“CSM” means a description of the complete current and potential exposure pathways, based on existing and reasonably anticipated future use (A.A.C R18-12-101). A CSM is the principal site management and decision making tool that is continually updated throughout the life of an investigation (see Figure 3.1 Typical Evolution of the Conceptual Site Model).

3.1 What is a CSM

The US Army Corps of Engineers (USACE, 2012) describes a CSM as follows:

“A CSM is a description of a site and its environment, both natural and man-made, that is based on existing knowledge. It describes sources of contamination known or suspected to be present at a site. It also describes complete, potentially complete, or incomplete exposure pathways; current, determined, or reasonably anticipated future use of property; and potential receptors. The CSM serves as a planning instrument, a modeling and data interpretation aid, and a communication device for the team. The CSM can be viewed as a tool to assist the team in communicating with the public, integrating information and making informed decisions. These decisions can range from sampling strategies to cleanup actions. A CSM provides a structure to summarize and display information about a site and identify additional information needed to develop technically sound decisions.”

The New Jersey Department of Environmental Protection (NJDEP, 2011) describes a CSM as follows:

“The goal of a CSM is to provide a description of relevant site features and the surface and subsurface conditions to understand the extent of identified contaminants of concern and the risk they pose to receptors. The CSM is an iterative tool that should be developed and refined as information is obtained during review of the site history and continues throughout the site and/or remedial investigation. The level of detail of the CSM should match the complexity of the site and available data. Development and refinement of the CSM will help identify investigative data gaps in the characterization process and can ultimately support remedial decision making.”

Both the USACE and NJDEP descriptions emphasize the importance of a CSM that is continually updated throughout the site characterization and remedial phases at a site. The emphasis on the use of the CSM is similar in Arizona. For environmental investigations in Arizona, the CSM should be utilized as: 1) the foundation for making site investigation decisions, evaluating risk to receptors, designing corrective actions, and assessing remedial performance; 2) a tool to utilize for identifying data gaps; and 3) a communication tool for team members.

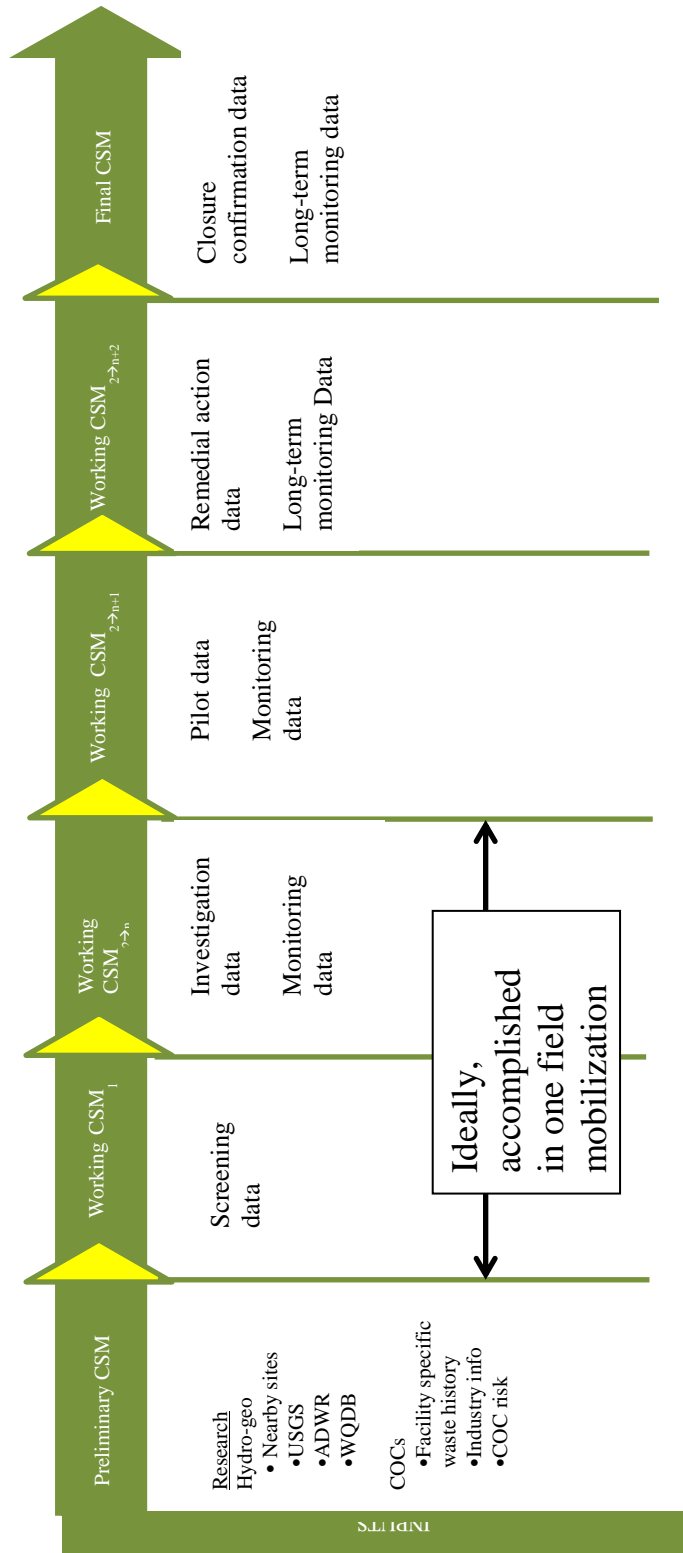

Figure 3.1 – Typical Evolution of the Conceptual Site Model.

CSM development begins during initial investigations (e.g., preliminary assessment) and is then refined as data gaps are filled during subsequent phases. Potential source areas, receptors and media of concern should be documented in the initial CSM. Later versions of the CSM may be used to evaluate the effectiveness of sampling, help focus characterization efforts, record results of any early remedial response actions and during implementation of long-term management actions. The CSM can help focus general regulatory objectives to more site-specific project objectives. Data collection should be focused on complete or potentially complete exposure pathways that are based on current, determined, or reasonably anticipated future land use.

3.1.1 Categories, Elements and Checklists

There are several schemes for categorizing information to be collected for an effective CSM. The USACE (2012) categorizes the needed information into five “profile types” that address specific, yet overlapping types of information. These include:

- (1) Facility Profile - describes man-made features and potential sources at or near the site.
- (2) Physical profile – describes natural factors that may affect release fate and transport, or access.
- (3) Release Profiles – describes the movement and extent of contaminants in the environment;
- (4) Land Use and Exposure Profile – provides information used to identify and evaluate applicable exposure scenarios, receptors, and receptor locations.
- (5) Ecological and Cultural Resources Profile – describes the natural habitats and ecological receptors present on and around the site.

Interstate Technical Regulatory Council (ITRC) (2003) categorizes the key elements to be included in a CSM as follows;

- (1) General physical site description
- (2) Regional environmental setting
 - Geology
 - Hydrogeology
 - Habitat description
- (3) Land use description (property and surrounding properties)
 - Current land use
 - Proposed land use
 - Land use history
- (4) Contaminant regime and site investigations
 - Results of previous site investigations
 - Contaminants of concern
 - Contaminant sources
 - Contaminant fate and transport

October 2014 ADEQ Waste Programs Division
Site Investigation Guidance Manual

- Contaminant susceptibility to various treatment or destruction options
- Contaminant variability in time and space (at larger and smaller scales)
- (5) Potential risks and potential receptors
 - Exposure pathways
 - Activities and risks
- (6) Data Evaluation
- (7) Identification of data gaps and data needs to serve various exposure or remedial decisions

Typical information needs for an effective CSM are similar in any scheme. All available site information and publications collected should be evaluated and summarized in developing a CSM. Below are some of the information needs for each Profile Type that the USACE outlined in their December 2012 Conceptual Site Models Engineering Manual:

- (1) Facility Profile
 - All structures, sewer systems, process lines, underground utilities
 - Physical boundaries (past and current), fencing, administrative controls, etc.
 - Current and historical process and manufacturing areas
 - Operation procedures and history
 - Storage and waste disposal
 - Historical features that indicate potential source areas
- (2) Physical Profile
 - Topographic and vegetative features and other natural barriers
 - Surface water features and drainage pathways
 - Surface and subsurface geology, including soil type and properties
 - Meteorological data
 - Geophysical data
 - Hydrogeological data for depth to groundwater and aquifer characteristics
 - Physical site factors that affect site activities
 - Soil boring or monitoring well logs and locations
 - Development, construction (e.g. grading)
- (3) Release profile
 - Determination of contaminant movement from source areas
 - Contaminants and media of potential concern, including chemical properties (e.g. solubility, volatility, etc.) of any environmental contaminant
 - Impact of chemical mixtures and co-located waste on transport mechanisms
 - Locations and delineation of confirmed releases with sampling locations
 - Migration routes and mechanisms
 - Modeling results
- (4) Land use and Exposure Profile

October 2014 ADEQ Waste Programs Division
Site Investigation Guidance Manual

- Receptors with current, determined or reasonably anticipated future land use (e.g., residential, recreational, commercial, agricultural, industrial, public forest) on or near the facility)
 - Types of current or future activities at the facility, including frequency and nature of activity (intrusive or non-intrusive)
 - Zoning, Master planning, community interests, and any government restrictions such as safety fly zones or noise zone near airports
 - Beneficial resource determination (aquifer classification, natural resources, wetlands, cultural resources, etc.)
 - Resource use locations (e.g. water supply wells, recreational swimming, boating, or fishing areas, hiking trails, grazing lands, burial grounds)
 - Demographics, including subpopulation types and locations (e.g. schools, hospitals, day care centers, site workers)
- (5) Ecological and Cultural Resource Profile
- Description of the environment at the facility, including habitat type (wetland, forest, desert, pond, etc.), quantity and quality
 - Primary use of the area and degree of disturbance, if any
 - Identification of any ecological receptors in relation to habitat type (endangered or threatened species, migratory animals, fish, etc.)
 - Relationship of any releases to potential habitat areas (locations, contaminants or hazards of concern, sampling data, migration pathways, etc.)

ADEQ has developed a recommended CSM checklist. This checklist can be expanded depending upon site conditions. The recommended ADEQ CSM checklist is located in Appendix A.

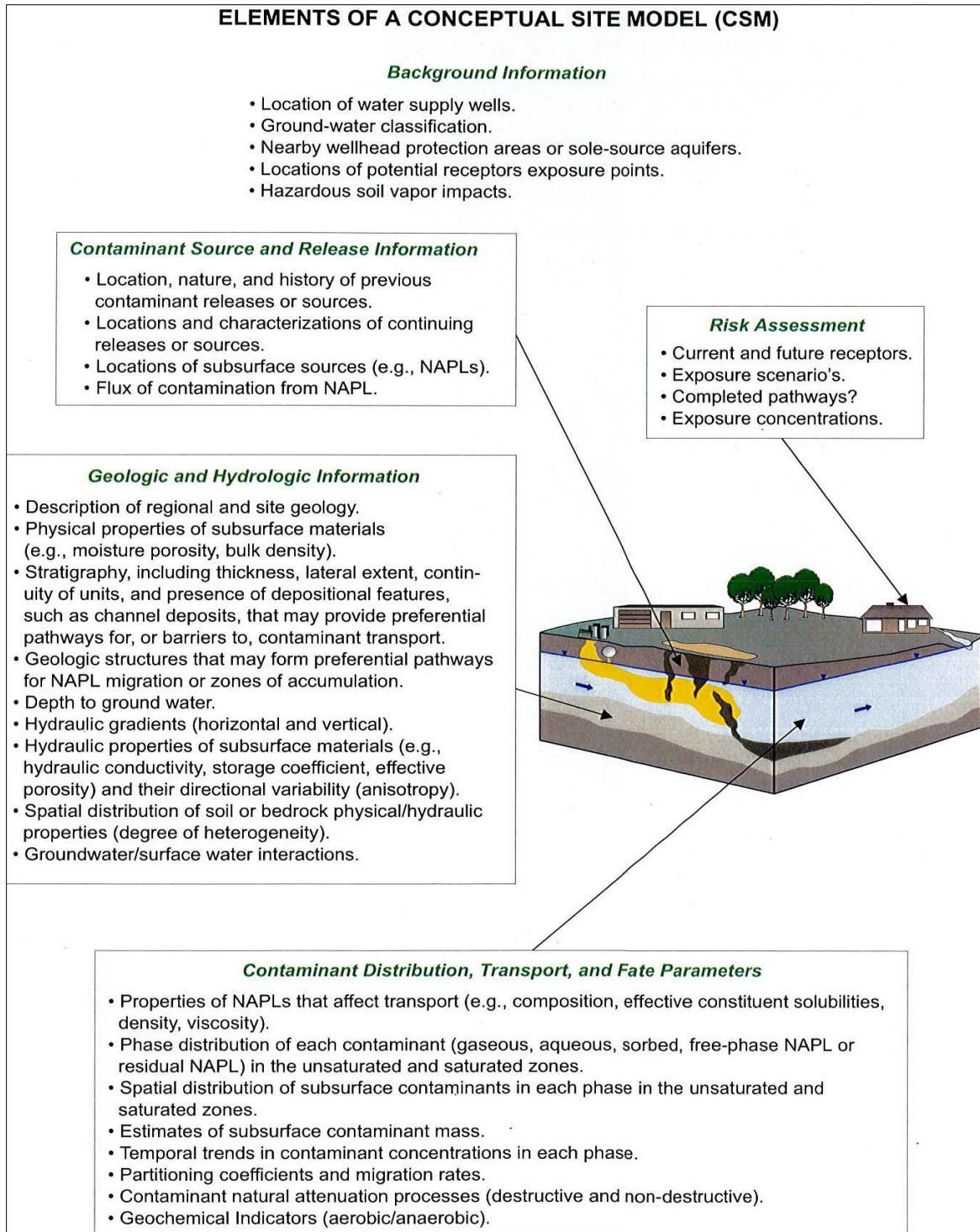

Figure 3.2 Elements of a Conceptual Site Model (modified from EPA, 1993)

Checklists for CSMs can be found in several publications. Figure 3.2 further describes the information needed in a CSM by adding a pictorial to its summary of information needs. Some weblinks that provide example checklists are listed below:

1. US Army Corps of Engineers (December 2012)
http://www.publications.usace.army.mil/Portals/76/Publications/EngineerManuals/EM_200-1-12.pdf
2. January 2011 – NJ CSM checklist and examples: Appendices A through C
http://www.state.nj.us/dep/srp/guidance/srra/csm_tech_guidance.pdf
3. August 2008 - California CSM for Remediation of metals in soils
http://www.dtsc.ca.gov/SiteCleanup/upload/Appdx_A1_083108.pdf
4. Late 80's early 90's – EPA checklist
<http://www.epa.gov/superfund/health/conmedia/soil/pdfs/attacha.pdf>
5. Date and source unknown - checklist
http://www.triadcentral.org/ref/ref/documents/CSM_checklist.pdf

ASTM E1689-95(2008) Standard Guide for Developing Conceptual Site Models for Contaminated Sites also contains a CSM checklist on information needs.

3.1.2 Typical Investigative CSM Related Questions

The following are typical questions an investigator asks when developing a CSM. By no means is this an exhaustive list that identifies all the types of information which could be collected during the investigative process. The questions listed below all relate to the checklists described above.

Source Areas

- (1) Have release locations and mechanisms been identified?
- (2) Has the nature and extent of surface soil and/or vadose zone contamination been characterized?
- (3) Is the transport and fate of surface soil and/or vadose zone contamination understood?
- (4) Are there potential receptors to soil and/or vadose zone contamination?
- (5) Do surface soil and/or vadose zone contamination present a risk through various exposure pathways?
 - Ingestion
 - Inhalation
 - Underlying groundwater
 - Adsorption
- (6) Based on the above, what data gaps exist?
 - What are the potential consequences of not addressing these data gaps?

- (7) Based on the above and any other information, what has or needs to be done to manage risk?

Groundwater Plumes

- (1) Are the sources of groundwater contamination known?
 - o Are there continuing sources?
- (2) Has a well inventory (ADWR records and field inventory) been completed/updated identifying all well locations/types and associated water use in the area?
- (3) Have any potentially impacted drinking water wells been sampled?
- (4) Has the nature and lateral/vertical extent of groundwater contamination been characterized?
- (5) Are there hydrogeologic controls/preferential pathways affecting lateral and/or vertical plume migration?
- (6) Are there hydraulic controls/influences wells affecting lateral and/or vertical plume migration?
- (7) Are there conduit wells affecting vertical plume migration?
- (8) Are natural attenuation processes affecting contaminant transformation and/or migration?
- (9) Are there areas where shallow groundwater and associated high VOC levels could cause lead to vapor intrusion?
- (10) Based on the above, what data gaps exist?
 - o What are the potential consequences of not addressing these data gaps?
- (11) Based on the above, what has or needs to be done to manage risk?

3.1.3 CSM Formats

There are several types of formats for CSMs. The CSM format can be narrative, graphical, map, pictorial, or 3-D pictorial. Figure 3.2 is one example of scheme in developing a CSM. Different decisions may require different CSM formats. For example, decisions about groundwater contamination migration or cleanup need a CSM that emphasizes hydrogeology, contaminant concentrations and fate information; whereas decisions about contaminant exposure require a CSM that focuses on identifying all potential receptors and exposure pathways. A geologic cross section is an effective method to show manmade and natural features that affect contaminant transport and receptor exposure. A complex site may have several depictions of the CSM, each of which addresses a different medium or subset of the decisions to be made or represents one of multiple hypotheses that need to be tested by getting more data. Typically, a narrative format is combined with other formats for a site. Narrative formats are discussed further in Section 3.6 of this document. Appendix D of the US Army Corps of Engineers December 2012 *Conceptual Site Models Engineering Manual* has several examples of different types of formats (ITRC, 2003 and USACE, 2012).

3.2 Development of the Working CSM

The first step in moving the CSM from the preliminary CSM to the working CSM would be to collect screening data needed to begin to define the problem. This may include collecting passive soil vapor data to help identify the potential source area as well as collecting groundwater samples from existing wells.

It is also important to clarify if the CSM is being developed to assess potential/actual impacts to human or ecological receptors or both. The description of the CSM should include a complete site plan depicting the extent of the investigation area addressed by the conceptual site model, a depiction of identified area of concerns/source area, potential COCs, pertinent features affecting contaminant migration, identified potential receptors, and the applicable remediation activities.

The CSM should be continually scrutinized as additional site data becomes available during the course of the project. As shown in figure 3.1, CSM development does not end at site characterization. Pilot, remedial action and closure data offer an excellent opportunity to test the CSM and determine whether the current CSM explains the data. If not, the CSM should be re-examined to determine whether further revisions to the CSM are warranted.

3.2.1 Description of Working CSM Scope – Site-wide or Area of Concern

As the development of the working CSM continues, the scope of the CSM should include establishing the areal extent of the investigation. It should be clear if the CSM will be limited to an area of concern or the entire site, and if it will extend off site to include regional features.

For large sites (e.g., some NPL sites) there may be CSMs that focus on different areas (source areas vs. large downgradient plume). A source area CSM may require much more detail but should be technically consistent (e.g. hydrogeology and contaminant pathways) with the plume area CSM.

3.2.2 Description of the Working CSM - Extent of Investigative Area

The working CSM should include a description of the areal extent of the investigation including: identification of human populations that may be impacted by the contamination (e.g., private or public supply wells); any critical species (such as federally or state threatened or endangered species) that may live on or adjacent to the site; identification of any environmentally sensitive natural resources or critical habitats within the area associated with identified migration pathways. The investigator should present this information in map form and update it as the data is collected for all migration pathways related to the site.

The extent/boundaries of the CSM should be based on other specific projects/infrastructure etc. that could be affected by the contamination and/or could be affecting contaminant transport. This may require extending the area of the CSM to include areas with pumping wells and or recharge facilities (for example) that are affecting transport and/or could be receptors. There should also be a judgment made on the vertical extent – for example the depth of active production wells in the area or conduit wells.

3.2.3 CSM Development Beyond the Initial Investigative Stage

Although this guidance manual does not specifically address activities beyond the investigative stage of a project, it is important to remember that the CSM should be continually scrutinized as additional site data becomes available during the course of the project. For example, pilot tests can be viewed as a tool to further develop the CSM under challenging subsurface conditions. It may be conducted to assist in remedy selection or to facilitate remedial design. It is usually conducted when there is significant uncertainty regarding how the subsurface will respond to potential soil and groundwater remedial technologies such as, for example, groundwater and soil vapor extraction, air sparging, in-situ chemical oxidation and in-situ bioremediation.

A pilot test should be conducted before implementing a soil vapor extraction remedy at most sites to evaluate the potential remedy and further develop the CSM. During the test, soil vapor, for example, is extracted at varying rates from vapor extraction well(s) often screened at specific depth intervals where contamination has been observed. Data regarding the subsurface pressure before and after the test is collected at different locations and the influent concentration is monitored. The pressure data is used to calculate soil air permeability. The effluent concentration data will assist in evaluating the horizontal and vertical location(s) of subsurface contamination and the size of the carbon vessels needed for effluent treatment. Both source location and air permeability are important CSM components. Lastly, the time to peak concentrations can be used with the flow rate data to estimate the distance of the source from the extraction well.

Similarly, an aquifer pilot test should be considered to further develop the CSM if groundwater extraction is going to be considered as part of a remedial strategy. During the aquifer test, groundwater is extracted from a well screened within the contaminant plume while water levels are measured at monitor wells located at varying distance from the extraction well. Effluent concentrations from the extraction well are measured periodically. The aquifer test data will produce estimates of hydraulic conductivity that are essential in estimating contaminant fate and transport.

CSM development is not complete even after the remedy has been implemented. The data collected during remedial activities and long term monitoring should be examined to evaluate whether the CSM is adequate for the site. Two examples are given below:

1. A remedial plan for a site with a groundwater pump and treat system should allow estimates of treatment system effluent concentrations over time and concentration changes in monitor wells. The actual data from the site should be used to test the working CSM and determine whether revisions are necessary.
2. Water level data should be carefully examined to evaluate whether the working CSM assumptions regarding plume capture for a groundwater extraction system are satisfactory.

3.3 A Tool for Decision Making

The CSM will evolve as information is gathered throughout the life of a project. As the understanding of the source, nature and extent of contamination is realized, the information should be used to evaluate fate and transport of the contaminants to the receptors. By periodically evaluating the completeness of the conceptual site model, data gaps can be more readily identified and addressed to ensure there is a complete understanding of contaminant impacts.

By developing the CSM through this iterative process, remedial decisions can be made to effectively address and protect the impacted and/or potentially impacted receptors. Uncertainties associated with the CSM can be clearly identified so that efforts can be taken to reduce these uncertainties to acceptable levels. Early versions of the CSM, which are usually based on limited or incomplete information, will identify the uncertainties that should be addressed. Performance of an assessment of data usability/data representativeness should be completed to ensure identification of data limitations affecting the use of the CSM (see discussion of applying data usability/representativeness concepts to the conceptual site model presented in Sections 2.4.3 and 2.4.4 of the December 2003 ITRC “Technical and Regulatory Guidance for the Triad Approach: A New Paradigm for Environmental Project Management”).

3.4 Identification of Human and Ecological Receptors

The identification of potential receptors is the key function of the conceptual site model and should take place upon the initial discovery of the discharge and continue to be refined as the investigation proceeds. Human and ecological receptors include those that are impacted or threatened by the contaminants of concern, located within the investigative area or present along an identified migration pathway. Future use of the site may affect the exposure scenario; therefore, the CSM should identify, when possible, the future use of the site and take into consideration future exposures to all receptors.

Include the following in the human receptor evaluation:

- (1) contaminant or suite of contaminants that are evaluated;
- (2) pathway of exposure to each contaminant of concern via direct contact (i.e., ingestion, inhalation or dermal contact) or bioaccumulation along food chain; and

- (3) populations that are currently or potentially exposed.

The ecological risk evaluation is often separate from the human risk evaluation since humans are potentially exposed to contamination differently (e.g., migration pathway or food source) than ecological receptors. Generally, the ecological receptor evaluation should address the following components:

- (1) contaminants of potential ecological concern (including co-occurrence of contaminants) for soil, groundwater, surface water and sediment;
- (2) current and future exposed species: representative of major groups present at site, not necessarily all species on or adjacent to site;
- (3) contaminant migration pathways to environmentally sensitive areas; and
- (4) map of exposed population along each migration pathway.

For clarity, the presentation of the ecological and human receptor evaluations should be presented separately within the CSM.

3.5 Narrative Description

The narrative description puts all the pieces of the conceptual site model together in a summary fashion for the site as it is understood at that time. For a simple scenario, the narrative description may be notes or text boxes on a drawing. For a more complex site, it may be the section of a report. It should clearly describe the site, contaminants, pathways, and receptors. It should also include a discussion of data gaps or uncertainties.

3.6 Other reference utilized

1. New Jersey Department of Environmental Protection (NJDEP, 2011) – Technical Guidance for Preparation and Submission of a Conceptual Site Model.

Hyperlink:

http://www.state.nj.us/dep/srp/guidance/srra/csm_tech_guidance.pdf

Important Information You Should Know after Reading Section 4.0 – Exposure Pathways:

1. [The Five Exposure Pathways Elements and examples of each element.](#)
2. [The difference between a complete, potentially complete and incomplete exposure pathway.](#)
3. [How to depict exposure pathways into a conceptual site model.](#)

The five different elements of an exposure pathway are:

- a. [Source](#)
- b. [Environmental Media/Fate and Transport](#)
- c. [Exposure Point](#)
- d. [Exposure Route](#)
- e. [Receptor Population](#)

1) Source (examples):

- Landfill
- Dry Cleaners
- Disposal pits
- Buried Waste
- Tanks
- Waste piles
- Open burn areas
- Fire training areas
- Drums
- Factory

2) Environmental Media/Fate and Transport (examples):

- Soil
- Sediment
- Animals/Plants
- Groundwater
- Surface water
- Air

3) Exposure Point (examples):

- Residence
- Business
- Residential yard
- Playground
- Campground
- Waterway

4) Exposure Route (examples):

- Breathing air that contains the material
- Eating/drinking something with the material in it
- Getting it on your skin or touching something that has the material in it or on it

5) Receptor/Population (examples):

- Residents
- Residential yard
- Visitors
- Business
- Campground
- Waterway

Examples of conceptual site models depicting Exposure Pathways:

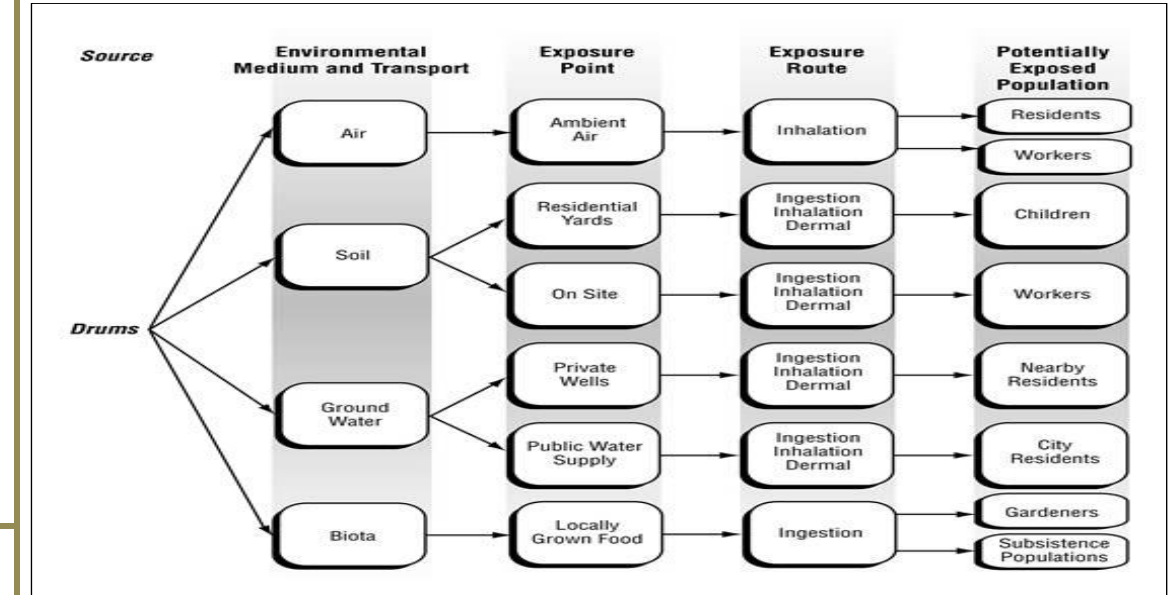

The difference between a complete, potentially complete and incomplete exposure pathway are:

- a. A complete exposure pathway has all the elements present (i.e. the receptor is being exposed to contaminants from the source)
- b. A potentially complete exposure pathway may have all the elements present (i.e. more data is needed prior to concluding whether or not a receptor is being exposed to contaminants from the source)
- c. An incomplete exposure pathway has one or more elements missing (i.e. the receptor is not being exposed to contaminants from the source)

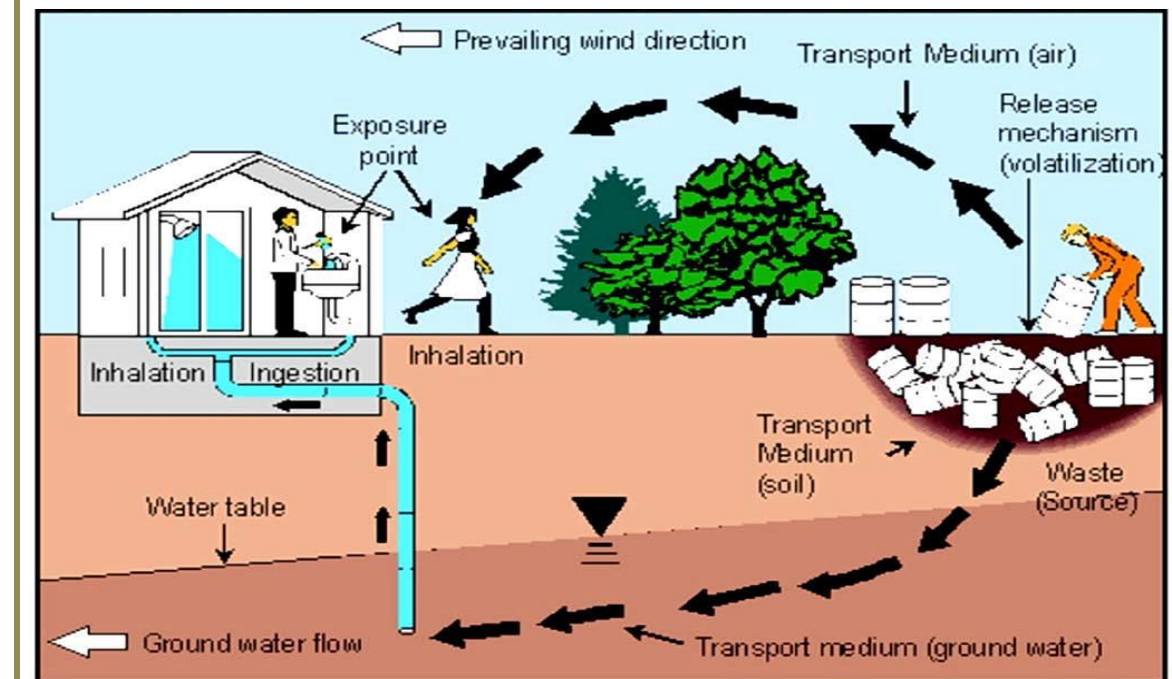
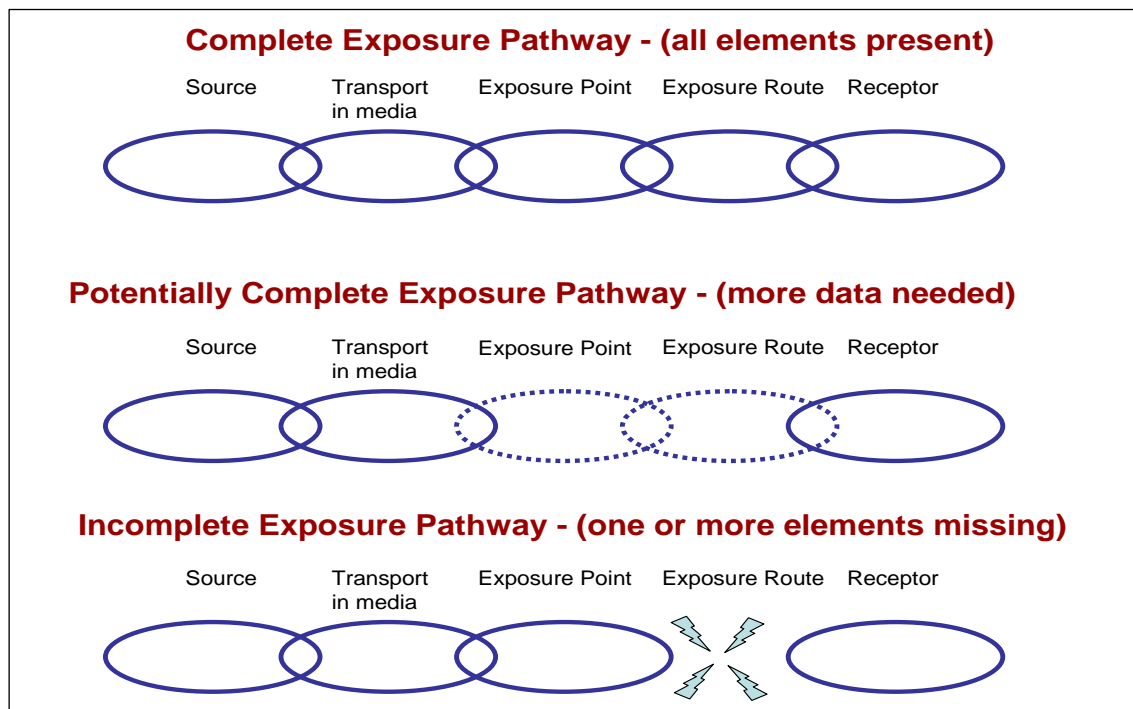

Section 4.0 Exposure Pathways

A.A.C. R18-7-201 defines exposure, exposure pathway, exposure point and exposure route in the following ways:

- 1) Exposure means contact between contaminants and organisms;
- 2) Exposure pathway means the course a contaminant takes from a source to an exposed organism. Each exposure pathway includes a source or release from a source, an exposure point, and an exposure route. If the exposure point differs from the source, transport/exposure media (that is, air, water) are also included.
- 3) Exposure point means a location of potential contact between a contaminant and an organism.
- 4) Exposure route means the way a contaminant comes into contact with an organism (that is, ingestion, inhalation, or dermal contact).

Exposure pathway is the term that encompasses the other terms defined above. There are five (5) elements to an exposure pathway. These elements are listed below:

- 1) Source – How the material gets in the environment.
- 2) Environmental Media/Fate and Transport – How contaminants move through soil, water, or air, and are transformed in the environment.
- 3) Exposure Point – a location of potential contact between a contaminant and an organism.
- 4) Exposure Route – The way a contaminant comes into contact with an organism (ingestion, inhalation, or dermal contact).
- 5) Receptor/Population – Organisms that are exposed or potentially exposed.

A critical early step in the investigation process is evaluating exposure pathways. The goal of exposure pathway evaluations is to identify likely site-specific exposure situations and answer the questions: Are any human or ecological receptors at a given site exposed to environmental contamination? Under what conditions does this exposure occur (ATSDR, 2005)? The answers to these questions should be developed early on in the site's CSM development.

4.1 Complete, Potentially Complete and Incomplete Exposure Pathways

Figure 4.1 is a conceptual illustration of complete, potentially complete and incomplete pathways. An exposure pathway is considered complete when all five elements of an exposure pathway are present. A completed exposure pathway connects the source of the contaminant to the receptor(s). If there is not enough information on one or more of the element of an exposure pathway, it is considered a potentially complete exposure

pathway until the needed information is gathered and incorporated into the CSM. If one of the elements is missing from the exposure pathway, it is considered to be incomplete. If the exposure pathway is incomplete, there is no exposure to receptors.

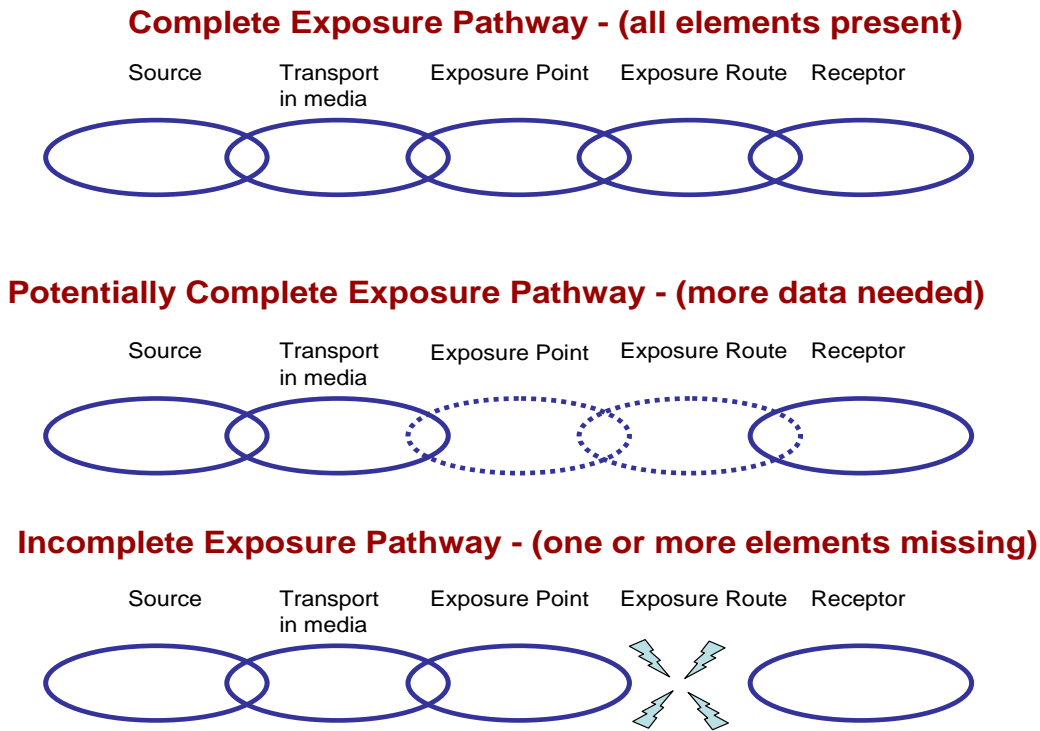

Figure 4.1 Exposure Pathway Category Illustration

4.2 Exposure Pathway Elements

Examples of each element of an exposure pathway are given in Table 4.1 and are also depicted in an organizational chart (Figure 4.2) and an illustration (Figure 4.3).

Table 4.1 Exposure Pathway Element Examples

<p>1) Source:</p> <ul style="list-style-type: none"> • Landfill • Incinerator • Disposal pits • Buried Waste • Tanks • Waste piles • Open burn areas • Fire training areas • Drums • Factory 	<p>2) Environmental Media/Fate and Transport:</p> <ul style="list-style-type: none"> • Soil • Sediment • Animals/Plants • Groundwater • Surface water • Air
<p>3) Exposure Point:</p> <ul style="list-style-type: none"> • Residence • Business • Residential yard • Playground • Campground • Waterway 	<p>4) Exposure Route:</p> <ul style="list-style-type: none"> • Breathing air that contains the material • Eating/drinking something with the material in it • Getting it on your skin or touching something that has the material in it or on it
<p>5) Receptor/Population:</p> <ul style="list-style-type: none"> • Residents • Residential yard • Visitors • Waterway • Business • Campground 	

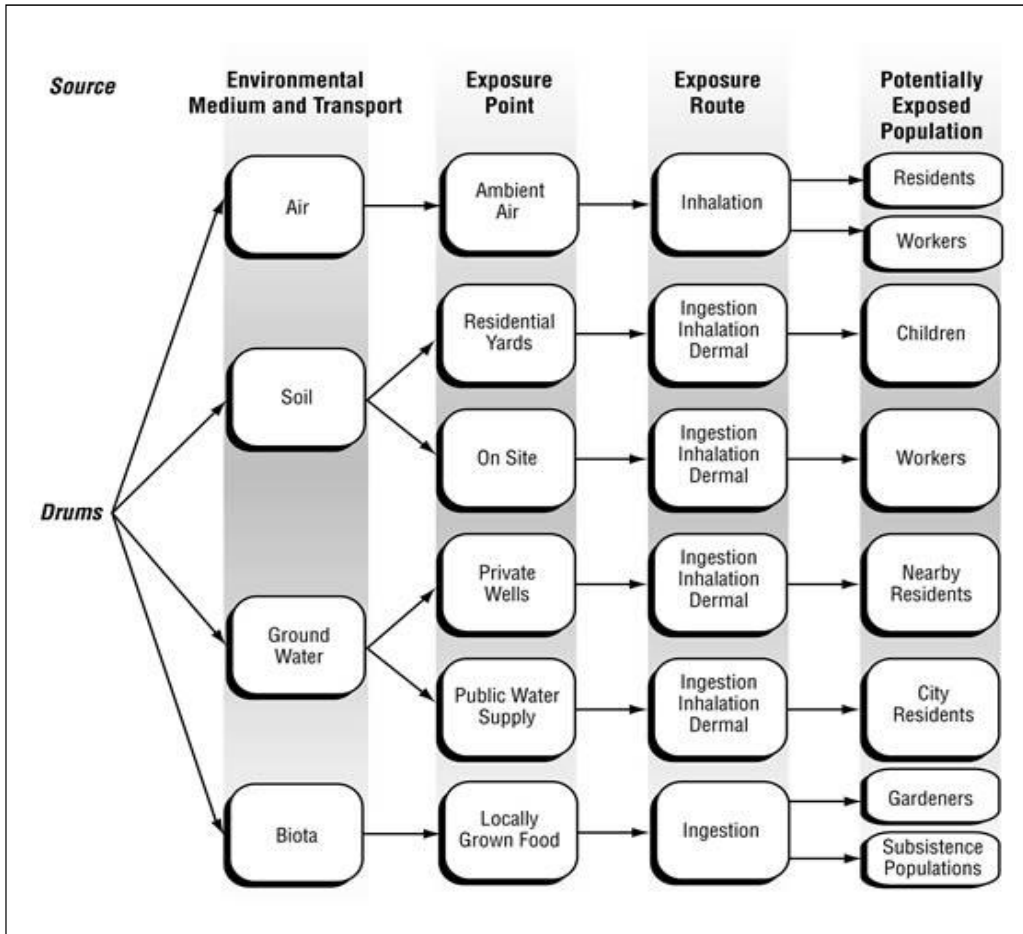

Figure 4.2 Conceptual Site Model – Exposure Pathway Evaluation (ATSDR, 2005)

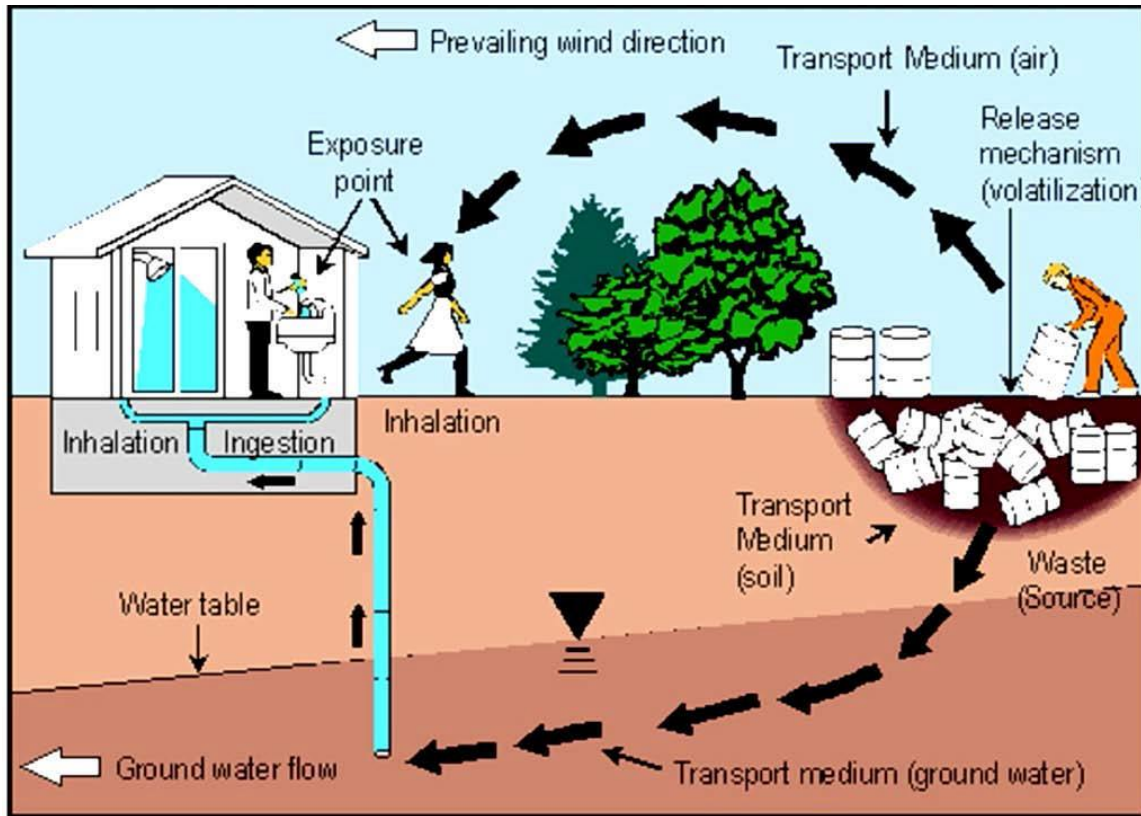

Figure 4.3 Conceptual Site Model – Exposure Pathway Illustration

4.2.1 Contamination sources (The first element of an exposure pathway)

ATSDR (2005) indicates that a contamination source is the origin of environmental contamination. Identifying possible contamination sources helps determine which environmental media may be affected and how hazardous substances might reach populations at or near a site.

A site may have one or more contamination sources. Each source represents a location – a point or area – where a release of contaminants may be occurring or may have occurred. Knowledge of a site’s sources is critical because it enables the investigator to determine whether all possible receiving media have been adequately studied. For example, if the source of contamination is a leaking underground storage tank, reviewing levels of contamination in soil, soil vapor, and groundwater will be necessary to accurately determine if receptors are being exposed.

Sometimes, elevated contaminant levels may be found at a site, but the original source of contamination may not be readily identifiable. For example, elevated levels of lead (compared to background) may be detected in site soils but the source of the lead contamination might not be identifiable. In such cases, one might conclude that a source of contamination existed at some point in the site's history, though the details of the original release might not be known. In other cases, the source of detected contamination may be upgradient of the site (ATSDR, 2005).

4.2.2 Environmental Media/Fate and Transport (The second element of an exposure pathway)

Fate and transport refers to how contaminants move through, and are transformed in, the environment. They are interdependent processes. *Transport* involves the movement of gases, liquids, dissolved constituents and particulate solids within a given medium and across interfaces between water, soil, sediment, air, plants, and animals. *Fate* refers to what eventually happens to contaminants released to the environment - some fraction of the contaminants might simply move from one location to the next; other fractions might be physically, biologically, or chemically transformed; and others still might accumulate in one or more media. Basic understanding of fate and transport mechanisms assists in evaluating past, current and possible future exposures. Please note that fate and transport evaluation is generally a qualitative exercise and often does not require quantitative evaluations (i.e., modeling studies).

Some questions that a fate and transport evaluation may be required to answer are: What is the likelihood of contamination migrating from a surficial aquifer to a deeper aquifer that serves as a drinking water source? What is the direction and path of a particular groundwater plume? What is the potential for soil or sediment contaminants to accumulate in plants, animals, or fish? What is the likelihood of a groundwater contaminant volatilizing and migrating via soil gas into indoor air?

Different types of information can be utilized when evaluating fate and transport. The following categories of information may be useful for some site-specific evaluations:

- Transport processes that carry a substance away from its source;
- Physical, chemical, and biologic factors that influence the persistence and movement of a substance within and across environmental media; and
- Site-specific environmental conditions, such as climate and topography, that affect how contaminants move through the environment at a given location.

Table 4.2 lists chemical and site specific factors that can affect contaminant transport. (ATSDR, 2005)

Table 4.2 Chemical and Site Specific Factors That May Affect Contaminant Transport (modified from ATSDR, 2005)

Transport Mechanism	Factors Affecting Transport	
	Chemical-specific considerations	Site-specific considerations
Groundwater		
Movement within and across aquifers and to surface water	<ul style="list-style-type: none"> • Density (more or less dense than water) • Water solubility • K_{OC} (organic carbon partition coefficient) • Oxidation state (metals)* 	<ul style="list-style-type: none"> • Site hydrogeology • Precipitation • Infiltration rate • Porosity • Hydraulic conductivity • Groundwater flow direction • Depth to aquifer • Groundwater/surface water recharge and discharge zones • Presence of other compounds • Soil type • Geochemistry of site soils and aquifers • Presence and condition of wells (well location, depth, and use; casing material and construction; pumping rate) • Conduits, sewers
Volatilization (to soil gas, ambient air, and indoor air)	<ul style="list-style-type: none"> • Water solubility • Vapor pressure • Henry's Law Constant • Diffusivity 	<ul style="list-style-type: none"> • Depth to water table • Soil type and cover • Climatologic conditions • Contaminant concentrations • Properties of buildings • Porosity and permeability of soils and shallow geologic materials
Adsorption to soil or precipitation out of solution	<ul style="list-style-type: none"> • Water solubility • K_{OW} (octanol/water partition coefficient) • K_{OC} • Oxidation state (metals)* 	<ul style="list-style-type: none"> • Presence of natural carbon compounds • Soil type, temperature, and chemistry • Presence of other compounds
Biologic uptake	<ul style="list-style-type: none"> • K_{OW} 	<ul style="list-style-type: none"> • Groundwater use for irrigation and livestock watering

Table 4.2 Chemical and Site Specific Factors That May Affect Contaminant Transport (continued)

Transport Mechanism	Factors Affecting Transport	
	Chemical-specific considerations	Site-specific considerations
Soil (Surface and Subsurface), Sediment, Sludge, Waste Materials (Site-specific factors for Waste Materials are at the conclusion of this table)		
Runoff (soil erosion)	<ul style="list-style-type: none"> • Water solubility • K_{oc} 	<ul style="list-style-type: none"> • Presence of plants • Soil type and chemistry • Precipitation rate • Configuration of land and surface condition
Leaching	<ul style="list-style-type: none"> • Water solubility • K_{oc} 	<ul style="list-style-type: none"> • Soil type • Soil porosity and permeability • Soil chemistry (especially acid/base) • Cation exchange capacity • Organic carbon content
Volatilization	<ul style="list-style-type: none"> • Vapor pressure • Henry's Law Constant 	<ul style="list-style-type: none"> • Physical properties of soil • Chemical properties of soil • Climatologic conditions
Biologic uptake	<ul style="list-style-type: none"> • Bioconcentration factor • Bioavailability 	<ul style="list-style-type: none"> • Soil properties • Contaminant concentration

Table 4.2 Chemical and Site Specific Factors That May Affect Contaminant Transport (continued)

Transport Mechanism	Factors Affecting Transport	
	Chemical Specific considerations	Site-specific considerations
Surface Water		
Overland flow (via natural drainage or man-made channels)	<ul style="list-style-type: none"> • Water solubility • K_{OC} 	<ul style="list-style-type: none"> • Precipitation (amount, frequency, duration) • Infiltration rate • Topography (especially gradients and sink holes) • Vegetative cover and land use • Soil/sediment type and chemistry • Use as water supply intake areas • Location, width, and depth of channel; velocity; dilution factors; direction of flow • Floodplains • Point and nonpoint source discharge areas
Volatilization	<ul style="list-style-type: none"> • Water solubility • Vapor pressure • Henry's law constant 	<ul style="list-style-type: none"> • Climatic conditions • Surface area • Contaminant concentration
Hydrologic connection between surface water and groundwater	<ul style="list-style-type: none"> • Density 	<ul style="list-style-type: none"> • Groundwater/surface water recharge and discharge • Stream bed permeability • Soil type and chemistry • Geology (especially Karst conditions)
Adsorption to soil particles and sedimentation (of suspended and precipitated particles)	<ul style="list-style-type: none"> • Water solubility • K_{OW} • K_{OC} • Density 	<ul style="list-style-type: none"> • Particle size and density • Geochemistry of soils/sediments • Organic carbon content of soils/sediment
Biologic uptake	<ul style="list-style-type: none"> • K_{OW} • Bioconcentration factor 	<ul style="list-style-type: none"> • Chemical concentration • Presence of fish, plants, and other animals

Table 4.2 Chemical and Site Specific Factors That May Affect Contaminant Transport (continued)

Transport Mechanism	Factors Affecting Transport	
	Chemical-specific considerations	Site-specific considerations
Air		
Aerosolization	<ul style="list-style-type: none"> • Water solubility 	<ul style="list-style-type: none"> • Chemicals stored under pressure
Atmospheric deposition	<ul style="list-style-type: none"> • Particle size 	<ul style="list-style-type: none"> • Rainfall/wind
Volatilization	<ul style="list-style-type: none"> • Henry's law constant 	<ul style="list-style-type: none"> • Presence of open containers, exposed surfaces, or leaking equipment
Wind	NA	<ul style="list-style-type: none"> • Speed, direction, atmospheric stability

Table 4.2 Chemical and Site Specific Factors That May Affect Contaminant Transport (continued)

Transport Mechanism	Factors Affecting Transport	
	Chemical-specific considerations	Site-specific considerations
Waste Materials (Site-Specific Factors only)		
Surface water runoff	NA	<ul style="list-style-type: none"> • Waste type • Integrity of contaminant • Integrity of containers, impoundments, and other structures • Climatic conditions
Leaching		
Groundwater movement		
Volatilization		

NA – Not Applicable

* denotes addition to ATSDR table

4.2.3 Exposure Points (The third element of an exposure pathway)

Exposure point means a location of potential contact between a contaminant and an organism. Table 4.3 lists potential exposure points for the different environmental media.

Table 4.3 Example Potential Exposure Points

Media Type	Example Potential Exposure Points
Groundwater	Wells and springs used for municipal, domestic, industrial and agricultural purposes
Surface water	Recreational water activities
Surface soil	Dermal contact for residents, on-site workers, visitors and trespassers
Subsurface soil	Dermal contact for residents and on-site workers involved in excavation, digging and other activities that turn over soil (e.g. planting trees)
Sediment	Dermal contact for swimmers, workers and others coming in contact with submerged or exposed sediment
Air	Inhalation of indoor or outdoor air that migrate from surface or subsurface soils
	Inhalation of indoor or outdoor air or particulates that are windblown from an upgradient source
Food chain	Ingestion of plants, animals or other food products that have contacted contaminated soil, sediment, waste materials, groundwater, surface, water or air

4.2.4 Exposure Routes (The fourth element of an exposure pathway)

Exposure route means the way a contaminant comes into contact with an organism. In general, individuals may be exposed to contaminants in environmental media in one or more of the following ways: ingestion, inhalation or dermal contact. In an exposure pathway evaluation, identification of viable routes for each exposure point is necessary. Temporal (changing patterns of land use over time) and spatial (variations in locations and levels of contaminants) considerations should be taken into account during exposure pathway evaluation (ATSDR, 2005). Table 4.1 and Figure 4.3 detail examples of exposure routes.

4.2.5 Receptor/Population (The fifth element of an exposure pathway)

Each site is unique and should be considered individually to determine factors that could enhance or hinder the frequency and magnitude of human and/or ecological exposure. A thorough analysis identifies past, present and potential future exposed populations and the extent of exposures via different exposure pathways. There also can be dramatic variability in exposure potential across receptor populations at a site. It is important to be as explicit as possible about the extent to which a given population may or may not come in contact with a contaminated environmental medium.

Some questions to ask when characterizing potentially exposed populations are:

- *Who/What* are exposed?
- *What* activities are occurring?
- *Where* are activities occurring?
- *When* has exposure occurred (past, current, future)? For how long?
- *How* are people exposed? How is the land used? Any unique exposure?

A review of land and natural resource use at or near the site will provide valuable information about the activities of the surrounding population and the probability for increased human exposure. Land use will significantly affect the types and frequency of human activities, thereby affecting the degree and intensity of human contact with water, soil, air, exposed wastes, or consumable plants and animals. Site access and use (e.g., work, play, riding, recreation, hunting, and fishing) need to be examined carefully. This kind of information can be obtained during the site visit, in site documentation, and through communications with community members and state, local, and tribal officials (ATSDR, 2005).

4.3 Receptor Descriptions

The following is a description of some receptors to be investigated during exposure pathway evaluation:

Residential: Typically a location where someone is present for an average of more than 8 hours a day. It includes, but is not limited to, schools, dwellings, residences, correctional facilities, any other human activity areas of repeated, frequent use and/or chronic duration and locations that typically house sensitive populations such as grade schools, hospitals, child care centers and nursing homes.

Construction: Typically, locations where construction activities are underway for a substantial period of time, *e.g.* months to years, resulting in sub-chronic exposures for on-site construction workers for only that period equal to the duration of the project.

Non-residential: Typically a location where someone is on-site an average of 8 hours a day, a typical work day. It includes, but is not limited to, all types of commercial and industrial operations, such as gas stations, dry cleaners, airports, marinas, municipal and military motor pools, trucking maintenance and refueling terminals, and commercial agricultural operations. This non-residential category may further be refined into commercial or industrial uses. These are locations where employees work, but do not reside on a continuing basis. Hotels, motels, and other transient activities (*e.g.* trespassers) are included in the non-residential definition, rather than as residential.

Recreational: Typically a location of intermittent and variable uses dependent upon the natural and man-made features present, and the geographical location. Therefore, the receptor uses and behavior patterns in this exposure scenario are highly site-specific. These locations include parks, playgrounds, golf courses, camping grounds, waters of the state with permitted uses, hiking areas, etc.

Off-Site Receptors: Land use within ¼ mile of the site should be surveyed. Where contaminant plumes extend or are likely to extend beyond ¼ mile of the property boundary, land use and receptors in those areas should be included in the receptor survey.

Sensitive Receptors such as schools, day care, hospitals, and nursing homes should be surveyed within a ¼ mile of the contaminant plume.

ADEQ's Eligibility and Evaluation model and EPA's Hazard Ranking System model require investigation of potential exposures populations over longer distances. Surface water should be surveyed to within 15 miles downstream of the contaminant plume. Drinking water wells should be surveyed to within 4 miles of the contaminant plume. If contamination is present in the upper 2 feet of soil, the population survey should evaluate potential exposure populations within 1 mile of the site.

4.4 Reference websites

A review of the following references may be useful for a more full understanding of exposure pathways.

<http://www.atsdr.cdc.gov/HAC/phamanual/ch6.html>

<http://www.envirotools.msu.edu/exposurepathways.shtml>

<http://www.epa.gov/radiation/understand/pathways.html>

http://www.publications.usace.army.mil/Portals/76/Publications/EngineerManuals/EM_200-1-12.pdf

October 2014 ADEQ Waste Programs Division
Site Investigation Guidance Manual

<http://www.azdhs.gov/documents/preparedness/epidemiology-disease-control/environmental-toxicology/guidance.pdf>

http://azdhs.gov/documents/preparedness/epidemiology-disease-control/environmental-toxicology/PerchlorateAZ_HBGL.pdf

Important Information You Should Know After Reading Section 5.0: The Triad Approach

1. [The three legs of the Triad Approach, what they represent and the central concept that ties them together.](#)
2. [The Triad Approach Process overview.](#)
3. [How the Triad Approach compares to the traditional Non-Dynamic approach to site investigations.](#)
4. [Some of the technologies available for real-time measurements utilized during field activities.](#)
5. [The two decision making processes that are integral to the Triad Approach and why each is useful.](#)

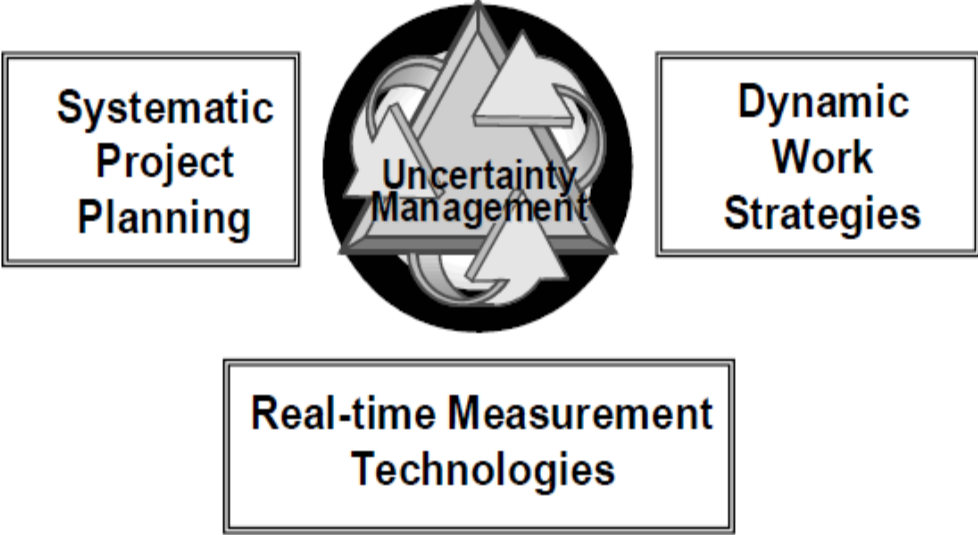
<p>The three legs of the Triad Approach:</p> <ol style="list-style-type: none"> 1. Systematic Project Planning (better investigation preparation); 2. Dynamic Work Strategies (greater flexibility while performing field work); and 3. Real-time Measurement Technologies (advocacy of real-time measurement technologies, including field-generated data). <p>The Central Concept:</p> <ol style="list-style-type: none"> 1. The need to understand and manage uncertainties (i.e. data gaps) <div style="text-align: center;"> <p>The Triad Approach</p>  </div>	<p>Triad Approach Process Overview</p> <p>SYSTEMATIC PROJECT PLANNING Project Initiation</p> <ul style="list-style-type: none"> • Assemble project team • Define project objectives • Identify key decision makers • Define decisions to be made • Develop initial conceptual site model (CSM) <p>DYNAMIC WORK STRATEGY Project Start-up</p> <ul style="list-style-type: none"> • Ongoing revision of the CSM • Draft adaptive work plan and sampling strategy/decision logic • Develop detailed analytical strategy: field-based or fixed lab • Develop data management plan • Develop quality assurance plan • Develop health and safety plan <p>ADAPTIVE WORK PLAN IMPLEMENTATION Plan Approval</p> <ul style="list-style-type: none"> • Sampling and analysis to fill data gaps • Data validation, verification, and assessment <p>REAL-TIME MEASUREMENT TECHNOLOGIES Field Program</p> <ul style="list-style-type: none"> • Sampling and analysis to fill data gaps • Data validation, verification, and assessment <p>DECISION MAKING Are Project Objectives Met?</p> <ul style="list-style-type: none"> • Evolve/refine CSM • Modify adaptive work plan • Client/stakeholder/regulatory review/approval 	<p>Some Technologies available for real-time measurements (Direct Sensing Technologies):</p> <ol style="list-style-type: none"> 1. LIF/UVF methods; 2. Geophysical tools (surface and downhole); 3. Membrane Interface Probes (PID, FID, ECD, XSD) 4. Neutron Gamma Monitors 5. Hydraulic conductivity profilers 6. CPT <p>Some Technologies available to for real-time measurements (Field Generated Real-Time Measurement Technologies):</p> <ol style="list-style-type: none"> 1. Direct Push Samplers; 2. Immunoassay/Bioassay test kits; 3. Miscellaneous colorimetric kits; 4. Mobile laboratory; 5. Field GC and GC/MS; 6. Passive diffusion samplers; 7. Permeameter; 8. Conventional drilling.
---	--	---

Comparison between the Triad Approach and the traditional Non-Dynamic approach to site investigations:

1. The Triad Approach utilizes real-time measurement technology;
2. The Triad Approach takes away uncertainty with fewer mobilizations;
3. There may be more upfront costs with the Triad Approach, but the payoff is a quicker site investigation completion time with less uncertainty.
4. The Triad Approach has the likely prospect of the overall project costs being less than the non-dynamic approach.

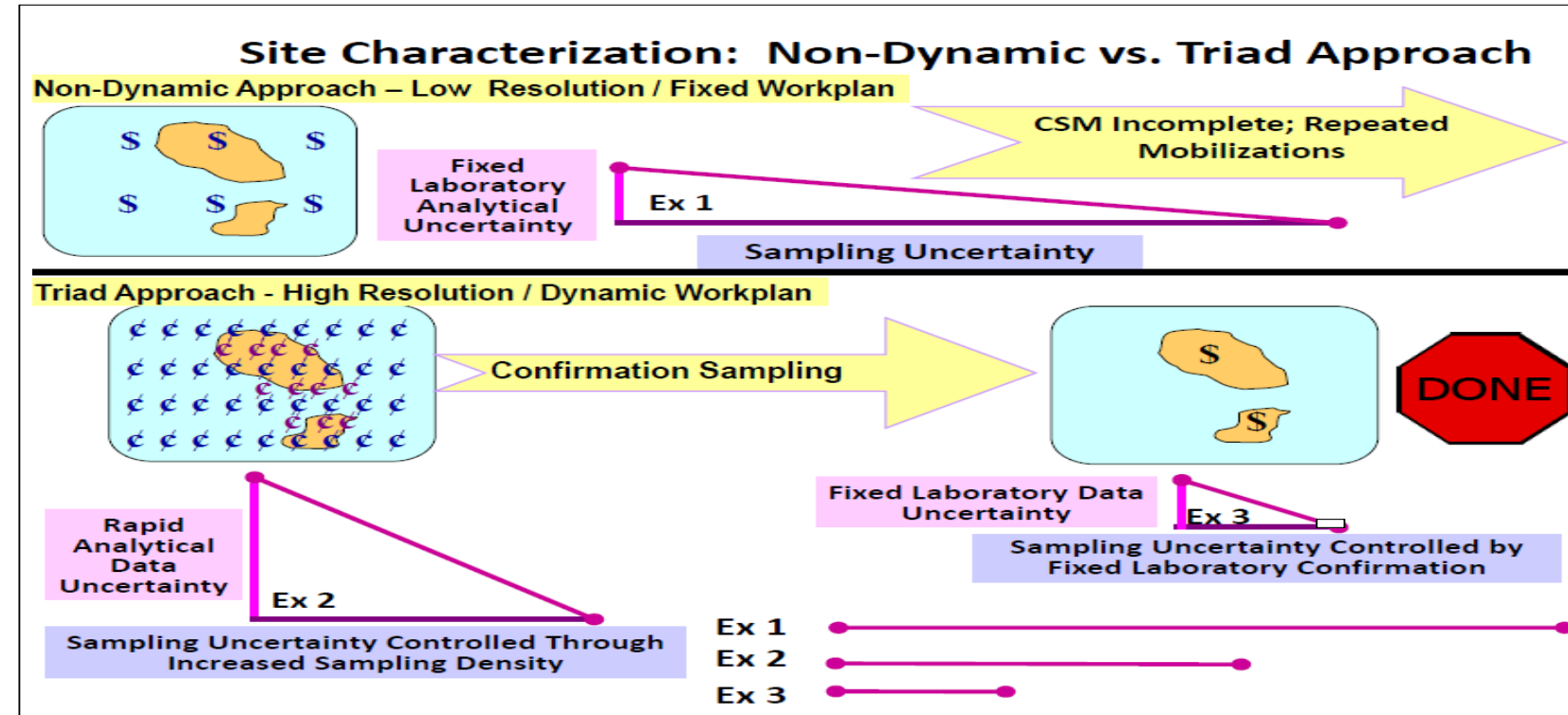

The Two Decision Making Processes within the Triad Approach:

1. Rational Choice Strategy (RCS):
 - a. Classical decision analysis method;
 - b. Ideally suited as a decision model for the systematic planning leg of the Triad Approach (i.e. before field work begins);
 - c. Identifies set of options and ways to evaluate those options;
 - d. Deliberative, quantitative, systematic approach to complex problems;
 - e. Reduces the chance an important consideration will be overlooked;
 - f. Protects novices from making poor choices; and
 - g. Is useful when working in teams under minimal time pressure.

2. Recognition-primed Decision Model (RPD):
 - a. Naturalistic method that combines two decision processes: pattern and cue recognition and mental simulation;
 - b. Ideally suited as the decision model for the dynamic work strategies leg of the Triad Approach (i.e. during field work);
 - c. Decision-makers use prior experience to jump to the right answer without sorting through all available options as done in RCS;
 - d. Experienced decision-makers coordinate a team under time pressure and high stakes, often under rapidly changing conditions or inadequate information; and
 - e. Decision maker should be prepared to adapt.

Section 5.0 Planning Investigation of Contamination

Site investigation is one of the initial steps in the environmental site assessment and remedial response process. This typically involves the investigation of soil, groundwater and surface water as a means to assess exposure pathways, to determine the nature and extent of contamination, and to assist in the development of an effective remediation strategy.

Site investigation activities should be planned and carried out to meet the following objectives:

1. Continued development of an increasingly detailed CSM through the ongoing assessment of all exposure pathways;
2. Identify physical, natural, and artificial features at or surrounding the site that are current or potential pathways for contaminant migration;
3. Identify current and potential receptors and the existing and potential adverse effects to receptors;
4. Determine, within each contaminated medium, the full extent, location, and distribution of concentrations of each COCs;
5. Develop an accurate understanding of the site geology and hydrology;
6. Obtain any additional data necessary to determine site-specific cleanup standards; and
7. Obtain any additional data to develop a feasibility study to justify the selection of potentially effective and appropriate corrective actions.

Physical and chemical investigations:

As the site investigation proceeds, additional data is obtained which provides information on whether exposure pathways are complete, potentially complete or incomplete. The CSM should be updated accordingly with this data and used for decision-making regarding risk-based evaluation and selection of a remedial approach among feasible alternatives. The components of the CSM which are found to be complete should be sufficiently characterized to determine the level at which a receptor may be exposed to COCs. For those components of the CSM which may lead to a potentially complete or complete exposure pathway, further site characterization or data collection should be conducted to determine if a receptor will be exposed, and at what levels.

Focused data collection for an exposure pathway does not need to proceed further when it can be demonstrated that:

1. A receptor is not currently or potentially exposed; or
2. Exposure levels do not pose an unacceptable risk; or
3. Levels in soil, groundwater and surface water do not exceed cleanup standards.

Site-specific data should support these demonstrations.

5.1 Systematic Planning Methods for Environmental Data Collection

Systematic planning is a widely-accepted approach for environmental data collection and includes concepts such as objectivity of approach and acceptability of results. Systematic planning should use a common-sense approach to ensure that the level of documentation and rigor of effort in planning is commensurate with the intended use of the information and the available resources. Systematic planning includes well-established management and scientific elements that result in a project's logical development, efficient use of scarce resources, transparency of intent and direction, soundness of project conclusions, and proper documentation to allow determination of appropriate level of peer review.

The Data Quality Objectives (DQO) Process and the Triad Approach are two systematic planning methods. Both methods were developed by EPA and are consistent with each other.

5.1.1 DQO Process

EPA (2006) describes the DQO Process as a series of logical steps that guides managers or staff to a plan for the resource-effective acquisition of environmental data. It is both flexible and iterative, and applies to both decision-making (e.g., compliance/non-compliance with a standard) and estimation (e.g., ascertaining the mean concentration level of a contaminant). The DQO Process is used to establish performance and acceptance criteria, which serve as the basis for designing a plan for collecting data of sufficient quality and quantity to support the goals of the study or decision making. Use of the DQO Process: 1) leads to efficient and effective expenditure of resources; 2) will assure that the type, quality, and quantity of data used to meet the project goals will be appropriate for the intended application; and 3) will allow for the full documentation of actions taken during the development of the project.

The DQO Process consists of seven iterative steps, as detailed below and outlined in Figure 5.1. While the interaction of these steps is portrayed in a sequential fashion, the iterative nature of the DQO Process allows one or more of these steps to be revisited as more information on the problem is obtained and the CSM is revised.

The DQO Process is as follows:

Step 1 – State the Problem: Define the problem that necessitates the study; identify the planning team, examine budget, schedule

Step 2 – Identify the Goal of the Study: State how environmental data will be used in meeting objectives and solving the problem, identify study questions, define alternative outcomes

Step 3 – Identify Information Inputs: Identify dates and information needed to answer study questions

Step 4 – Define the Boundaries of the Study: Specify the target population and characteristics of interest, define spatial and temporal limits, scale of inference

Step 5 – Develop the Analytic Approach: Define the parameter of interest, specify the type of inference, and develop the logic for drawing conclusions from findings

Step 6 (Decision making/hypothesis testing) – Specify Performance or Acceptance Criteria: Specify probability limits for false rejection and false acceptance decision errors. This statement refers to the statistical confidence that a specific Null hypothesis is correct. Typically, a 95% confidence limit or 95% population estimate is used for the alternative being tested.

Step 6 (Estimation and other analytic approaches) – Specify Performance or Acceptance Criteria: Develop performance criteria for new data being collected or acceptable criteria for existing data being considered for use

Step 7 – Develop the Plan for Obtaining Data: Select the resource-effective sampling and analysis plan that meets the performance criteria

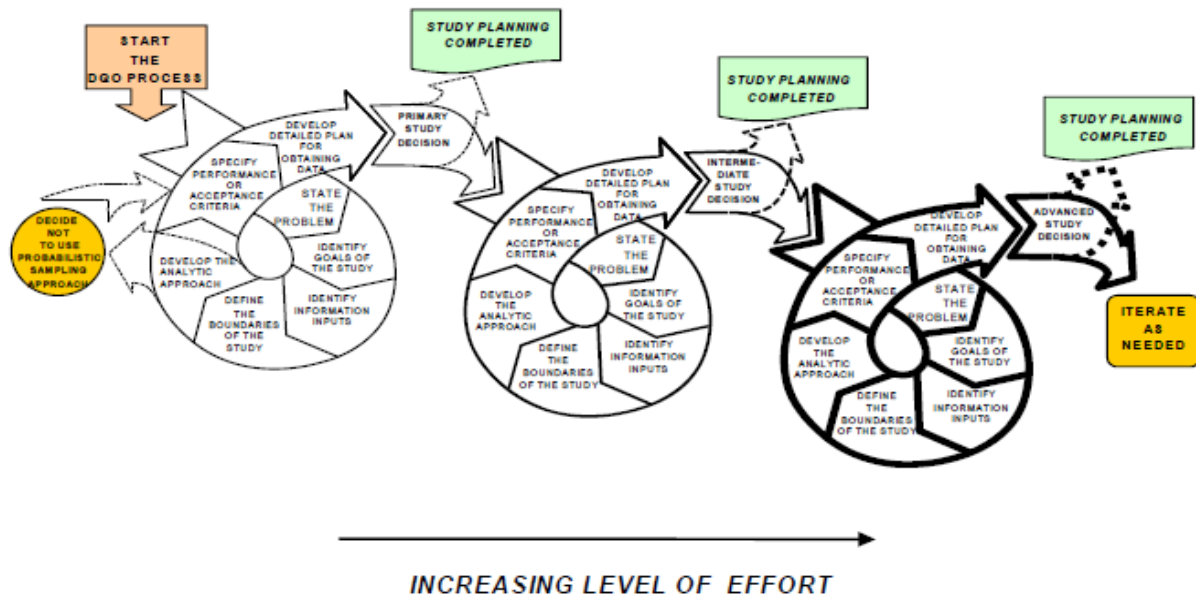

Figure 5.1 The Data Quality Objective (DQO) Process (EPA, 2006)

The reader is referred to EPA's 2006 Guidance on Systematic Planning using the Data Quality Objectives Planning Process (<http://www.epa.gov/QUALITY/qs-docs/g4-final.pdf>) for more discussion on the concepts of the DQO Process.

5.1.2 Triad Approach

The ITRC (2003) provides an overview of the Triad Approach in the following way:

The concepts embodied in the three legs of the Triad Approach are (1) systematic project planning, (2) dynamic work strategies, and (3) real-time measurement technologies (Figure 5.2).

The Triad Approach can be thought of as an initiative to update the environmental restoration process by providing a better union of scientific and societal factors involved in the resolution of contamination issues. It does this by emphasizing better investigation preparation (systematic project planning), greater flexibility while performing field work (dynamic work strategies), and advocacy of real-time measurement technologies, including field-generated data. The central concept that joins all of these ideas is the need to understand and **manage uncertainties** (i.e. data gaps) that affect decision making. Table 5.1 provides an overview of the Triad Approach process.

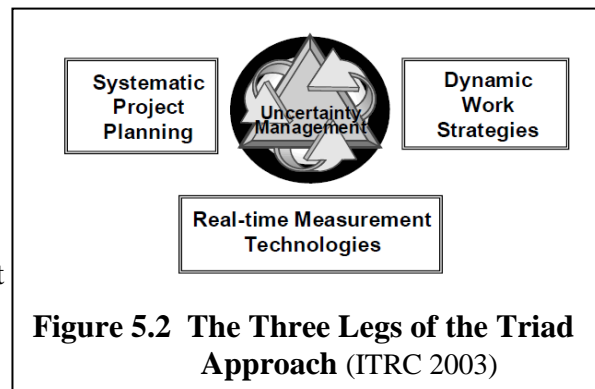

5.1.2.1 Comparison of Non-Dynamic and Dynamic Work Strategies

Figure 5.3 compares a difference between using a Non-Dynamic Approach (e.g. the DQO process) against the Triad Approach during site investigations. Please note that the Triad Approach utilizes Real-Time Measurement technology and takes away sampling uncertainty with fewer mobilizations. There may be more upfront costs with the Triad Approach but the payoff is a quicker completion time with less uncertainty and the likely prospect of less overall cost. Table 5.2 is a listing of some technologies that can be utilized to collect real-time data.

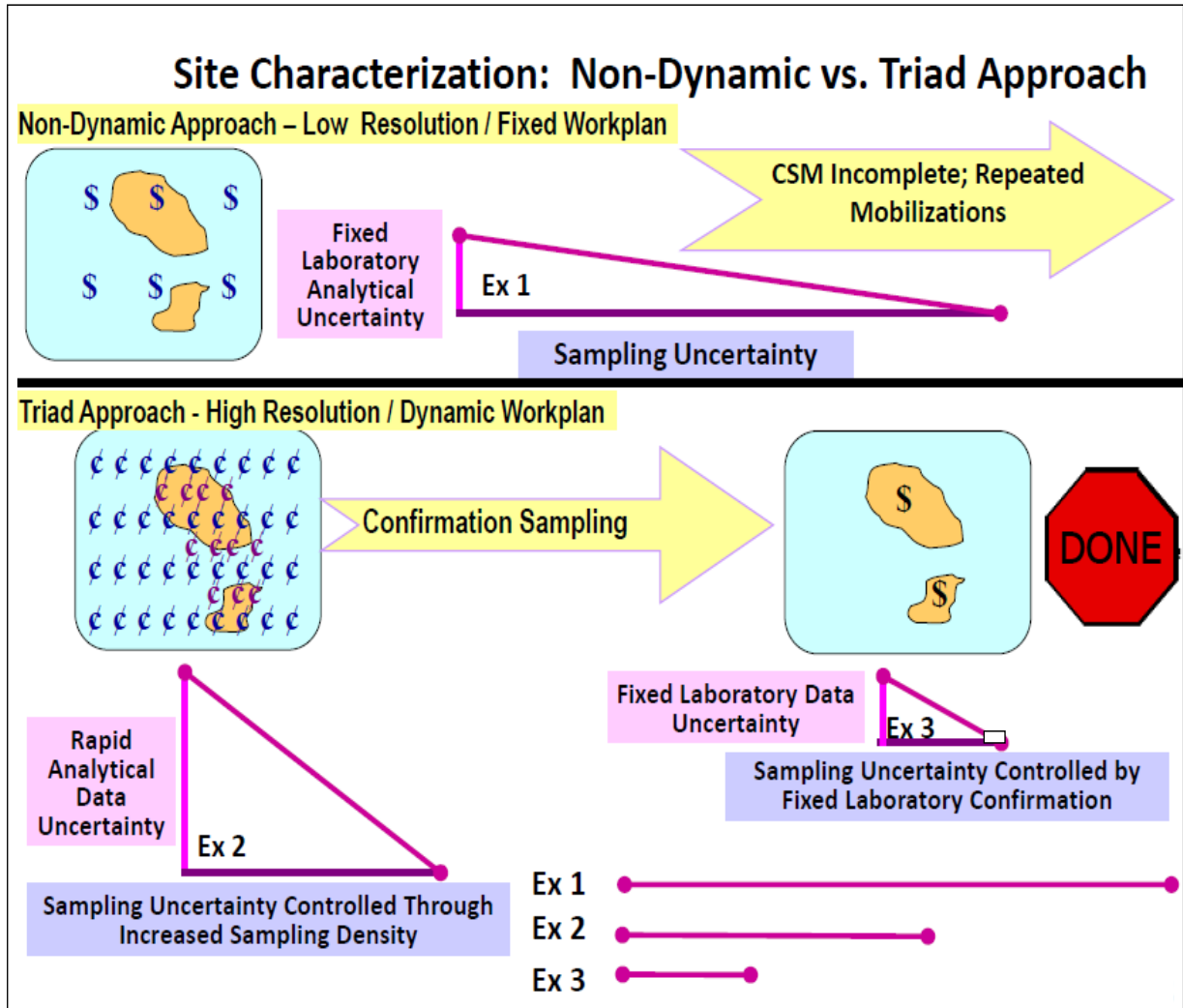

Figure 5.3 Comparison of Non-Dynamic Approach versus the Triad Approach.
 Please note that the hypotenuse lengths of the triangles represent the non-dynamic or Triad approach uncertainties. A shorter hypotenuse length indicates less uncertainty in the approach. (ITRC, 2003)

Table 5.1 Triad Approach Process Overview (Modified from ITRC, 2003)

<p>SYSTEMATIC PROJECT PLANNING</p>	<p>Project Initiation</p> <ul style="list-style-type: none"> ● Assemble project team ● Define project objectives ● Identify key decision makers ● Define decisions to be made ● Develop initial conceptual site model (CSM) 	<p>Answers:</p> <ul style="list-style-type: none"> ● Who ● What ● Why
<p>DYNAMIC WORK STRATEGY</p>	<p>Project Start-up</p> <ul style="list-style-type: none"> ● Ongoing revision of the CSM ● Draft adaptive work plan and sampling strategy/decision logic ● Develop detailed analytical strategy: field-based or fixed lab ● Develop data management plan ● Develop quality assurance plan ● Develop health and safety plan 	<p>Answers:</p> <ul style="list-style-type: none"> ● What ● Why ● How ● When ● Where ● Who
<p>ADAPTIVE WORK PLAN IMPLEMENTATION</p>	<p>Plan Approval</p> <ul style="list-style-type: none"> ● Client/regulator/stakeholder review/approval ● Refine project decision logic and finalize plans 	<p>Answers:</p> <ul style="list-style-type: none"> ● Who ● What ● Why ● How
<p>REAL-TIME MEASUREMENT TECHNOLOGIES</p>	<p>Field Program</p> <ul style="list-style-type: none"> ● Sampling and analysis to fill data gaps ● Data validation, verification, and assessment 	<p>Answers:</p> <ul style="list-style-type: none"> ● When ● Who ● Where ● How ● What
<p>DECISION MAKING</p>	<p>Are Project Objectives Met?</p> <ul style="list-style-type: none"> ● Evolve/refine CSM ● Modify adaptive work plan ● Client/stakeholder/regulatory review/approval 	<p>Answers:</p> <ul style="list-style-type: none"> ● Why ● What ● How ● Who

Table 5.2 Direct Sensing and Field Generated Real Time Measurement Technology

Direct Sensing Real-Time Measurement Technology

Technology	Matrices	Data Provided
LIF/UVF methods (Lasers, UV lamp)	Water, soil	TPH, PAH, Coal Tar
Geophysical tools – surface EM, Resistivity, GPR, acoustic/seismic	Soil, fill bedrock	Sources, pathways, macro-stratigraphy, and buried objects
XRF (screening and definitive)	Soils, material surfaces	Metals
Membrane Interface Probe (PID, FID, ECD, XSD)	Soil, water	VOCs, hydrocarbons, and DNAPL
Neutron Gamma Monitors	Soil, water, material surfaces	Radiation
Hydraulic conductivity profilers	Soil, water	Hydraulic conductivity, lithology
Geophysics – downhole (natural gamma ray, self potential, resistivity, induction, porosity/density, and caliper)	Soil, fill, bedrock	Lithology, groundwater flow, structure, permeability, porosity, and water quality
CPT, high-resolution piezocone	Soil, water	Lithology, groundwater flow
SimulProbe®	Soil, water	Vertical Aquifer Profiling (VAP)
Hydropunch™	Water	Vertical Aquifer Profiling (VAP)

Field Generated Real-Time Measurement Technology

Technology	Matrices	Data Provided	Relative Cost
Direct push samplers	Water, soil, active soil vapor	Sample, physio-visual data	\$\$\$\$
Immunoassay/Bioassay test kits	Water, soil, material surfaces	SVOCs, PCBs, pesticides, and Dioxins/Furans	\$
Miscellaneous colorimetric kits	Water, air	Water quality, hazardous vapor	\$
Mobile laboratory – definitive	Water, soil	VOCs, SVOCs, pesticides, PCBs, explosives, metals, and wet chemistry	\$\$\$
Field GC and GC/MS – screening	Water, soil	VOCs, SVOCs, pesticides, PCBs, and explosives	\$\$
Passive diffusion samplers	Water, soil vapor	VOCs, SVOCs, and contaminant flux	\$
Permeameter	Soil	Hydraulic conductivity	\$\$
Conventional drilling	Water, soil, bedrock	Physio-visual data, multiple constituents	\$\$\$\$

5.1.2.2 Management of Decision Uncertainty within the Triad Approach

There are two decision making processes that are integral to the Triad Approach, the **rational choice strategy (RCS)** and the **recognition-primed decision model (RPD)**. Both decision making processes have an important place in the Triad Approach. Expert Triad practitioners freely move between both strategies as the project progresses.

Crumbling et al. (2004) contrasts these two decision making processes in the following way:

Rational Choice Strategy:

The RCS can be thought of as the classical decision analysis method. When applying a RCS the decision-maker identifies a set of options and ways to evaluate those options. He weights each evaluation criteria, ranks options with the weighted criteria, and picks the option with the highest score. Listing and counting “pros and cons” is an example of a rational choice strategy.

Recognition-primed Decision Model:

The RPD is a naturalistic method that combines two decision processes: pattern and cue recognition and mental simulation. In RPD, the decision-makers use prior experience to jump to the right answer without sorting through all available options as done in RCS.

The RCS is ideally suited as a decision model for the systematic planning element (i.e. the first leg of the Triad Approach). RCS provides a deliberate, quantitative, systematic approach to complex problems. It reduces the chances that an important consideration will be overlooked. It also allows for more in-depth analysis of many options. RCS protects novices from making poor choices, and is useful when working in teams under minimal time pressure. The RCS decision model gives all participants a sense of order, structure, and confidence that all worthwhile strategies have been considered and contingencies addressed (Crumbling et al., 2004).

In contrast, the RPD model is applicable in decision-making environments where experienced decision-makers coordinate a team under time pressure and high stakes, often under rapidly changing conditions or inadequate information. The decision-maker should be prepared to adapt. Emergency personnel and soldiers work under these kinds of conditions. The dynamic work strategies element (i.e. the second leg of the Triad Approach) exhibits many or all of these characteristics, so the RPD model is most applicable to that phase of a Triad project (Crumbling et al., 2004).

5.1.2.3 Example of Recognition-primed Decision

Situation:

The Baseline CSM indicates an uncertainty of the risk posed by contaminated groundwater to an offsite potable water well. The workplan calls for: 1) sampling of the potable water well; 2) installing six monitor wells at and near the source area; and 3) installing several more monitoring wells between the source area and the potable water well. During the field investigations, several low-flow purge depth specific samples were collected from the potable water well and real time measurements (from a mobile laboratory) were collected. The data indicated that the potable water supply well did not have any detectable COCs. Also, depth specific groundwater samples (direct push sampling) were collected from the property boundary of the contaminated site. The data indicated that COCs were at or below regulatory standards in those samples.

Recognition-primed decision:

Although the workplan called for the installation of several wells, the real-time field data indicates that several monitor wells were not necessary. The workplan was flexible enough to forgo the installation of many of the approved monitoring well installations. The decision to install only a portion of the approved monitoring wells would be a justified RPD change to the workplan.

5.1.3 Comparing the Triad Approach Against the DQO Process

The Triad Approach was developed to utilize technology to make real time management decisions and ultimately cut down the time and costs to complete environmental projects. The DQO process is the traditional approach for decision management.

The DQO process differs from the Triad Approach in that the DQO process emphasizes an iterative sequential approach to investigation (mobilize to field, collect data, go to office, review data and repeat until characterization is complete). The DQO process is typically more time consuming and costly than the Triad Approach.

5.1.4 Reference Websites

The reader is referred to the following weblinks for further information on the DQO Process and the Triad Approach:

[EPA's 2006 Guidance on Systematic Planning using the Data Quality Objectives Planning Process](#)

[Traditional Approach comparison with Dynamic Approach – powerpoint presentation](#)

[December 2003 ITRC – The Triad Approach: A new Paradigm for Environmental Project Management](#)

[May 2007 ITRC – The Triad Implementation Guide](#)

[Crumbling – March 2004 White Paper](#)

[The Maturing of the Triad Approach: Avoiding Misconceptions - Crumbling 2004](#)

[Managing Uncertainty in Environmental Decisions - 2001](#)

[The Triad Approach: A Catalyst for Maturing Remediation Practice \(Crumbling et al., 2004\)](#)

[Powerpoint – the Triad Approach to Managing Decision Uncertainty for Better Cleanup Projects](#)

[Powerpoint – The Triad Approach Moves Beyond 1980's thinking](#)

Important Information You Should Know after Reading Section 5.2 - Sampling Considerations – Decision Units:

1. [The ways to define decision units.](#)
2. [The basic activities and outputs for assigning decision units at a site.](#)
3. [The difference between the two primary types of decision units.](#)

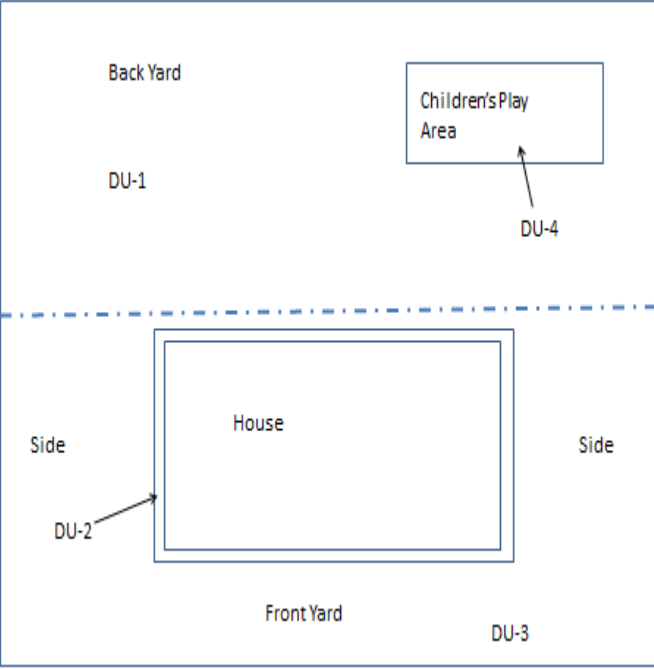
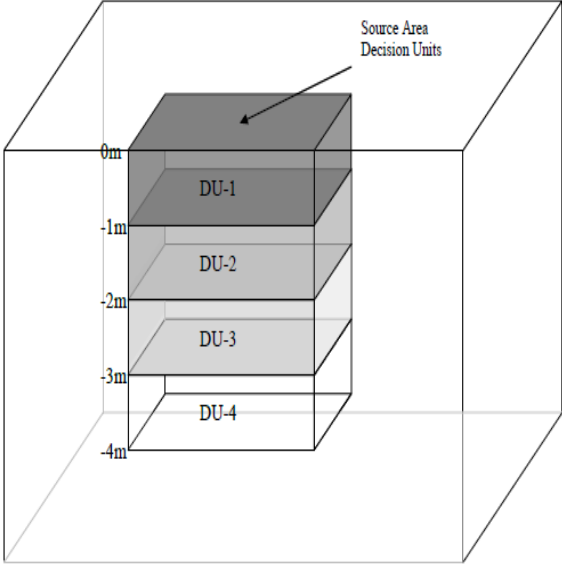
<p>Ways to Define Decision Units:</p> <p>A Decision Unit (DU) is an area (volume, when thickness is a key factor) where a decision is to be made regarding the extent and magnitude of contaminants with respect to potential environmental hazards posed by existing or anticipated future exposure to the contaminants. DU's can be defined:</p> <ol style="list-style-type: none"> 1) in regularly spaced and equal volumes as established by exposure areas; 2) based on irregular features of the site which define contaminant transport or receptor exposure; 3) based on an understanding of the contaminant distributions, for example, in and around source areas; 4) based on human health or ecological exposure areas (e.g., children's play areas or schoolyards); or 5) based on the needs of remediation or excavation (e.g., landfill construction; sidewalls and floors of excavations for confirmation of sufficient soil removal). 	<p>Basic Activities and Outputs for DU Assignment:</p> <table border="0"> <tr> <td style="vertical-align: top;"> <p>Activities</p> <ul style="list-style-type: none"> • Define the geographic boundaries of the area of interest • Identify temporal issues/sampling components for groundwater or ecological risk evaluations • Specify DU type, size, location, and shape (includes depth of soil DUs) • Identify particle size of interest and if surface organic matter will be sampled (for soil investigations) • Identify practical constraints (resources, accessibility, etc). </td> <td style="vertical-align: top;"> <p>Outputs</p> <ul style="list-style-type: none"> • Definition of the project boundaries • Description and rationale for selection of DUs • Description of soil particle size to be collected and if organic matter at surface will be sampled • Description of constraints on selection and investigation of DUs </td> </tr> </table>	<p>Activities</p> <ul style="list-style-type: none"> • Define the geographic boundaries of the area of interest • Identify temporal issues/sampling components for groundwater or ecological risk evaluations • Specify DU type, size, location, and shape (includes depth of soil DUs) • Identify particle size of interest and if surface organic matter will be sampled (for soil investigations) • Identify practical constraints (resources, accessibility, etc). 	<p>Outputs</p> <ul style="list-style-type: none"> • Definition of the project boundaries • Description and rationale for selection of DUs • Description of soil particle size to be collected and if organic matter at surface will be sampled • Description of constraints on selection and investigation of DUs
<p>Activities</p> <ul style="list-style-type: none"> • Define the geographic boundaries of the area of interest • Identify temporal issues/sampling components for groundwater or ecological risk evaluations • Specify DU type, size, location, and shape (includes depth of soil DUs) • Identify particle size of interest and if surface organic matter will be sampled (for soil investigations) • Identify practical constraints (resources, accessibility, etc). 	<p>Outputs</p> <ul style="list-style-type: none"> • Definition of the project boundaries • Description and rationale for selection of DUs • Description of soil particle size to be collected and if organic matter at surface will be sampled • Description of constraints on selection and investigation of DUs 		
<p>Two Primary Types of Decision Units:</p> <ol style="list-style-type: none"> 1. Source area DU – based on the known or suspected locations and dimensions of source areas. Facilities such as drycleaners and gas stations are typically associated with source area DUs; 2. Exposure area DU – based on the size assumptions of risk assessment. Mining facilities and their surrounding areas and any industry associated with air to surface deposition (e.g. aerial spraying of pesticides over farmland) are typically associated with exposure area DUs. <p>Source areas include the following:</p> <ol style="list-style-type: none"> a) areas with stained soil, known contamination, obvious releases b) areas where contaminants were suspected to be stored, handled, or disposed c) areas where <i>sufficient sampling evidence</i> indicates elevated concentrations relative to the surrounding soil over a <i>significant volume</i> of contaminated media <p>In the Exposure Area DU example, the backyard, children's play area and front/side yards were designated as separate DUs based on anticipated use patterns due to higher frequency of exposure. DU-2 consists of the drip-line of the house, which is suspected to contain elevated levels of lead in the soil.</p> <p>In the Source Area DU example, one-meter vertical resolution of source area DUs were selected to help isolate heavily contaminated soil from less-contaminated soil and assist in evaluation of remedial alternatives.</p>	<p>Example of Exposure Area DU's:</p>  <p>Example of Source Area DU:</p> 		

5.2 Sampling Considerations – Decision Units

The following discussion in this section is modified from in Section 3.3 through 3.5 of [ITRCs February 2012 Technical and Regulatory Guidance – Incremental Sampling Methodology](#).

Developing sampling objectives is an important step in guiding the investigation. The systematic planning process discussed in Section 5.1 outlines the steps that should be followed to ensure the data will meet its intended purpose. As an example, the objective may be to determine whether the concentration of lead in a specific area exceeds Arizona’s residential soil remediation level (rSRL) of 400 mg/kg. To accomplish the objective, the systematic planning process should be followed to: 1) identify a decision unit(s) in which to sample; 2) possibly specify a statistical test; and 3) develop a decision rule which specifies the actions to be taken if the sampling data exceeds the rSRL. Decision Units are discussed below.

A Decision Unit (DU) is an area where a decision is to be made regarding the extent and magnitude of contaminants with respect to potential environmental hazards posed by existing or anticipated future exposure to the contaminants. Strictly speaking, a decision unit is really a volume rather than area of soil, because the thickness of the decision unit is often a key factor. DUs are based on project-specific needs and site-specific DQOs. Defining site-specific DUs is critical to systematic planning of an environmental investigation.

There are several approaches to assigning DUs to an environmental project. The approach selected should be consistent with the understanding of the site reflected in the CSM and should support the objectives of the investigation. DUs may be defined:

1. in regularly spaced and equal volumes as established by exposure areas;
2. based on irregular features of the site which define contaminant transport or receptor exposure;
3. based on an understanding of the contaminant distributions, for example, in and around source areas;
4. based on human health or ecological exposure areas (e.g., children’s play areas or schoolyards); or
5. based on the needs of remediation or excavation (e.g., landfill construction; sidewalls and floors of excavations for confirmation of sufficient soil removal).

Volumes of soil known or suspected to be contaminated are generally good candidates for designation as DUs because the decision over these volumes is best made separately from less-contaminated surrounding volumes.

Some basic activities and outputs for DU assignments is provided below:

Assigning Decision Units	
<p>Activities</p> <ul style="list-style-type: none"> • Define the geographic boundaries of the area of interest • Identify temporal issues/sampling components for groundwater or ecological risk evaluations • Specify DU type, size, location, and shape (includes depth of soil DUs) • Identify particle size of interest and if surface organic matter will be sampled (for soil investigations) • Identify practical constraints (resources, accessibility, etc). 	<p>Outputs</p> <ul style="list-style-type: none"> • Definition of the project boundaries • Description and rationale for selection of DUs • Description of soil particle size to be collected and if organic matter at surface will be sampled • Description of constraints on selection and

5.2.1 Decision Units – Primary Types

ITRC (2012) suggests two primary types of DUs: those based on the known or suspected locations and dimensions of source areas, called “source area DUs”, and those based on the size assumptions of risk assessment, called “exposure area DUs”.

ITRC (2012) defines a source areas as a discernible volume of soil (or waste or other media) containing elevated or potentially elevated concentrations of contaminant in comparison to the surrounding soil. Source areas include the following:

1. areas with stained soil, known contamination, obvious releases
2. areas where contaminants were suspected to be stored, handled, or disposed
3. areas where *sufficient sampling evidence* indicates elevated concentrations relative to the surrounding soil over a *significant volume* of contaminated media

This definition highlights the difference between types of DUs. Source area DUs are differentiated from exposure area DUs in that the boundaries of source area DUs and the scale of sampling are based on the *known or hypothesized extent of the contamination*, while the boundaries of exposure area DUs are determined through the *exposure assumptions of the risk scenario*.

5.2.1.1 Exposure Area Decision Units

An exposure area is the specified area throughout which a potential receptor is exposed. DUs based on exposure areas are a fundamental part of many environmental investigations and are a key tool in risk assessments and risk-based decision making. ITRC (2012) defines an “exposure area” as an area where human or ecological receptors

could come into (direct) contact with contaminants with soil on a regular basis. Examples include residential yards, schoolyards, playgrounds, gardens, areas of commercial/industrial properties, or areas designated as exposure areas through other means. Exposure area DUs are typically associated with relatively non-mobile contaminants such as arsenic, lead, PCBs, polychlorinated dibenzodioxins and polychlorinated dibenzofurans, etc.).

A common sampling objective for exposure area DU's is to collect site soil data for comparison with the pre-determined SRLs. The site data used to compare against the pre-determined SRLs should be based upon a spatially averaged concentration which is best represented by the 95% UCL of the pertinent site data. For a residential area, the 95% UCL is calculated over a typical residential sized lot which may be one-eighth to half an acre. For a non-residential area, the size of the exposure area is more variable and should be based upon site specific considerations. Pro-UCL is a convenient software program for the calculation of an upper confidence limit.

The example exposure area DUs in Figure 5.4 depict the investigation of an older, residential home that is suspected to have been built on top of a former pesticide mixing area. The objective of the investigation is to determine whether pesticides and lead in the soil pose a direct-exposure hazard to the residents. Contaminants include arsenic and dioxins as well as pesticides.

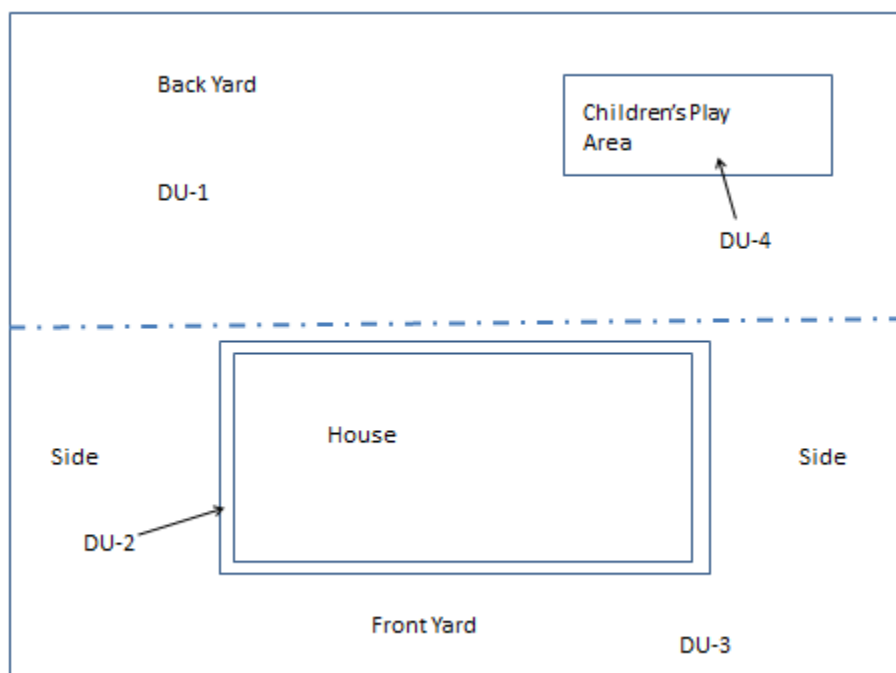

Figure 5.4 Exposure area DUs designated for a residential house lot. The backyard was designated as a separate DU from the front and side yards based on anticipated use patterns due to higher frequency of exposure.

Most of the yard is included in DU-1 because the exposure scenario consists of the assumption that an equal amount of time will be spent in all parts of the back yard (except the Children's Play Area) over the assumed exposure duration. Lead-based paint is suspected to have been used on the house; therefore DU-2 consists of the drip-line of the house, which is suspected to contain elevated levels of lead in the soil. DU-2 can be considered both an exposure-area DU and a source-area DU because it represents the exposure to chips of lead-based paint, which may be of concern for acute or subchronic exposure and is a potential source of lead. Exposure patterns in the front and side yard are different than in the backyard, therefore DU-3 is designated as the front and side yards. The children's play area is its own separate DU (DU-4) because the children will prefer this area of the backyard over the other areas (exposure is increased for the children in this area as compared to the other areas of the backyard).

The primary use of data from an exposure area DU is to estimate exposure and, subsequently, risk to human health and the environment. The data may also be used to screen sites for further study using criteria such as risk-based screening levels. This objective may be accomplished by comparison of the estimated mean concentration in the DU to soil remediation standards. If the project is more mature, data may be used to develop exposure point concentrations (EPCs) to quantify risks from exposures to contaminants by human and/or ecological receptors (ITRC, 2012 Section 3.3 through 3.5).

The CSM and the sampling objectives should be used to establish the sampling depth for the an exposure area DU. Often the upper six inches of soil is most important to define exposure. Deeper soil concentration data may be needed to evaluate exposure to utility workers.

5.2.1.2 Source Area Decision Units

Source areas are of concern because contamination can migrate from source areas to other locations and media (e.g., leaching to groundwater, volatilizing to soil vapor and/or indoor air, or running off to surface water). Source areas can also result in additional releases, direct exposures, and other issues associated with gross contamination (e.g., risk of explosion, nuisance issues, or inappropriate disposal). The identification and

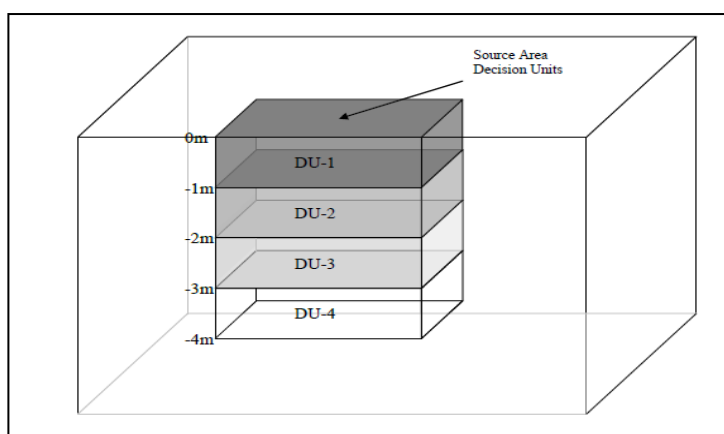

Figure 5.5 Source Area DU Example. One-meter vertical resolution of source area DUs were selected to help isolate heavily contaminated soil from less-contaminated soil and assist in evaluation of remedial

characterization of source areas is an important and generally necessary part of a typical investigation.

Source area DUs can be identified using various methods, including observation, review of site records, preliminary samples, field analytical samples, area-wide assessments, aerial photographs, interviews and site surveys. Water-soluble pesticides, solvents and light-end petroleum fuels are typical COCs that are highly leachable from soil and pose threats to groundwater and are typically the subject contaminants of source area DUs (ITRC, 2012 Section 3.3 through 3.5).

In contrast to an exposure area DU, a source area DU investigative objective may be to establish that soil concentrations in all samples collected are below a specific threshold rather than comparing the average concentration of the soil samples to that same threshold. The environmental hazard represented by a source may not be best defined by an average exposure. A systematic planning process (see section 5.1) should be used to develop a numeric threshold value and the decision rule for actions to be taken if the threshold is exceeded. The numeric threshold may be a SRL or a groundwater protection level ([GPL- Leaching Guidance reference](#)). Each soil sample concentration is compared to that threshold. Decisions are based on those comparisons (e.g. further excavation or conduct more sampling).

The source area DU in Figure 5.5 depicts a former pesticide mixing operation with known spills and releases. Contaminants include pentachlorophenol, dioxins, furans, and triazine pesticides. Environmental hazards posed by these contaminants include direct exposure, leaching, and contamination of groundwater. The CSM in Figure 5.5 indicates that contamination extends from the ground surface downward to a relatively shallow depth that can easily be reached with a backhoe. Therefore, excavation provides easy access to the desired sample depth. Please note that it is assumed that the lateral boundaries of the source area have already been determined.

5.2.2 Background Sampling

“Background” is a widely used term. Two definitions of background are commonly used:

- 1) Naturally occurring ambient levels of substances in the environment that have not been influenced by humans (e.g. metals that are found in soils);
- 2) Anthropogenic levels of substances in the environment due to human-generated, non-site related sources (e.g., lead in soil along a roadway, benzene in ambient air as a result of a city’s motor vehicle traffic, radiation in sediments that resulted from fallout from past use and testing of nuclear weapons).

A.A.C. R18-7-201 states “Background” means a concentration of a naturally occurring contaminant in soils. A.A.C. R18-7-204 states that a person who conducts remediation to a background concentration for a contaminant shall establish the background concentration using all of the following factors:

- 1) Site-specific historical information concerning land use;
- 2) Site-specific sampling of soils unaffected by a release but having characteristics similar to those of the soils affected by the release; and
- 3) Statistical analysis of background concentrations using the 95th percentile upper confidence limit.

Just because a sampling study indicates that environmental contamination exists, that generally does not indicate where the contaminants came from. Ultimately, an evaluation of the public health implications of exposure to measured or predicted levels of contamination will be needed, regardless of whether chemicals are naturally occurring or result from anthropogenic activities. Yet understanding the contributions from “background” concentrations is an important element of a site-specific analysis. In some cases, contaminants cannot be attributed exclusively to a particular site (e.g., “part of the arsenic in residential soil downwind from the smelter is naturally occurring”); in others, contaminant can be attributed primarily to a given source (e.g., “PCBs are not naturally occurring compounds, and the levels observed in the fish are believed to originate predominantly from the capacitor manufacturing plant’s discharges”), or multiple sources (e.g., “concentrations of PCE in drinking water downgradient from the commercial/industrial zone may be related to merging plumes from multiple dry cleaning facilities in the area”). It is important to include this perspective during environmental site investigations.

There are general rules for how to interpret environmental sampling data in light of background concentrations:

- 1) When levels of contamination are higher than background, the general conclusion is that some source – either the site being evaluated or some other source – has contaminated the media of concern;
- 2) When valid and representative sampling data are consistent with background concentrations, the typical conclusion is that local sources have not significantly impacted the medial of concern; and
- 3) Finally, when sampling data indicate that levels of contamination are lower than background, there might be a problem. By definition, “background” is the concentration of naturally occurring contaminants in the environment. If samples consistently show concentrations lower than background, then it is possible that the samples are biased low or that the background levels you have selected are biased high. (ATSDR, 2005)

This last scenario emphasizes the need for identifying reliable, representative background data. In general, site-specific background data are preferred for use in public health assessments. When identifying appropriate background data, high-quality data that are most representative of the site should be selected. For instance, when identifying background data for metals in soils you should use soils that have similar physical and geological characteristics as the site soils, such as sandy or loamy and should be upstream or upwind from known sources.

Many metals are present in Arizona soils at low concentrations. Arsenic, in particular, often exceeds the Arizona SRL of 10 mg/kg in native soils. The third factor listed in A.A.C. R18-7-204 (see second paragraph of this section for the listed factors in R18-7-204) will result in a conservatively large estimate of the background concentration, that is, there is only a 5% chance that resampling of the area would produce, by chance alone, an average higher than the calculated value. The regulation does not detail a statistical procedure to compare site background data to site data from potentially impacted areas, which may be necessary to determine whether a contaminant has been released. Such a comparison requires careful consideration of project DQOs for hypothesis testing, selection of an appropriate statistical procedure, and Null hypothesis. Also, there are qualitative methods involving geotechnical analysis for evaluating background versus anthropogenic influences. Guidance for comparing background chemical concentrations to investigation area chemical concentrations in soil is given in the documents listed below:

- 1) EPA September 2002 ([540-R-01-003 OSWER 9285.7-41](#)): Guidance for Comparing Background and Chemical Concentrations in Soil for CERCLA Sites
- 2) ASTM D7048-04: Standard Guide for Applying Statistical Methods for Assessment and Corrective Action Environmental Monitoring Programs
- 3) Myers, J and K. Thorbjornsen March 18, 2013: Geochemical Evaluations of Metals in Environmental Media: How to Distinguish Naturally Elevated Concentrations from Site-Related Contamination.

5.2.3 Hot Spots

Hot spots are generally defined as contaminant concentrations of unknown location and area which are much greater than the surrounding soil. Hot spot areas differ from source area DUs in that their locations are unknown and they differ from exposure area DUs in that the hot spot area is not defined by risk assessment considerations. A sampling objective which involves the identification of hot spots is generally not recommended because of the challenges present in determining a size for a DU. Software such as Visual Sampling Plan employ algorithms for calculating the number of samples needed based upon assumed dimensions of the hot spot; however, an impractical number of samples are often required to even identify hot spot areas of relatively large dimensions within a small area. Please see [ITRC 2012](#) Section 3.5 for more information on hot spots.

5.2.4 Incremental Sampling Method

Incremental sampling is a methodology for collecting numerous soil solid samples over the decision unit and then compositing the subsamples into a single sample for laboratory analysis. The technique significantly reduces the large variation between samples that is

often seen when collecting discrete soil samples. Because of the compositing process, only a single sample is usually available and this will not allow a UCL to be calculated. However, the ITRC guidance describes methodologies for calculating 95% UCL with incremental sampling methods. More information regarding incremental sampling can be found at [ITRCs February 2012 Technical and Regulatory Guidance – Incremental Sampling Methodology](#).

5.2.5 Soil Vapor Sampling

If the COC is volatile, soil vapor sampling is an effective method of estimating inhalation exposure and locating sources. The number of soil vapor samples needed to estimate inhalation exposure concentrations in a decision unit is based on exposure and characterization considerations.

Also, A.A.C. R18-7-203(C) states a soil vapor concentration may be used to estimate the total contaminant concentration in soil if the Department determines that the soil vapor concentration methodology will not be invalidated by the soil, hydrogeology, or other characteristics of the site. Section 6.2.3.1 of this guidance manual discusses soil vapor concentration conversions to soil solid concentrations. This conversion is often used to compare site-specific soil vapor data to SRLs and GPLs, which are listed as soil solid concentrations. The [GPL Spreadsheet](#) includes a tab with a partitioning equation to conduct the conversion.

5.2.6 Confidence limits

Confidence limits are the lower and upper boundaries/values of a confidence interval, that is, the values which define the range of a confidence interval. The upper and lower bounds of a 95% confidence interval are the 95% confidence limits.

5.2.7 Chemical Analysis of Soil, Groundwater and Soil Vapor (Table)

Table 5.3 lists the classes of analytes that are typically of the greatest interest during site investigations, as well as the ADEQ's preferred analytical methods. This table provides a starting point for selecting analytical methods for site investigations. Additional methods may be available and appropriate; consult with the appropriate ADEQ Program or [Exhibit 1 of Title 9, Chapter 14, Article 6](#) that details Arizona Administrative Code for the Arizona Department of Health Services for alternate methods.

Table 5.3 Recommended Analysis Methods for Soil, Groundwater and Soil Vapor Samples
 Common Contaminants at Project Sites

Laboratory Analytical Methods for Investigations			
Test Method →	EPA Method 8260B	EPA Method 8310 or 8270 SIM	EPA Methods 6000 and 7000. See Footnote 3
Products			
VOCs ^{1,2}	X		
SVOCs		X	
Metals			X
Organochlorine Pesticides	EPA Method 8081A		

Footnotes:

1. A soil vapor concentration may be used to estimate the total contaminant concentration in soil if the Department determines that the soil vapor concentration methodology will not be invalidated by the soil, hydrogeology, or other characteristics of the site. The analytical method should be TO-15.
2. VOCs are to be analyzed using the current EPA Method 8260B (full list). For UST systems in place during 1996 or before, EPA Method 504.1 should be used to investigate for the presence of EDB (water only).
3. Make a due diligent effort to obtain the background levels of the metals analyzed for comparison purposes.

Abbreviations: VOC = volatile organic compounds; SVOCs = semi-volatile organic compounds

Please note that when requesting compound specific analyses and the sample is petroleum based, the laboratory should be informed as such.

Please note that Appendix 1 of Title 9 (Health Services), Chapter 14 (Department of Health Services Laboratory) in the Arizona Administrative Code contains a listing of ADHS approved methods for several analytes in different mediums.

5.2.7.1 Additional Chemical Data Requirements for LUST Releases

Petroleum release (soil and groundwater):

The compounds listed in the Table 5.4 need to be included on the target compound list for EPA Method 8260B to evaluate regulated compounds typically present in petroleum fuel releases. If any of the compounds listed in the table can't be run by the standard or extended 8260B list by a particular laboratory, have the laboratory report the compounds as a TIC (tentatively identified compound). All other standard 8260B target compounds still need to be reported along with this target compound list. For samples requiring dilution, the laboratory needs to provide the lowest reporting level achievable. If the compound is present below the lowest practical reporting level but above the method reporting limit, the laboratory should report the concentration as estimated with the

appropriate Arizona Data Qualifier. This does not negate use of the data. Soil samples should be field methanol preserved using laboratory provided aliquot devices and pre-weighed methanol VOA vials **OR** subsampled using an En Core®, Terra Core™ or equivalent per EPA Method 5035 and ADEQ’s substantive policy 0170.

Table 5.4 Chemicals to be included on target compound list

1,3-Butadiene	Benzene
n-butyl benzene	Toluene
Sec-butyl benzene	Ethyl benzene
Tert-butyl benzene	Xylenes
Carbon disulfide	1,2,4-Trimethylbenzene
Cumene (Isopropyl benzene)	1,3,5-Trimethylbenzene
Cyclohexane	MTBE (methyl tert butyl ether)
4-ethyltoluene	EDB (1,2-dibromoethane/ ethylene dibromide)
Methyl cyclohexane	1,2-DCA (1,2-dichloroethane)
Naphthalene	Dicyclopentadiene
n-propylbenzene	n-Hexane
Propylene (Propene)	p-isopropyl toluene

Former leaded gasoline or current aviation gasoline releases:

EDB analysis in groundwater (source well) need to be analyzed by EPA Method 504.1 or 524.3 whichever method that laboratory has ADHS certification for, and the method should reach a reporting level of 0.05 µg/L (which is the AWQS). Soil samples should be analyzed by EPA Method 8011 in order to reach a reporting level of 0.29 mg/Kg unless the analytical equipment used for EPA Method 8260B has a low enough reporting level.

Tetra-ethyl lead (organic lead) chemical analysis is necessary at LUST sites that historically sold or used leaded gasoline. Leaded gasoline was, for the most part, phased out of use in the U.S. by 1995. Leaded aviation gasoline and leaded racing fuel is still being used in the U.S. **The only laboratory found so far that can meet the reporting limit of 0.0061 mg/Kg (the residential SRL) is McCampbell Analytical in California.** McCampbell uses their in-house method, which is appropriate instead of the California method HML939-M.

Fuel releases other than jet fuel and gasoline (waste oil etc):

Samples should be analyzed for polycyclic aromatic hydrocarbons (PAHs) using EPA Method 8310 **OR** Method 8270SIM (not 8270C) as long as the reporting level of 0.69 mg/kg for soils and 0.05 µg/L for groundwater is achieved.

The laboratory performing the analyses must be certified by ADHS for the method (AAC R18-12-280(A)).

Important Information You Should Know after Reading Section 6.1 – Soil Sampling:

1. [Grain size descriptions and some field tests of unconsolidated materials.](#)
2. [Primary fate and transport mechanisms for contaminants in soil.](#)
3. [The different soil sampling techniques.](#)
4. [Some soil sampling strategies for investigating direct contact exposure scenarios.](#)

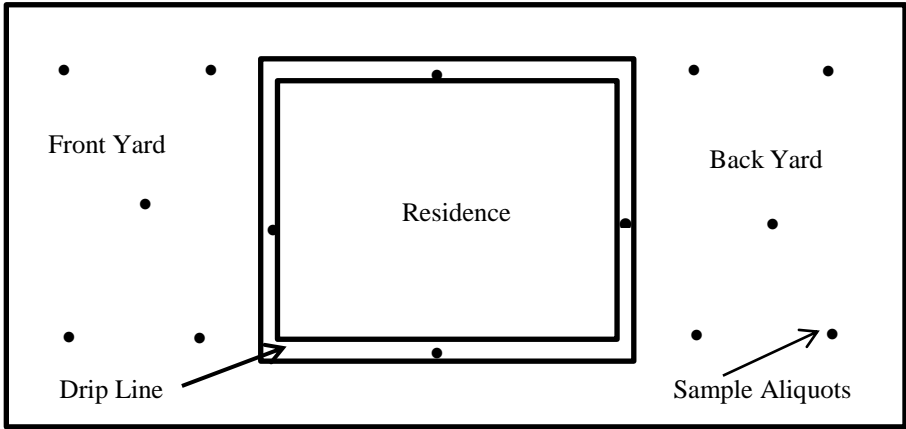
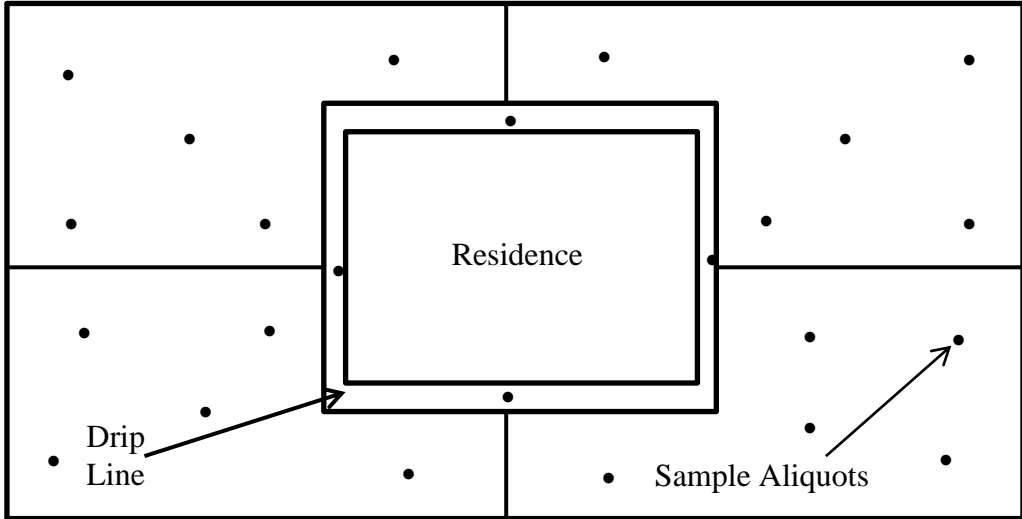
<p>Grain size descriptions and field tests for soil:</p> <ol style="list-style-type: none"> 1. The Unified Soil Classification System (USCS) is a soil classification system that is used to describe texture and grain size of soils. Gravel, sand, silt, clay and organics are the main classifications of unconsolidated soils. 2. Soil moisture, relative density (for coarse grained soils) and consistency (for fine grained soils) are other soil descriptors that help classify soils and assist in developing a contaminant fate and transport CSM. 	<p>Primary fate and transport mechanisms:</p> <ol style="list-style-type: none"> 1. Volatilization – The Henry’s Law Constant of a chemical quantifies the degree of volatility for that chemical. The amount of volatilization of a chemical in soil that ultimately discharges into the atmosphere results in a reduction of chemical concentration in soil over time. 2. Chemical Degradation – biotic (biologically based) and abiotic (non-biologically based). <ol style="list-style-type: none"> a. During biodegradation (biotic process), naturally occurring subsurface microorganisms transform a chemical to another state. Biodegradation reactions often break down organic chemicals to less toxic forms. b. Abiotic reactions include photodegradation and hydrolysis. <ol style="list-style-type: none"> i. Photodegradation - decomposition of a chemical from exposure to radiant energy (e.g. sunlight). ii. Hydrolysis - the degradation reaction of the chemical with components of water (e.g., hydroxyl and hydronium ions). 3. Erosion – physical processes such as high winds and runoff from precipitation events can scour soil surface particles and deposit them downstream, causing a redistribution of any contaminant adsorped to the soil particle. 4. Leaching - a measure of the ability of a chemical to migrate to greater depths with infiltrating water. Leaching is largely a function of a chemical’s solubility and particle affinity 5. Water solubility – this describes the amount of a chemical that will dissolve in a given quantity of water. 6. Adsorption – the ability of a substance to bind to the surface of soil particles as a result of reactions that occur between the chemical and soil particle surface
<p>Soil sampling techniques:</p> <p>Penetrating Probe Sampler Split Barrel Sampler Thin-Walled Tube Miniature Core Sampler Modified Syringe Sampler</p> <p>Each sampling technique has its advantages and limitations. For example:</p>  <p>A hand auger is easy to use and relatively quick for shallow subsurface samples, but sampling is limited to a depth of about 20 feet below surface.</p>	<p>Strategies for investigating direct contact exposure scenarios:</p> <p>Recommended Minimum Soil Sampling in yards less than or equal to 5,000 square feet with small side yard:</p>  <p>Recommended Minimum Soil Sampling in yards greater than 5,000 square feet:</p> 

Section 6.0 Soils, Soil Vapor and Groundwater

6.1 Soil Sampling

A.A.C. R18-7-201 defines soil as all earthen materials, including moisture and pore space contained within earthen material located between the land surface and groundwater including sediments and unconsolidated accumulations produced by the physical and chemical disintegration of rocks.

A.A.C. R18-12-101 defines surficial soil as any soil occurring between the current surface elevation and extending to that depth for which reasonably foreseeable construction activities may excavate and relocate soils to surface elevation, and any stockpiles from soils of any depth.

Investigation for the extent and distribution of soil contamination is required for regulated substances that impact soil. A soil investigation should be conducted if data, compiled in the continuous development of the CSM, suggests that the soil (and/or groundwater) is or may potentially be impacted.

6.1.1 Unified Soil Classification System and Other Soil Descriptions

The Unified Soil Classification System (USCS – Table 5.1) is a [soil classification](#) system should be utilized to describe the texture and grain size of a soil in all remedial investigations. The classification system can be applied to most [unconsolidated](#) materials, and is represented by a two-letter symbol. Each letter is described below (with the exception of **Pt**):

First and/or second letters

Letter	Definition
G	gravel
S	sand
M	silt
C	clay
O	organic

Second letter

Letter	Definition
P	poorly graded (uniform particle sizes)
W	well-graded (diversified particle sizes)
H	high plasticity
L	low plasticity

If the soil has 5–12% by weight of fines passing a #200 sieve ($5\% < P\#200 < 12\%$), both grain size distribution and plasticity have a significant effect on the engineering properties of the soil, and dual notation may be used for the group symbol. For example, GW-GM corresponds to "well-graded gravel *with silt*."

If the soil has more than 15% by weight retained on a #4 sieve ($R_{\#4} > 15\%$), there is a significant amount of gravel, and the suffix "with gravel" may be added to the group name, but the group symbol does not change. For example, SP-SM could refer to "poorly graded sand with silt" or "poorly graded SAND with silt and gravel."

Table 6.1 USCS Symbol chart

Major divisions		Group symbol	Group name	
Coarse grained soils more than 50% retained on No. 200 (0.075 mm) sieve	gravel (.19 inches to 2.9 inches) > 50% of coarse fraction retained on No. 4 sieve	clean gravel <5% smaller than No. 200 Sieve	GW well-graded gravel, fine to coarse gravel	
			GP poorly graded gravel	
		gravel with >12% fines	GM silty gravel	
			GC clayey gravel	
	sand (.003 inches to .19 inches in size) $\geq 50\%$ of coarse fraction passes No. 4 sieve	clean sand	SW well-graded sand, fine to coarse sand	
			SP poorly graded sand	
		sand with >12% fines	SM silty sand	
			SC clayey sand	
Fine grained soils more than 50% passes No. 200 sieve	silt and clay liquid limit < 50 (<.003 inches)		ML silt	
		inorganic	CL clay of low plasticity, lean clay	
		organic	OL organic silt, organic clay	
	silt and clay liquid limit ≥ 50	Inorganic		MH silt of high plasticity , elastic silt
				CH clay of high plasticity, fat clay
		organic	OH organic clay, organic silt	
Highly organic soils		Pt	peat	

Tables 6.2, 6.3 and 6.4 contain other soil descriptions that should be included on a boring log.

Table 6.2 Soil Moisture Descriptions

Criteria for Describing Moisture Conditions of Collected Soil Samples	
Description	Criteria
Dry	Absence of moisture, dusty, dry to touch
Moist	Damp, but no visible water
Wet	Visible free water, soil is usually below water table

Table 6.3 Relative Density Field Tests

Relative Density of Coarse Grained Soils (developed from Sowers, 1979)		
Blows/ft	Relative Density	Field Test
0-4	Very loose	Easily penetrated by 1/2 inch steel rod pushed by hand
5-10	Loose	Easily penetrated by 1/2 inch steel rod pushed by hand
11-30	Medium	Easily penetrated by 1/2 inch steel rod driven by 5 pound hammer
31-50	Dense	Penetrated a foot by 1/2 inch steel rod driven by 5 pound hammer
>50	Very Dense	Penetrated only a few inches by 1/2 inch steel rod driven by 5 pound hammer

Table 6.4 Consistency Tests

Consistency of Fine Grained Soils (developed from Sowers, 1979)				
Blows/ft	Consistency	<u>Pocket Penetrometer</u>	<u>Torvane</u>	Field Test
<2	Very soft	<0.25	<0.12	Easily penetrated several inches by fist
2-4	Soft	0.25-0.50	0.12-0.25	Easily penetrated several inches by thumb
5-8	Firm	0.50-1.0	0.25-0.50	Can be penetrated several inches by thumb with moderate effort
9-15	Stiff	1.0-2.0	0.50-1.0	Readily indented by thumb, but penetrated only with great effort
16-30	Very stiff	2.0-4.0	1.0-2.0	Readily indented by thumbnail
>30	Hard	>4.0	>2.0	Indented with difficulty by thumbnail

Figure 6.1 is an example of a typical soil boring log produced from data collected in the field. There are, though, several variations of the boring log and the information contained on the boring log can be dependent upon project objectives. The purpose of the boring log, though, is to convey as much information as possible about the subsurface conditions so that the CSM will be accurate as possible.

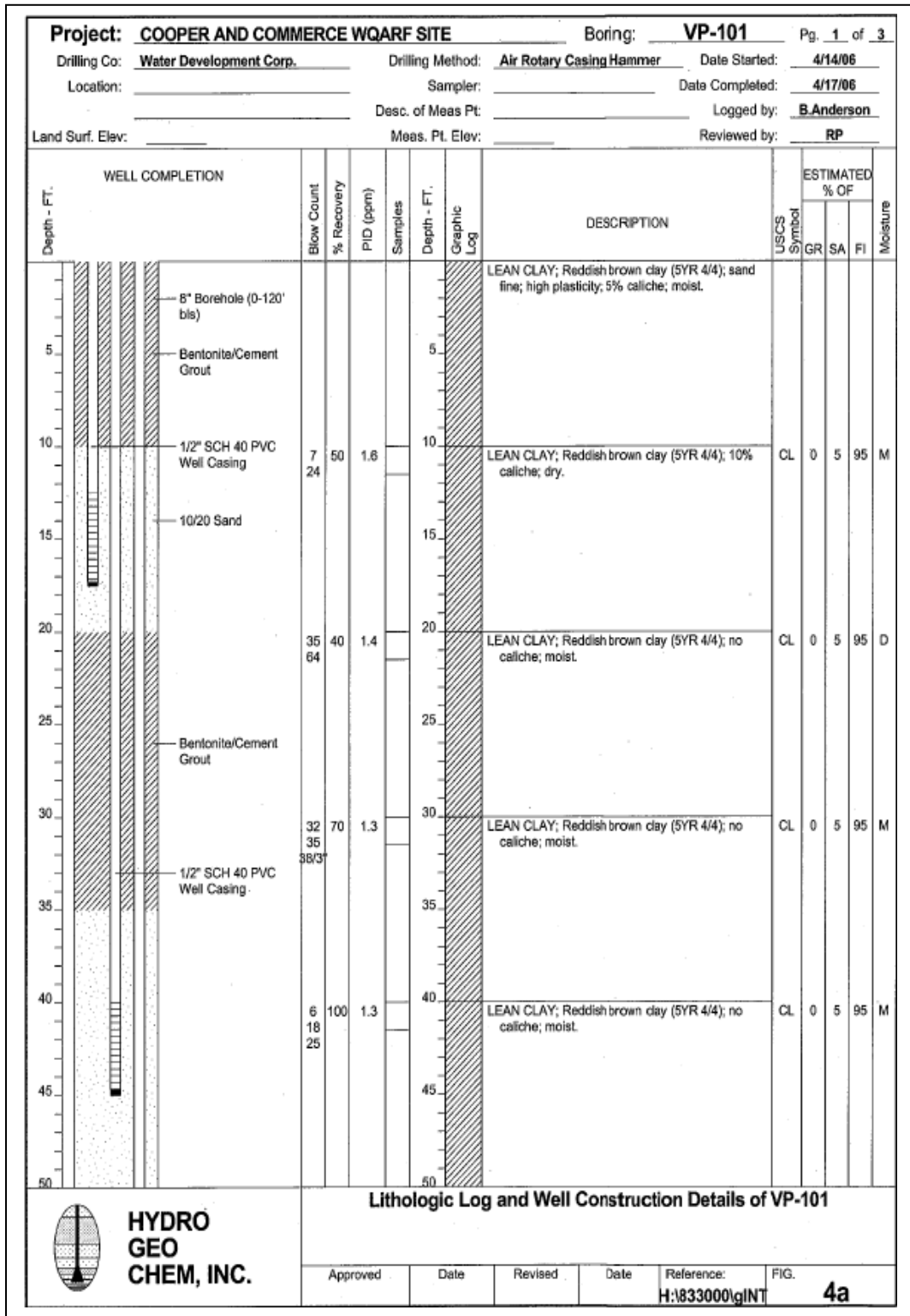

Figure 6.1 Typical Soil Boring Log

6.1.2 Soil Contaminant Fate and Transport

The movement of contaminants through the subsurface is complex and is difficult to predict. Different types of contaminants react differently with soils, sediments, and other geologic materials and commonly travel along different flowpaths and at different velocities. One of the challenges for investigators is to obtain meaningful chemical data from water samples collected from observation wells and monitoring wells to use to map the distribution of specific contaminants and to use as targets for any models that may be constructed to predict forward or backward in time.

Most contaminants are introduced to the subsurface by percolation through soils. The interactions between a soil and a contaminant are important for assessing the fate and transport of the contaminant in the groundwater flow system. Contaminants that are highly soluble, such as salts (e.g. sodium chloride, NaCl) move readily from surface soils to saturated materials below the water table. This often occurs during and after rainfall events. Those contaminants that are not highly soluble may have considerably longer residence times in the soil zone. Other contaminants, such as VOCs, can move relatively quickly through the vadose zone through volatilization in response to concentration gradients and advective movement in response to pressure changes.

6.1.2.1 Primary Fate and Transport Mechanisms in Soil

Primary fate and transport mechanisms for contaminants include the following:

- Volatilization of chemicals from soil;
- Degradation of chemicals in soil;
- Erosion of particulate-bound chemicals from soil; and
- Leaching from soil with infiltrating water
- NAPL migration through the subsurface

Volatilization

Volatilization can significantly affect the distribution of a VOC in the environment. Near the soil surface, mass may be lost to the atmosphere by volatilization. For deeper soils, volatilization will redistribute mass from high concentration areas to lower concentration areas. The process is illustrated in the Figure 6.11 which shows the theoretical concentration change over time at 20 meters depth in a vadose zone that was initially contaminated with TCE to 10 meters. Over time, the concentration at 20 meters depth increases as volatilization transports mass deeper into the vadose zone. Concentrations are then reduced over time as infiltration and further volatilization reduce concentrations.

Chemical volatility is typically quantified by a chemical's [Henry's Law constant](#). Henry's Law constant may be calculated from the chemical's vapor pressure, molecular weight, and solubility. The lower the Henry's Law constant, the less volatile the chemical. Values of Henry's Law constant some COCs are summarized in Table 6.5.

Degradation

Numerous chemicals in the environment are subject to naturally occurring biotic (biologically based) and abiotic (non-biologically based) transformation reactions that result in the degradation of the chemical. Many organic compounds are subject to biodegradation reactions under aerobic (in the presence of oxygen) and anaerobic (in the absence of oxygen) conditions. During biodegradation, naturally occurring microorganisms in the subsurface transform a chemical to another state as a direct or indirect consequence of their metabolic processes. Biodegradation reactions often break down organic chemicals to less toxic forms; however, incomplete degradation can produce more toxic byproducts such as vinyl chloride during anaerobic degradation of TCE and PCE.

Several naturally occurring abiotic reactions can significantly affect the fate of chemicals in the environment. Common abiotic reactions include photodegradation and hydrolysis. Photodegradation is the process of decomposition of a chemical upon exposure to radiant energy such as the action of light, and is most significant to chemicals in surface soil that are in direct contact with sunlight. Hydrolysis is the degradation reaction of the chemical with components of water (e.g., hydroxyl and hydronium ions) and is thus most important in saturated environments.

Pesticides, PCBs, and SVOCs have some potential to degrade in response to abiotic and/or biotic processes; however, the effects of degradation on the fate of these compounds are unlikely to be significant over the near-term. Metals typically are not reduced in concentration in degradation reactions but may undergo changes in oxidation state which can affect their solubility and/or toxicity. Petroleum hydrocarbons are known to be biodegraded, particularly under aerobic conditions.

Erosion Processes

Erosion processes can substantially affect the distribution of soil-bound particulates in the environment and thus influence the distribution of soil contaminants. High winds can scour fine particles from the soil surface and redistribute these particles downwind. Similarly, runoff resulting from heavy precipitation events can scour fine soil particles from surface soils, eventually depositing the particles during sedimentation downstream. These physical processes often represent the primary mechanism for transport of otherwise immobile chemicals such as metals.

Leaching

Chemicals in soil have the potential to migrate to greater depths with infiltrating water. The rate of movement of the chemicals is dependent upon the affinity of the chemical for the soil and the rate of movement of infiltrating water. For simplicity, infiltration is often modeled as a wetting front of constant velocity. However, infiltration is a complex phenomenon and water may move much faster through high permeability zones in the vadose zone, allowing contamination to move deeper and perhaps to groundwater.

Table 6.5 Organic Carbon Partition Coefficient and Dimensionless Henry's Law Constant values for some VOCs

Compound	K _{oc} (L/kg) ¹	H _o (dimensionless) ²
Benzene	145.8	2.27E-01
Bromodichloromethane	31.82	8.67E-02
Bromoform	31.82	2.19E-02
Carbon disulfide	21.73	5.89E-01
Carbon tetrachloride	43.89	1.13E+00
Chlorobenzene	233.9	1.27E-01
Chloroform	31.82	1.50E-01
1,2-Dibromoethane (EDB)	39.6	2.66E-02
1,1-Dichloroethane	31.82	2.30E-01
1,2-Dichloroethane (DCA)	39.6	4.82E-02
1,1-Dichloroethene	31.82	1.07E+00
<i>cis</i> -1,2Dichloroethene	39.6	1.67E-01
<i>Trans</i> -1,2-Dichloroethene	39.6	1.67E-01
1,2-Dichloropropane	60.7	1.15E-01
1,3-Dichloropropene	72.17	1.45E-01
Ethyl benzene	446.1	3.22E-01
Methylene chloride	21.73	1.33E-01
Styrene	446.1	1.12E-01
1,1,2,2-Tetrachloroethane	94.94	1.50E-02
Tetrachloroethene (PCE)	94.94	7.25E-01
Toluene	233.9	2.72E-01
1,1,1-Trichloroethane	43.89	7.03E-01
1,1,2-Trichlorethane	60.7	3.37E-02
Trichloroethene (TCE)	60.7	4.03E-01
1,2,4-Trimethylbenzene	614.3	2.52E-01
1,3,5-Trimethylbenzene	602.1	3.59E-01
Vinyl acetate	5.58	2.10E-02
Vinyl chloride	21.73	1.14E+00
Xylenes (total)	382.9	2.12E-01
Ref: U.S. EPA Region 9 (May 2013). Please visit http://epa.gov/region9/superfund/prg/ for most current values ¹ - K _{oc} = organic carbon partition coefficient ² - H _o = Dimensionless Henry's Law Constant (HLC[atm-m]*41(25°C))		

Solubility

Water solubility describes the amount of a chemical that will dissolve in a given quantity of water (see Table 7.1), and thus is a primary determinant in the transport of a chemical in the environment. Highly soluble chemicals can often readily dissolve in water and are thus susceptible to being mobilized from the soil matrix with infiltrating water and migrate to groundwater. The solubility of organic chemicals is typically a function of the hydrophobic nature of the chemical. Many organic chemicals are [non-polar](#) and thus do not dissolve readily into water—a polar solution. Strongly non-polar compounds, such as [polychlorinated dibenzo-*p*-dioxins](#) (PCDDs) and [dibenzo-*p*-furans](#) (PCDFs), have low water solubility and therefore are rarely present in water.

The solubility of inorganic chemicals is typically a function of the tendency of the chemical to form mineral phases and the relative abundance of the chemical ingredients required to form the mineral phase. The solubility of inorganic COCs (e.g. metals) is highly dependent on solution conditions at a site. Arsenic and chromium will change oxidation states, depending on reduction-oxidation (redox) conditions in groundwater. Arsenic is most commonly present in aqueous environments as As^{3+} or As^{5+} . Both arsenic species are soluble (relative to risk-based levels of concern) under most environmental conditions, and the aqueous concentration of arsenic is unlikely to be controlled by a specific mineral phase. Chromium is most frequently present as Cr^{3+} or Cr^{6+} in the environment. Cr^{6+} is substantially more soluble and mobile than Cr^{3+} , which will readily precipitate as the mineral Cr_2O_3 . As a result, chromium is typically immobile in reducing (i.e., anoxic) environments.

Adsorption

The aqueous concentration of chemicals in soil systems can also be substantially influenced by [adsorption](#) reactions to the soil matrix. Adsorption is the ability of a substance to bind to the surface of soil particles as a result of reactions that occur between the chemical and the soil particle surface. The tendency for a chemical to be adsorbed is a function of the nature of the chemical and the site-specific soil properties, and is typically quantified by a [distribution coefficient](#) (K_d). A K_d is a measure of the ratio of chemical mass that partitions to the solid and liquid phases under equilibrium conditions.

Inorganic compounds are commonly bound to soil particles as a result of electrostatic interactions. The mineral hydrous ferric oxide (FeOOH) is a dominant sorbent for many inorganic compounds in natural systems, owing to its common presence on soil particle surfaces, high surface area, and [amphoteric](#) character. As a result, the site-specific K_d for inorganic compounds is often correlated to the concentration of hydrous ferric oxide in the soil matrix.

Organic compounds are frequently non-polar and thus tend to interact with organic matter commonly associated with the soil matrix. The general tendency of an organic chemical to be adsorbed by soils may be assessed by the chemical's [organic carbon partition coefficient](#) (K_{oc}), which describes the tendency of the chemical to partition from water to organic carbon. The site-specific K_d for organic chemicals can be estimated as the product of the fraction of organic carbon (f_{oc}) in the soil matrix and the chemical's K_{oc} .

However, K_d values for inorganic compounds may be quite variable and do not necessarily correlate with organic carbon such as for organic chemicals. Often, site specific soil information is needed to estimate an inorganic K_d .

6.1.2.2 NAPL Migration in unsaturated zone

Soil texture and [viscosity](#) play important roles in how chemicals migrate through the unsaturated zone. The key concepts of NAPL migration in the unsaturated zone is as follows:

- LNAPL and DNAPL migration through unconsolidated deposits such as sands, silts, and gravels is influenced primarily by geological structure.
- Lateral flow and pooling of NAPL can occur in response to even subtle variations in permeability and geological structure.
- Finding individual NAPL pools and zones of residual at a site often is not practicable. Remediation efforts need to be applied over larger volumes of the subsurface within which pools and zones of residual exist.
- Although it is commonly thought that LNAPL "floats" on the water table, this is incorrect. Significant portions of LNAPL may have migrated below the water table during the initial migration process and also in response to water table fluctuations.
- Because the bulk retention capacity of fractured media is low, even small volumes of NAPL can migrate significant lateral and vertical distances in fractured rock and clay.

Following release at the ground surface, a NAPL will migrate down through the unsaturated zone, distributing itself both as residual and in pools. NAPLs typically will imbibe into dry, finer-grained layers and will flow laterally along any high-water-content layers not exhibiting continuous air pathways (i.e. NAPLs are wetting with respect to air and non-wetting with respect to water). Therefore, NAPL in the unsaturated zone typically exist at negative pressure (i.e. tends to stay put in the tighter pore spaces) and will not flow into an open borehole or excavation.

Once present in unsaturated media, residual and pooled NAPL may vaporize, giving rise to vapor plumes. In dry and warm environments, vaporization may deplete all residual and pooled NAPL in as short as a few years, depending on the vapor pressure of the particular NAPL. In such cases, however, the vapor phase, aqueous phase, and sorbed phase contamination may persist for several years or decades.

LNAPL migration through the unsaturated zone is similar to DNAPL migration, except in the vicinity of the water table. Because LNAPL is less dense than water, significant pooling can occur. It is important to note, however, that LNAPL does not "float" on the

water table. Detailed examination of the distribution of LNAPL in the vicinity of the water table will show that the lower portion of the LNAPL pool is at positive pressure and exists below the water table. At some location in the LNAPL pool, the LNAPL table exists, with LNAPL at negative pressure above this surface. Only LNAPL at positive pressure is recoverable using skimmer pumps in monitoring wells. The LNAPL at negative pressure, although representing a continuous and potentially mobile phase, will not flow into an open borehole or monitoring well.

Continuous and One-Time Spills

The temporal/spatial nature and volume of a release will affect NAPL movement and distribution of the contaminants in the subsurface. The following are some of the situations that may occur at a site with a NAPL release to the environment:

1. Continuous release - such as from a small leak in a chemical pipeline or from an area where chemicals are manually transferred between storage containers.

The flow of NAPL is likely limited to one or a few vertical flowpaths.

2. Series of smaller discrete spills in different locations – such as leaks from compromised 55 gallon drums or releases to the environment due to sloppy storage and disposal practices.

The flow of NAPL is likely to result in flow along many different flowpaths, dependent, in part, on the lithology encountered.

3. Discrete spills at different times in the same location - such as punctures near the top of a UST that is consistently refilled when near empty.

NAPL will migrate in the subsurface in response to the initial release. If another release occurs at the same location, it is likely that the NAPL will migrate differently than earlier releases due to the changed subsurface conditions caused by the initial release. Each separate release may cause the subsurface NAPL distribution to be more complex.

Please note that when there are separate small releases, the driving force for NAPL migration is likely to be less than a long-term or continuous release (see explanation below).

In an isolated release, the NAPL phase will become “trapped” in pore spaces relatively quickly if a small, finite amount of NAPL is released (Figure 6.2). As the mass of NAPL moves through the subsurface and more of the NAPL is trapped in pore spaces, the driving forces (i.e. gravity and positive pressure) for continued NAPL movement are depleted.

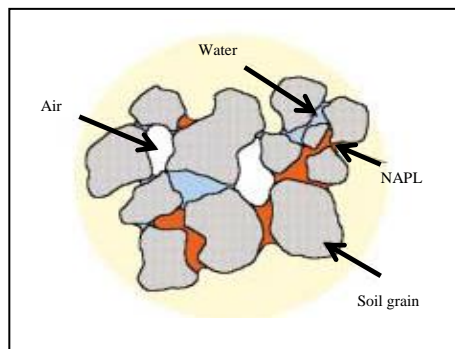

**Figure 6.2 Depiction of
“trapped” NAPL Phase**

In contrast, a continuous release of NAPL (depending on wettability) fills the contiguous pore spaces in the subsurface matrix and flows through the pore spaces as a continuous body and does not become “trapped” in pore spaces until the release has ceased. The continuous release will maintain a constant flow of NAPL that will maintain relatively constant conditions in the subsurface. In this case, once the NAPL interacts with the formation and displaces the original pore fluid, flow is likely to continue along the same pathway formed by the leading edge of the NAPL.

If the releases or successive releases occur over time, the characteristics of the NAPL itself could change, which can result in altered flow potential. Some examples of changes that can occur at a release area are:

1. Manufacturing processes change resulting in a change in NAPL composition; and
2. Specific gravity of the NAPL can change over time due to weathering (i.e., preferential dissolution or other mechanisms. This is a phenomenon observed at some creosote and manufactured gas plant sites.

Detailed discussions of the relationship between release history and NAPL migration and flow patterns are available in [Cohen and Mercer](#) (1993). Table 6.6 includes some of the suggestive indications of NAPL presence based on the examination of sub surface samples and data.

Table 6.6 Determinant, Inferential, and Suggestive Indications of DNAPL Presence
 based on examination of subsurface samples and data (based on Newell and Ross, 1992; Cherry and Feenstra, 1991; and Cohen et al, 1992) (Cohen and Mercer, 1993)

DETERMINING DNAPL PRESENCE BY VISUAL EXAMINATION OF SUBSURFACE SAMPLES	INFERRING DNAPL PRESENCE BY INTERPRETING CHEMICAL ANALYSES	SUSPECTING DNAPL PRESENCE BASED N ANOMALUS FIELD CONDITIONS
<p>Methods to detect DNAPL in wells:</p> <ul style="list-style-type: none"> ● NAPL/water interface probe detection of immiscible phase at vase of fluid column ● Pumping from bottom of fluid column and inspecting retrieved sample ● Retrieving a transparent, bottom-loading bailer from the bottom of a well and inspecting the fluid sample ● Inspecting fluid retrieved from the bottom of a well and inspecting the fluid sample ● Inspecting fluid retrieved from the bottom of a well using a mechanical discrete-depth sampler ● Inspecting fluid retained on a weighted cotton string that was lowered down a well <p>Methods to enhance Inspection of fluid samples for DNAPL presence:</p> <ul style="list-style-type: none"> ● Centrifuge sample and look for phase separation ● Add hydrophobic dye (such as Sudan IV or Red Oil) to sample, shake, and look for coloration of DNAPL fraction ● Examine UV fluorescence of sample (many DNAPLs will fluoresce) ● Assess density of NAPL relative to water (sinkers or floaters) by shaking solution or by using a syringe needle to inject NAPL globules into the water column <p>Methods to detect DNAPL in soil and rock samples:</p> <ul style="list-style-type: none"> ● Examine UV fluorescence of sample (many DNAPLs will fluoresce) ● Add hydrophobic dye and water to soil sample in polybag r jar, shake, and examine for coloration of the NAPL fraction ● Conduct a soil-water shake test without hydrophobic dye (can be effective for NAPLs that are neither colorless nor the color of the soil) ● Centrifuge sample with water and look for phase separation ● Perform a paint filter test, in which soil is placed in a filter funnel, water is added, and the filter is examined for separate phases 	<p>Chemical analysis results from which DNAPL presence can be inferred (with more or less certainty depending on the strength of the overall data):</p> <ul style="list-style-type: none"> ● Concentrations of DNAPL chemicals in groundwater are greater than 1% of the pure phase solubility or effective solubility ● Concentrations of DNAPL chemicals on soils are greater than 10,000 mg/kg (equal to 1% soil mass) ● Concentrations of DNAPL chemicals in groundwater calculated from water/soil partitioning relationships and soil samples are greater than pure phase solubility or effective solubility ● Organic vapor concentrations detected in soil gas exceeds 100 – 1000 ppm 	<p>Field conditions that suggest DNAPL presence:</p> <ul style="list-style-type: none"> ● Concentrations of DNAPL chemicals increase up the hydraulic gradient from the contaminant release area (apparently due to contaminated soil gas migration and/or, DNAPL movement along capillary and/or permeability interfaces that slope counter to the hydraulic gradient) ● Erratic patterns of dissolved concentrations of DNAPL chemicals in groundwater which are typical of DNAPL sites due to heterogeneity of (1) the DNAPL distribution, (2) the porous media, (3) well construction details, and (4) sampling protocols ● Erratic, localized, very high contaminant concentrations in soil gas, particularly located just above the water table (where dense gas derived from DNAPL in the vadose zone will tend to accumulate) ● Dissolved DNAPL chemical concentrations in recovered groundwater that decrease with time during a pump-and-treat operation, but then increase significantly after the pumps are turned off (although complexities of contaminant desorption, formation heterogeneity, and temporal and spatial variations of the contaminant source strength can produce similar results) ● The presence of dissolved DNAPL chemicals in groundwater that is older than potential contaminant releases (using tritium analysis for age dating) suggests DNAPL migration (Uhlman, 1992) ● Deterioration of wells and pumps (can be caused by DNAPL; i.e., chlorinated solvents degrade PVC)

6.1.3 Soil Sampling Techniques

Much of the information in this section was drawn from ASTM standards. In particular, much of the information came from ASTM D 6232, Standard Guide for Selection of Sampling Equipment for Waste and Contaminated Media Data Collection Activities.

Push Coring Devices:

Push coring devices include equipment that utilizes a pushing action to collect a vertical column of a solid sample. Summaries provided in this section of this guidance manual are for the following push coring devices:

Penetrating Probe Sampler
Thin-Walled Tube
Modified Syringe Sampler

Split Barrel Sampler
Miniature Core Sampler

Penetrating Probe Sampler

The penetrating probe sampler (Figure 6.3) is a push coring device and, therefore, provides a core sample. The probe sampler is recommended for sampling soil and other solids. The sample volume range is 0.2 to 2.0 liters (ASTM D 6232). The probe sampler typically consists of single or multiple threaded steel tubes, a threaded top cap, and a detachable steel tip. The steel tubes are approximately 2 inches or less in diameter. Specialized attachments may be used for various matrices. Some probes are equipped with adjustable screens or retractable inner rods to sample soil vapor or groundwater.

A penetrating probe type sampler is also available with a valve. The valve is a retaining device to hold the sample in place as the coring device is removed. This type of push coring device is recommended for wet soil, and can also be used to sample unconsolidated solid waste, mixed-phase solid/liquid waste, and free-flowing powders. The coring device may be used in drums and small containers as well as tanks, lagoons, and waste impoundments. The sample volume range is 0.2 to 1.5 liters (ASTM D 6232).

Advantages

- Easy to decontaminate and is reusable.
- Can provide samples for onsite analysis (ASTM D 6232).
- Versatile and may sample 15 to 20 locations a day for any combination of matrices (ASTM D 6232).
- Can reduce quantity of investigative derived wastes.

Limitations

- May be heavy and bulky depending on the size used.
- Limited by composition of subsurface materials and accessibility to deeper depth materials.
- May be inappropriate for sampling materials that require mechanical strength to penetrate.
- May be appropriate for VOCs only if a liner is used and samples are extracted as required by Method 5035

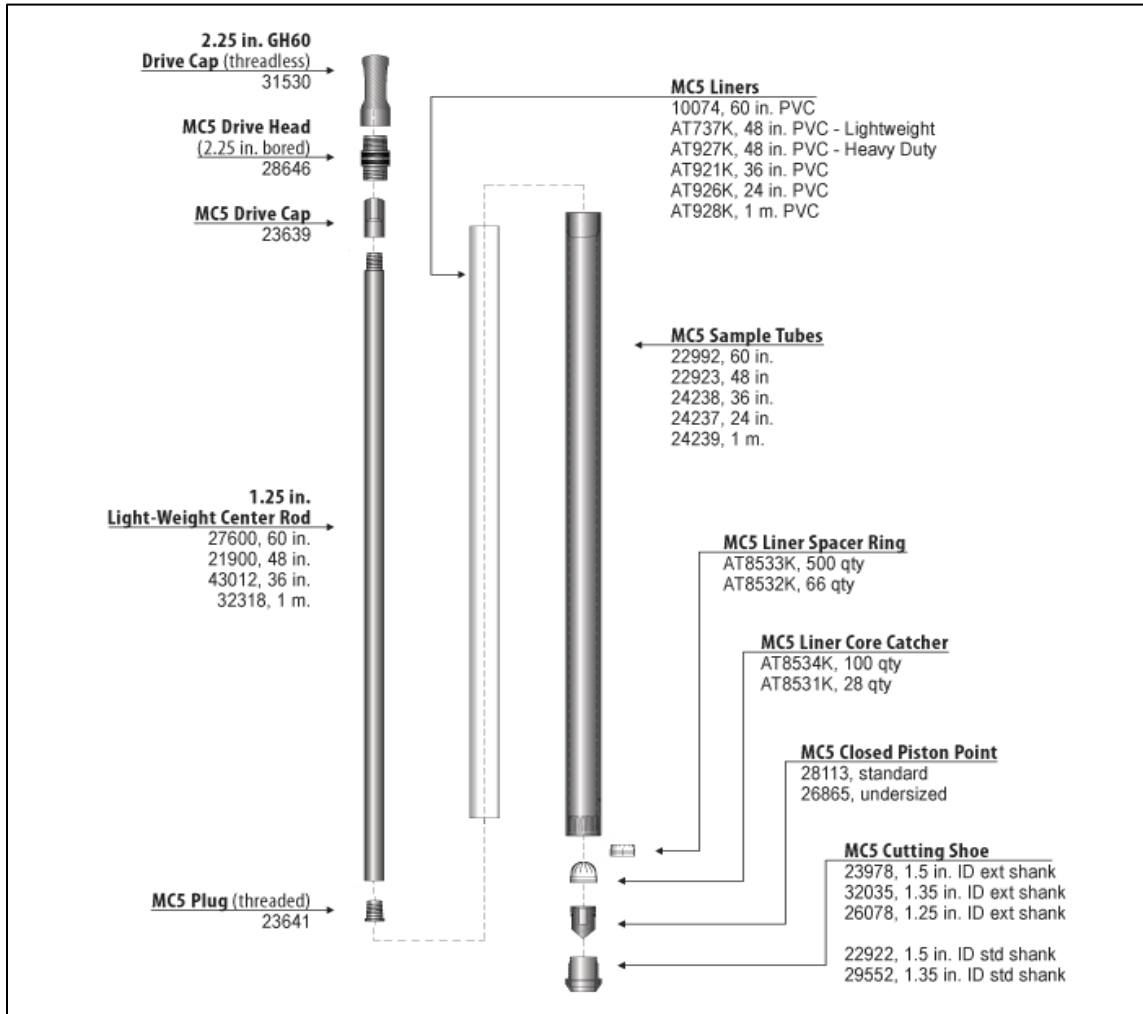

Figure 6.3 Penetrating Probe Sampler

Split Barrel (Spoon) Sampler

A split barrel sampler (Figure 6.4) is a push coring device often used with a drill rig to collect subsurface samples. The device is recommended for soil sampling, but can be used to sample other solids. The materials to be sampled should be moist enough to remain in the sampler. The sample volume range is 0.5 to 30.0 liters (ASTM D 6232).

The sampler consists of a length of steel tubing split longitudinally and equipped with a drive shoe, made of steel, and a drive head. The drive shoe is detachable and should be replaced when dented or distorted. The samplers are available in a variety of diameters and lengths. The split barrel is typically 18 to 30 inches in length with an inside diameter of 1.5 to 2.5 inches (ASTM D 4700, ASTM D 1586).

The split barrel sampler can be used to collect relatively undisturbed soil samples at considerable depths. The split barrel sampler may be driven manually, but is usually driven with a drill rig drive weight assembly or hydraulically pushed using rig hydraulics. The sampler is placed on the surface of the material to be sampled then pushed downward while being twisted slightly. Because pushing by hand may be difficult, a drop hammer typically is attached to a drill rig used to finish inserting the sampler. When the desired depth is reached, the sampler is twisted again to break the core; then, the sampler is pulled straight up and out of the material. The sample may be removed from the barrel or the liner may be capped off for analysis. Barrels may be extended to 5 inches in diameter (ASTM D 6232). Liners often are used when sampling for VOCs or other trace constituents of interest. With a liner, the sample can be removed with a minimum amount of disturbance. Liners (brass sleeves, plastics) should be compatible with the matrix and compounds of interest; some types of plastic liners may be inappropriate if analyzing for organics.



Figure 6.4 Split Barrel (Spoon) Sampler

Advantages

- Reusable, easily decontaminated, and easy to use.
- Provides a relatively undisturbed sample, therefore, can minimize the loss of volatile organic compounds.
- A variety of accessories are available for hard to sample media, such as trap valves for muddy soils and retainer baskets for fine grained materials.

Limitations

- Requires a drill or direct push rig for deep samples.
- Made of steel and may penetrate underground objects such as a pipe or drum.
- Only accommodates samples that contain particles smaller than the opening of the drive shoe (ASTM D 4700).

Other Guidance:

- Standard Guide for Selection of Sampling Equipment for Waste and Contaminated Media Data Collection Activities (ASTM D 6232)
- Standard Guide for Soil Sampling from the Vadose Zone (ASTM D 4700)
- Standard Test Method for Penetration Test and Split-Barrel Sampling of Soils (ASTM D 1586)

Thin-Walled Tube (Shelby Tube) Sampler

A thin-walled tube (Figure 6.5) is a type of push coring device recommended for sampling cohesive, unconsolidated solids – particularly soil. It is not recommended for gravel or rocky soil. The sample volume range is 0.5 to 5.0 liters (ASTM D 6232). The tube generally is constructed of carbon stainless steel, but can be manufactured from other metals (ASTM D 4700). It is commonly 30-inches long and is readily available in 2-, 3-, and 5-inch outside diameters (ASTM D 4700). The tube is attached with set screws to a length of a solid or tubular rod, and the upper end of the rod, or sampler head, is threaded to accept a handle or extension rod.

Typically, the length of the tube depends on the desired sampling depth. Its advancing end is beveled and has a cutting edge with a smaller diameter than the tube inside diameter. The tube can be used in conjunction with drills, from hand-held to full-sized rigs. The end of the sampler is pushed directly into the media using a downward force on the handle. It can be pushed downward by hand, with a jack-like system, or with a hydraulic piston. Once the desired depth is reached, the tube is twisted to break the continuity of the tip and is pulled from the media. The sample material is extruded into the sample container by forcing a rod through the tube. A paring device has

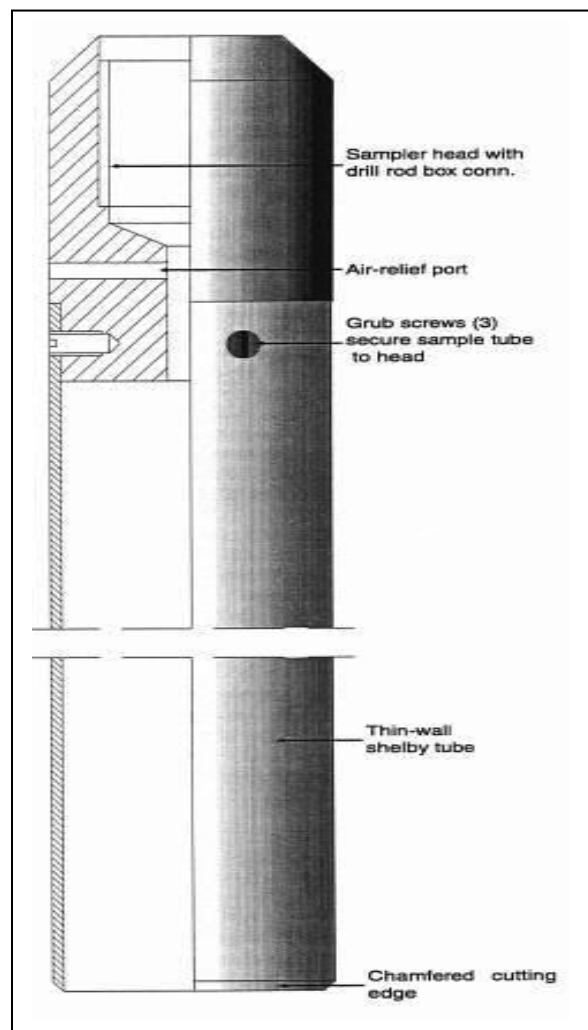

Figure 6.5 Thin-Walled Tube (Shelby Tube) Sampler

been developed to remove the outer layer during extrusion (ASTM D 4700). Plastic and PTFE sealing caps for use after sampling are available for the 2-, 3-, and 5-inch tubes.

Advantages

- Readily available, inexpensive, and easy to use.
- Reusable and can be decontaminated.
- Obtains a relatively undisturbed sample.

Limitations

- Some thin-walled tubes are large and heavy.
- The material to be sampled must be of a physical consistency (cohesive solid material) to be cored and retrieved within the tube. It cannot be used to sample gravel or rocky soils.
- Some volatile loss is possible when the sample is removed from the tube.
- The most disturbed portion in contact with the tube may be considered unrepresentative. Shorter tubes provide less-disturbed samples than longer tubes.
- Materials with particles larger than one-third of the inner diameter of the tube should not be sampled with a thin-walled tube.

Other Guidance

- Standard Guide for Selection of Sampling Equipment for Waste and Contaminated Media Data Collection Activities (ASTM D 6232)
- Standard Guide for Core Sampling of Submerged, Unconsolidated Sediments (ASTM D 4823)
- Standard Practice for Thin-Walled Type Geotechnical Sampling of Soils (ASTM D 1587)
- Standard Guide for Soil Sampling from the Vadose Zone (ASTM D 4700)

Miniature Core Sampler

The miniature core sampler (Figure 6.6) can be used to collect soil and waste samples for volatile organics analysis. These include devices such as the Purge-and-Trap Soil Sampler™, the En Core® sampler, the Terra Core™ sampler, or a cut plastic syringe (see [Section 6.0 of SW-846 Method 5035](#) and ADEQ substantive policy 0170). A miniature core sampler is a single-use push coring sampling device that also can be used as an airtight sample storage and shipping container. It collects a small contained subsample and is particularly useful for the sampling and analysis of VOCs. It is recommended for sampling soil, from the ground or the side of a trench, and may be used for sampling sediment and unconsolidated solid wastes. It cannot be used for sampling cemented material, consolidated material, or material having fragments coarse enough to interfere with proper coring. The En Core® sampler can be used to collect subsamples from soil cores and has a sample volume range of 0.01 to 0.05 liters (ASTM D 6232). The device is available from the manufacturer in two sizes for collection of 5- and 25-gram samples (assuming a soil density of 1.7 g/cm³). The size is chosen based on the sample size required by the analytical procedure. SW-846 Method 5035, “Closed-System Purge-and-

Trap and Extraction for Volatile Organics in Soil and Waste Samples,” recommends that samples not be stored in the device longer than 48 hours prior to sample preparation for analysis. The manufacturer’s instructions for sample extrusion should be followed carefully.



Figure 6.6 Miniature Core Sampler

Advantages

- Maintains sample structure in a device that also can be used to store and transport the sample directly to the laboratory.
- Recommended for collecting samples for the analysis of volatile compounds. It collects a relatively undisturbed sample that is contained prior to analysis to minimize the loss of volatile compounds.
- Usually is compatible with the chemicals and physical characteristics of the sampled media.
- No significant physical limitations for its use.
- Cross-contamination should not be a concern if the miniature core sampler is certified clean by the manufacturer and employed as a single-use device.

Limitations

- Cannot be used to sample gravel or rocky soils.
- Instructions should be followed carefully for proper use to avoid trapping air with the sample and to ensure that the sample does not compromise the seals.

Other Guidance

- Standard Guide for Selection of Sampling Equipment for Waste and Contaminated Media Data Collection Activities (ASTM D 6232)
- Standard Practice for Using the Disposable En Core Sampler for Sampling and Storing Soil for Volatile Organic Analysis (ASTM D 6418)
- Standard Guide for Sampling Waste and Soils for Volatile Organic Compounds (ASTM D 4547)

Modified Syringe Sampler

A modified syringe sampler (Figure 6.7) is a push coring sampling device constructed by the user by modifying a plastic, single-use, medical syringe. It can be used to provide a small, sub-sample of soil, sediments, and unconsolidated solid wastes. It is sometimes used to sub-sample a larger core of soil. It is not recommended for sampling cemented material, consolidated material, or material having fragments coarse enough to interfere with proper coring. Unlike the En Core® sampler, it should not be used to store and ship a sample to the laboratory. Instead, the sample should be extruded into another container.

Although the modified syringe sampler does not provide as contained a sample as the En Core® sampler, it can be used for sampling volatile compounds, as long as sample extrusion into another container, such as for methanol preservation, is quickly and carefully executed. The modified syringe sample has a volume range of 0.01 to 0.05 liters (ASTM D 6232).

A modified syringe sampler is constructed by cutting off the lower end of the syringe attachment for the needle. The rubber cap is removed from the plunger, and the plunger is pushed in until it is flush with the cut end. For greater ease in pushing into the solid matrix, the front edge sometimes can be sharpened (ASTM D 4547). The syringe sampler is then pushed into the media to collect the sample, which then may be placed in into another container, such as for methanol preservation, and transported to the laboratory. The sample is immediately extruded into the vial by gently pushing the plunger. The volume of material collected should not cause excessive stress on the device during intrusion into the material, or be so large that the sample falls apart easily during extrusion.



Figure 6.7 Modified Syringe Sampler

Advantages

- Obtains a relatively undisturbed profile sample.
- Can be used for the collection of samples for the analysis of volatile compounds as long as sample extrusion is quickly and carefully executed.
- No significant physical limitations for its use.
- Low-cost, single-use device.

Limitations

- Cannot be used to sample gravel or rocky soils.
- Material of construction may be incompatible with highly contaminated media.
- Care is required to ensure that the device is clean before use.
- The device cannot be used to store and transport a sample.

Other Guidance

- Standard Guide for Selection of Sampling Equipment for Waste and Contaminated Media Data Collection Activities (ASTM D 6232)
- Standard Guide for Sampling Waste and Soils for Volatile Organic Compounds (ASTM D 4547)

Rotating Coring Devices:

Rotating coring devices include equipment that obtains vertical columns of a solid sample through a rotating action. Some of these devices (such as augers) also can be used for just boring a hole for sample collection at a certain depth using another piece of equipment. The following summary for a hand auger is provided:

Hand Auger

The hand or bucket auger (Figure 6.8) is a hand operated rotating coring device generally used to sample soil, sediment, or unconsolidated solid waste. It can be used to obtain samples from drums, storage containers, and waste piles. The sample volume range is 0.2 to 1.0 liters (ASTM D 6232). The cutting head of the auger bucket is pushed and twisted by hand with a downward force into the ground and removed as the bucket is filled. The empty auger is returned to the hole and the procedure is repeated. The sequence is continued until the required depth is reached.

The same bucket may be used to advance the hole if the vertical sample is a composite of all intervals; however, discrete grab samples should be collected in separate clean auger buckets. The top several inches of material should be removed from the bucket to minimize chances of cross-contamination of the sample from fall-in material from the upper portions of the hole. Note that hand augering may be difficult in tight clays or cemented sands. At depths approaching 20 feet (6 m), the tension of hand auger extension rods may make operation of the auger too difficult. Powered methods are recommended if deeper samples are required (ASTM D 6232).

Advantages

- Reusable and easy to decontaminate.
- Easy to use and relatively quick for shallow subsurface samples.
- Allows the use of various auger heads to sample a wide variety of soil conditions.
- Provides a large volume of sample in a short time.

Limitations

- Depth of sampling is limited to about 20 feet (6 m) below the surface.
- Not suitable for obtaining undisturbed samples.
- Requires considerable strength to operate and is labor intensive.
- Not recommended for sampling soils for volatile organic compounds.

Other Guidance

- Standard Guide for Selection of Sampling Equipment for Waste and Contaminated Media Data Collection Activities, ASTM D 6232
- Standard Practice for Soil Investigation and Sampling by Auger Borings, ASTM D 1452
- Standard Guide for Soil Sampling from the Vadose Zone, ASTM D 4700
- Standard Practice for Sampling Unconsolidated Waste From Trucks, ASTM D 5658
- Standard Guide for Sampling of Drums and Similar Containers by Field Personnel, ASTM D 6063
- “Waste Pile Sampling” (EPA 1994)



Figure 6.8 Hand Auger

6.1.4 Soil Sampling for Direct Contact Exposure Considerations

An important exposure pathway to investigate at current and future residential property is associated with heavy metal, pesticide, and some of the heavier semi-volatile organic compound releases. Historical information on past uses of the property and surrounding industries developed during the CSM is crucial for the design of sampling plans that are intended to delineate contaminant zone(s) and for the interpretation of data generated from sampling efforts. Different sources of contamination may result in different sampling strategies. In addition to gathering data on the nature of the source of contamination, information should be gathered to identify areas where soils may have been moved or where fill or topsoil may have been placed.

Sites with “uniform” contamination over large areas:

Towns and cities with smelters or large agricultural areas are apt to have soil contamination derived from airborne pollutants (e.g. heavy metals, pesticides). Initial investigative sampling strategies are usually grid-patterned in character. This type of sampling pattern will allow concentration contours to be defined across the area and assist in establishing the extent of horizontal contamination. Smaller areas (i.e. residential sized lots) can then be sampled as a follow-up to the initial sampling. The results of the sampling in the smaller sized areas can assist in establishing whether or not clean-up standards have been exceeded at those residential sized (or smaller) lots.

Sites with “non-uniform contamination over large areas

Mining site locations with one or more tailings piles (i.e. contaminant source areas) are apt to have soil contamination derived from wind, water or gravity erosion of tailings piles. Delineating the contaminant zones by establishing concentration contours will be more uncertain at these sites. Sampling strategies should consider sampling every residential property in the potentially affected area. The sampling strategy should consider sampling the areas closest to the tailings piles first and then moving laterally away from the source until the lateral extent of contamination is identified.

6.1.4.1 Sampling Design Example

It should be noted that the example below is only addressing the need for a removal action of the upper one foot of soil. In addition to the sampling design scheme presented, the required depth of vertical characterization should always consider SRLs and GPLs. Additionally, a Declaration of Environmental Use Restriction may be required if the soil remaining on the property exceeds the rSRLs or unless a site specific risk assessment documents the site is not a threat to human health or the environment. Lastly, composite versus discrete soil sampling and the size of the exposure area decision unit should be carefully evaluated during the data quality objective process.

The sampling design example (for a metals or non-VOC investigation) in Figure 6.9 assumes that the removal of surficial contaminated soils and replacement with a cover of one foot (12 inches) of clean soil will be protective of human health and the environment. EPA experience demonstrates that a minimum of twelve inches of clean soil establishes an adequate barrier associated with direct contact exposure from deeper contaminated soil in residential yards (EPA, 2003). Cover soil can either be placed after excavation as backfill or placed on top of the contaminated yard soil. With the exception of gardening, the typical activities of children and adults in residential properties do not extend below a 12 inch depth. Thus, placement of a barrier of at least 12 inches of clean soil will generally prevent direct human contact and exposure to contaminated soil left at depth.

Twenty-four (24) inches of clean soil cover is generally considered to be adequate for areas where gardening occurs. Site-specific conditions such as the presence of burrowing animals may require more soil cover than the 24-inch barrier. A 24-inch barrier normally is necessary to prevent contact of contaminated soil at depth with plant roots, root vegetables, and clean soil that is mixed via deep rototilling. Raised garden beds may be built to obtain 24 inches of clean soil, and may be more cost effective than excavating to 24 inches in depth.

Initial sampling for non-VOC contamination in residential soils should be conducted to a depth of at least 18 inches, but does not need to exceed 24 inches to define the vertical extent of contamination for direct contact exposure remediation purposes. Composite samples should be collected at 6 inch depth intervals (i.e., 0–6 inches, 6–12 inches, 12–18 inches, and 18–24 inches). Composites should consist of aliquots collected from the same depth interval. Composite samples should also consist of discrete aliquots of equal amounts of soil. The soil from each aliquot should be collected into one clean container, such as a stainless steel bowl or plastic bag, and thoroughly mixed. After mixing, the sample can then be analyzed by X-Ray Fluorescence (XRF) and/or sent to the laboratory. Care should be taken when analyzing both lead and arsenic by XRF as high lead concentrations will significantly raise the detection limit for arsenic in some XRF machines.

It is recommended that when sampling residential lots with a total surface area less than 5,000 square feet (a typical urban lot size), five-point composite samples should, at a minimum, be collected from Front Yard and Back Yard decision unit (see section 5.2 of this guidance manual). The front, back, and side (if needed) yard composites should be equally spaced within the respective portion of the yard, and should be outside of the drip zone and away from influences of any other painted surfaces (Figures 6.9 and 6.10).

Heavy metal contaminated soils are frequently found within the drip line of houses. It is recommended a four-point composite sample be collected from the Drip Line decision unit of each residential property. The composite sample (taken from any size lot) should consist of a minimum of four aliquots collected between 6 and 30 inches from the exterior walls of the house. Each aliquot should generally be collected from the midpoint of each side of the house.

Collection of additional aliquots should be considered if other factors exist, such as bare spots, distinct differences in the house exterior, and areas where runoff collects. Rooftops may collect fine-grained sediments that contain high concentrations of heavy metals. In yard areas where downspouts discharge during a storm event, the fine-grained material washed from a roof may accumulate and result in a localized increase in soil concentrations. Samples of the soil from the downspout discharge area should also be sampled if present.

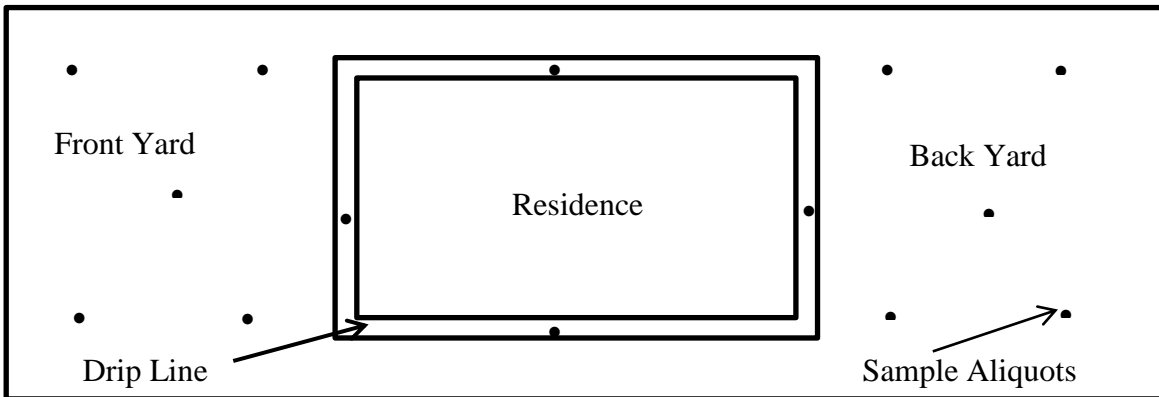

Figure 6.9 Recommended Minimum Soil Sampling in yards less than or equal to 5,000 square feet with small side yard.

For residential lots with a total surface area greater than 5,000 square feet, it is advisable that the property be divided into four decision units of roughly equal surface area. The two decision units in the front yard should encompass one half of the side yard; likewise for the two decision units in the back yard. One five-point composite of aliquots collected at equal spacing and from the same depth interval should be obtained from each quadrant. Each aliquot should be collected away from influences of the drip zone and any other painted surfaces (Figure 6.10).

Properties over one acre in size should be divided into typical residential sized lots (e.g. one-quarter to one-half acre) decision units. Smaller decision units should be considered for areas of the property based on exposure duration (see Section 5.2.1.1 and Figure 5.4) of this guidance manual). One five-point composite sample should be collected from each decision unit. For large properties, consideration should be given to whether elevated concentrations trigger partial removal of soils.

In addition to the composite samples collected to define the vertical extent of contamination associated with direct contact exposure, five-point composite surface soil samples should be collected from 0 to 1 inch for human health risk assessment purposes (EPA 1989, 1996). These surface soil samples should be collected from every property within the identified zone of contamination; however, after collecting a statistically valid number of both 0–1" and 1–6" samples, the project manager may want to statistically compare both sample horizons (Gilbert 1987; Snedecor and Cochran 1989) to determine

if the 0–1" depth can be eliminated (i.e., sample from 0–6") from risk assessment considerations, to decrease sampling costs.

This approach may be particularly useful at mine waste sites where contamination often extends to depth or at sites where heavy metal contaminated soil has been used as fill material. In such cases, the concentration may increase with depth. Conversely, the 0–1" horizon may be far more contaminated than the 1–6" at smelter sites, making individual horizon sampling crucial to remedial decision-making.

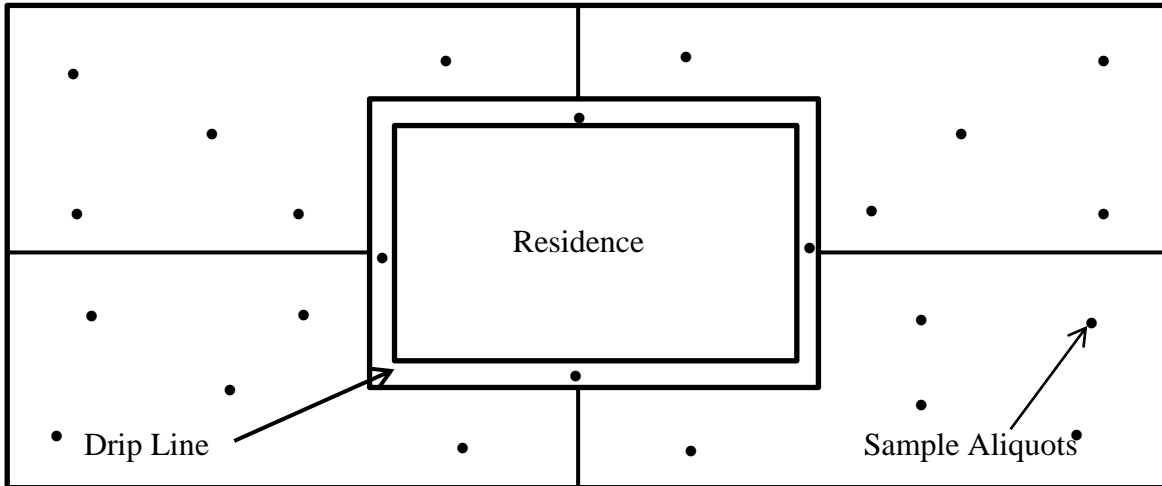

Figure 6.10 Recommended Minimum Soil Sampling in yards greater than 5,000 square feet.

Distinct play areas and gardens, if present, should generally be sampled as separate decision units. At some sites, collection of a right-of-way/easement composite may also be appropriate (e.g. residential areas with unpaved streets and alleys). Paved surfaces such as asphalt/concrete driveways, patios, alleys, and parking lots should, in most cases, not be sampled. Samples from other locations should be collected depending upon the potential for exposure or recontamination (e.g. under porches and crawl spaces and areas with incomplete barriers such as gravel driveways).

Please note that volatile organic compounds and some semi-volatile organic compounds attenuate relatively quickly and are not normally present in soils shallower than two feet. Sampling for VOCs in a residential setting may be spaced horizontally as described above but are not typically collected at depths less than two feet and should not be composited due to their volatility.

6.1.5 Soil Solid Sampling – Assessing Vertical and Lateral Extent of Contamination

Investigating and characterizing the vertical and lateral extent of contaminated soil resulting from releases is essential to producing and/or updating a CSM. The vertical

extent of soil contamination should be investigated for each suspected or confirmed source area identified in the CSM. A soil boring should be placed as close as practicable to each identified source area release point. As discussed in section 5.2.1, a source area is defined as an area of known contamination where a specific concentration threshold may be applicable. Please note that, in addition to other factors such as SRLs, the minimum GPLs should be taken into consideration during the investigative process. The depth of incorporation (see Figure 6.11) is defined at where the depth of minimum GPL is located.

Please note that, during UST closures, distinct soil samples must be collected every twenty (20) linear feet beneath the piping in native soils. Distinct soil samples must also be collected from native soils beneath elbows, joints, fittings, dispensers, ancillary equipment and areas of corrosion (AAC R18-12-272(A)(2)(e)). For larger diameter and/or longer pipelines (e.g. intrastate fuel pipeline or fuel hydrant system) than those typically found in an UST system, other investigative methods or sampling scales may be more appropriate.

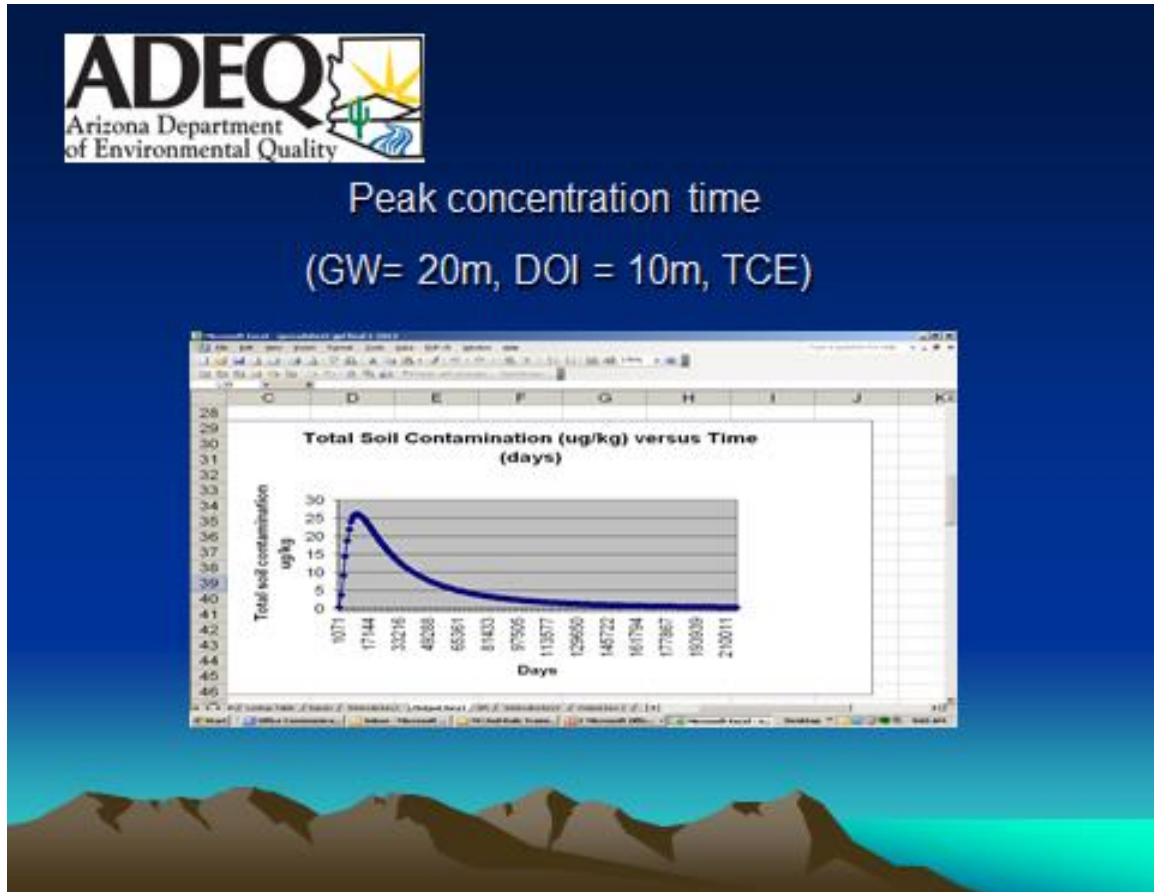

Figure 6.11 – Soil contaminant concentration versus time. DOI is depth of incorporation.

Typically, soil samples from the soil borings should be collected and chemically analyzed no more frequent than every five vertical feet of drilling or, depending on lithology and what is already known about contaminant distribution, at least every ten linear feet of

drilling. Please note, though, that sample collection intervals may be greater than every 10 feet if there is no rationale to collect samples at 10 foot intervals. The following considerations should be taken into account for collection and analysis of soil samples at intervals less than every 5 or 10 feet of drilling:

- significant changes in lithology; and
- field screening results indicate a significant rise in contaminant levels

Where collection of split-spoon samples, or other cored samples are not feasible or available (i.e., in coarse-grained soils or consolidated lithologies), the vertical extent of vadose zone contamination may need to be defined through the use of soil vapor sampling (see section 6.2) or the installation of a groundwater monitor well(s) in the upper most aquifer. Please note that, depending on site specifics (e.g. coarse lithology or not knowing the migration route of contamination through the subsurface), it may be more appropriate to collect soil vapor samples in lieu of soil solid samples, especially during early investigative stages. Please see the last few paragraphs of Section 6.1.6 for further elaboration. The decision to cease vadose zone investigative activities should consider the following factors:

- Depth to groundwater;
- Nature of the lithologic materials, especially the contamination migration pathways;
- Nature and toxicity of released substance(s);
- Nature of the release(s), (e.g. whether the release(s) emanated from a continuous dissolved source or a free product release), and whether concentrations of the released substance(s) in soil matrices are at or below residual soil saturation;
- Proximity of the release(s) to groundwater or surface water;
- Representativeness of the soil samples collected compared to *in situ* soil conditions and contaminant concentrations; and
- Other site specific factors.

If the laboratory data collected from the source area boring(s) indicate that contaminant concentrations exceed the pre-determined rSRLs or GPLs, additional soil borings should be drilled to define the lateral extent of source area contamination. The borings should be drilled to the depth that the vertical extent of soil contamination is defined. Professional judgment may be used to advance drilling to depths greater than the depth of the source area boring when supported by site-specific conditions. (e.g. encountering coarse grained lenses that prevent the collection of a representative soil sample).

The lateral extent source area borings should be placed evenly around the release point(s), such as releases from storage tanks or drywells, at approximately 120-degree spacing as site conditions allow. The lateral distance between the initial release location boring and each lateral extent boring should be based on the lithology at the site and the vertical extent of contamination. Typically, lateral borings are placed 15 feet to 30 feet from the source area boring, but may be less or more dependent on professional judgment

(e.g. coarse grained lithology would have lateral borings placed at closer distances from the source area boring). The investigative levels that should not be exceeded by the lateral extent borings are also the pre-determined rSRL, or the minimum GPL whichever is lower.

In the event that placing three borings around the release point(s) is not practical (i.e., utilities, structures, access issues), the total number of borings to define the lateral extent of contamination may be reduced if no significant stratigraphic variation in the vicinity of the release(s) is observed during the investigation. A reduction in the number of borings may be appropriate under the assumption that the release(s) has a symmetrical geometry. Collecting field data regarding lithology and using that data in conjunction with other site specific data to make a decision to reduce the number of drilling locations is an example of a **recognition-primed decision** (see Section 5.1.2.2).

6.1.6 NAPL Investigation

NAPLs are thought to most commonly exist as ganglia (small, discrete blobs of NAPL “trapped” in pore spaces) and to a lesser extent in small, continuous lenses that can be oriented either vertically or horizontally from the original point of entry into the subsurface. These ganglia and small, isolated lenses of NAPL are very difficult to discover using standard investigation techniques such as soil borings because of their small size and distribution.

A common objective of NAPL site investigations is to estimate the volume and extent of NAPL present in the subsurface at the site, as required to assess the human health and environmental risk and implement appropriate remedial techniques. By using field analytical techniques that produce near real-time data, the on-site decision maker significantly reduces the uncertainty contributed to the overall investigation from sample location selection. **Real-time data** coupled with real-time (**recognition-primed**) decision making allows rapid iteration to locate and assess contaminant distribution at the site (Robbat, Smarason, and Gankin, 1998; Robbat, Smarason, and Gankin, 1999; Crumbling et al., 2001).

Large amounts of data are necessary to characterize a NAPL site. It can be cost prohibitive and time consuming to analyze large numbers of samples with laboratory analytical and data validation. Using a lower cost analytical method allows the investigator to collect and analyze a much greater number of samples. A greater number of samples can provide a significantly better understanding of the contaminant distribution, allowing accurate and prompt adjustments of the conceptual model.

Experience has demonstrated that using field based analytical methods allows accurate sample location selection, thus leading to a significant reduction in the uncertainty of the data set produced to assess site conditions (Crumbling et al., 2001). Table 5.2 lists a variety of techniques that can be used to quickly analyze environmental samples. These include field characterization techniques such as field gas chromatography,

immunoassay, and direct sampling ion trap mass spectrometry (EPA Method 8265). Screening methods, such as the use of a photo-ionization detector or organic vapor analyzer, can also be useful. Laboratories can also sometimes develop quick and accurate screening techniques to analyze samples. Using these modified analytical techniques allows the investigator to develop a large data base that accurately describes the general site conditions and provides realistic indications of whether or not NAPL is present and where it might be located. The more data collected during the investigation, the more likely the investigator is to determine if NAPL is present and to accurately characterize NAPL source areas.

Representative data are very important and the dynamic work plan process strives to collect data that are accurately representative of the intended project decisions. The selection of acceptable field-based methods includes understanding the limitations of the techniques and deciding on data accuracy requirements during the early planning stages of any investigation. In the Triad approach, the term “Decision Quality Data” is used to refer to data for which both the sampling and analytical representativeness have been specifically tailored to project decision-making needs. This means:

1. The analytical methodologies should be researched and determined to be acceptable prior to use (often through a “methods applicability study”);
2. The operator should follow the standard operating procedures (SOPs) developed for the project;
3. The equipment should be calibrated as often as is warranted.
4. Duplicates collected at a percentage of the locations, usually 10 percent, and sent for comparison analysis by more rigorous or selective laboratory methodologies to assess for analytical bias and precision of field-generated data.
 - a. If the laboratory analyses show that the field methods are unacceptable, the problems with the field method should be solved and more samples taken and reanalyzed.

Soil Vapor Surveys Use in Field Investigations:

Active and passive soil vapor surveys are good sampling techniques for locating unidentified source areas in the vadose zone (where the NAPL chemical is volatile). Depending on site specific conditions and project objectives, soil vapor sampling may be a logical choice over soil solid sampling for profiling the vertical extent of contamination in source area locations. It should be remembered that NAPL may migrate laterally as well vertically, following either natural or manmade conduits, and may migrate in different directions at different depths. Soil vapor surveys are often first conducted in a grid pattern over a site with a denser grid used in areas where it is expected that NAPLs were released (see Section 6.2 – Soil Vapor Sampling for more information).

Care should be exercised when interpreting the results of soil vapor surveys to consider that data may be skewed by natural and anthropogenic features of high air permeability,

such as buried stream channels and utility trenches. In addition, pavements and buildings may trap vapors and cause anomalously elevated VOC concentrations in the soil vapor samples. As in all environmental site investigations, a detailed understanding of the geology can help tailor the investigation to best fit the site characteristics.

Direct push technologies are commonly used to sample for soil vapor but tend to be limited to the shallow portions of the vadose zone. For example - many parts of the west have cobble zones associated with high energy stream deposits. The cobble zones limit the depth to which direct push technologies can reach. Deeper investigations are usually performed with a combination of drilling, soil vapor sampling and soil sampling. If soil sampling alone is utilized, the chances of locating a NAPL source without previous soil vapor work is diminished - except in the case of massive NAPL contamination. However, if the NAPL in the vadose zone is not volatile, it will be necessary to take numerous discrete soil samples to characterize the NAPL.

Important Information You Shown Know after Reading Section 6.2 – Soil Vapor Sampling:

1. [The two basic types of soil vapor surveys.](#)
2. [How soil vapor is generated and transported.](#)
3. [The applications of soil vapor surveys.](#)
4. [Advantages of soil vapor samples.](#)
5. [Active soil vapor sampling techniques.](#)
6. [Special considerations for Passive Soil Vapor Surveys.](#)

<p>Two types of soil vapor surveys:</p> <ol style="list-style-type: none"> 1. <u>Active soil vapor survey</u> - where a volume of soil vapor is pumped out of the vadose zone and into a sample container or directly into an analyzer. 2. <u>Passive soil vapor survey</u> - a sorbent material is buried in the vadose zone so that contaminant vapors can be selectively absorbed over time using the ambient flow of vapors through the subsurface. <p>Soil vapor generation:</p> <ol style="list-style-type: none"> 1. <u>Biologic decomposition</u> of organic wastes – important in most active and closed landfills. Under anaerobic conditions, organic wastes are primarily converted into carbon dioxide and methane. 2. <u>Chemical decomposition</u> resulting from the mixing of incompatible materials. A strong oxidizing agent may react with organic wastes to produce ammonia and carbon dioxide in acidic conditions. 3. <u>Physical decomposition</u> – volatilization of chemicals (mainly VOCs) in the subsurface is the most important physical process affecting soil vapor production. <p>Soil vapor transport mechanisms:</p> <ol style="list-style-type: none"> 1. <u>Molecular effusion</u> occurs at the surface boundary of the soil and atmosphere. 2. <u>Molecular diffusion</u> occurs when there is a concentration difference between two locations. Soil vapors move from high concentration areas to low concentration areas. 3. <u>Advection</u> is the transport mechanism by which soil vapor moves due to differences in pressure. Soil vapors move from an area of high pressure to an area of low pressure. 	<p>Applications of soil vapor surveys:</p> <table border="1" data-bbox="1106 520 2013 923"> <thead> <tr> <th colspan="2">Soil Vapor Sampling Applications and Results Category</th> </tr> <tr> <th>Application</th> <th>Category</th> </tr> </thead> <tbody> <tr> <td>Confirm releases to the environment</td> <td>Qualitative/Quantitative</td> </tr> <tr> <td>Identify source areas and release locations of VOCs/SVOCs</td> <td>Qualitative</td> </tr> <tr> <td>Identify potential soil sampling locations</td> <td>Qualitative</td> </tr> <tr> <td>Identify vapor migration routes</td> <td>Qualitative</td> </tr> <tr> <td>Focus remediation efforts</td> <td>Qualitative</td> </tr> <tr> <td>Track remedial progress</td> <td>Qualitative/Quantitative</td> </tr> <tr> <td>Gather data for risk assessment regarding vapor inhalation issues</td> <td>Quantitative</td> </tr> </tbody> </table> <p>Qualitative – QA/QC not as stringent. Used to compare one soil vapor survey result to another. Quantitative – QA/QC more stringent. For use when comparing to standards.</p>	Soil Vapor Sampling Applications and Results Category		Application	Category	Confirm releases to the environment	Qualitative/Quantitative	Identify source areas and release locations of VOCs/SVOCs	Qualitative	Identify potential soil sampling locations	Qualitative	Identify vapor migration routes	Qualitative	Focus remediation efforts	Qualitative	Track remedial progress	Qualitative/Quantitative	Gather data for risk assessment regarding vapor inhalation issues	Quantitative	<p>Active Soil Vapor Sampling Techniques:</p> <ol style="list-style-type: none"> 1. Temporary probes - Sample Through-the-rod and Post Run Tubing (PRT) methods are advantageous if only one sampling round is required. Shallow depth sample collection is the usual application. 2. Permanent probes – can use auger, air rotary or rotonomic drilling methods for permanent probes. Can install probes to depth and have nested wells to collect soil vapor samples from multiple depths at one location. Advantageous for long term monitoring of remedial systems.
Soil Vapor Sampling Applications and Results Category																				
Application	Category																			
Confirm releases to the environment	Qualitative/Quantitative																			
Identify source areas and release locations of VOCs/SVOCs	Qualitative																			
Identify potential soil sampling locations	Qualitative																			
Identify vapor migration routes	Qualitative																			
Focus remediation efforts	Qualitative																			
Track remedial progress	Qualitative/Quantitative																			
Gather data for risk assessment regarding vapor inhalation issues	Quantitative																			
	<p>Advantages of collecting soil vapor samples versus soil solid samples:</p> <ol style="list-style-type: none"> 1. Soil vapor samples represent a relatively larger volume of the vadose zone providing an average concentration for the area of concern. 2. Vapor samples may be collected and injected directly into a gas chromatograph from the sample container with no exposure to the atmosphere. 3. Vapor samples with high VOC concentrations can indicate the presence of nearby NAPL whereas a soil solid sample collected in the same location may miss that nearby source. 4. A vapor monitor well network can track progress and effectiveness of on-going remedial activities such as SVE. Collecting time-series soil matrix samples is difficult and expensive. 	<p>Special Considerations for Passive Soil Vapor Surveys:</p> <ol style="list-style-type: none"> 1. The adsorbent material should be hydrophobic to minimize water vapor uptake. 2. Exposure time: The sampler should be deployed long enough to adsorb a detectable mass, but not so much as to allow the adsorbent to become saturated. 3. Desorption and analytical method: The adsorbed compounds can be removed from the adsorbent by thermal desorption or solvent extraction and analyzed using gas chromatography (GC) or GC-mass spectrometry (GC/MS). Methods using thermal desorption have the benefit of greater method sensitivity than those using solvent extraction. 4. Sampler installation: For subslab sampling, a narrow-diameter hole is drilled through the slab, and the sampler is slipped into the hole beneath the slab, while the hole itself is sealed. <p>Deeper soil vapor sampling generally involves drilling a narrow-diameter hole at least 3–5 feet bgs. The passive sampler is inserted to depth and the installation hole is secured.</p>																		

6.2 Soil Vapor Sampling

There are two basic types of soil vapor surveys performed during site investigations. The first type is an active soil vapor survey where a volume of soil vapor is pumped out of the vadose zone and into a sample container or directly into an analyzer. The second type is the passive soil vapor survey where a sorbent material is buried in the vadose zone so that contaminant vapors can be selectively absorbed over time using the ambient flow of vapors through the subsurface.

Soil vapor surveys are routinely applied in the following ways:

- to confirm releases to the environment
- to identify source areas and release locations of VOCs/SVOCs
- to identify potential soil sampling locations
- to focus remediation efforts where necessary
- to identify vapor migration routes
- to track remedial progress
- to gather data for risk assessment regarding vapor inhalation issues

The term soil vapor or soil gas refers to the atmosphere present in soil pore spaces (Figure 6.12). Volatile chemicals introduced into the subsurface can be present in the vapor phase or, more commonly, can undergo a transition from a liquid or sorbed phase to become part of the soil atmosphere. The following will discuss how soil vapor is generated, movement of vapor in the vadose zone, sample collection methods and the uses of soil vapor sample results.

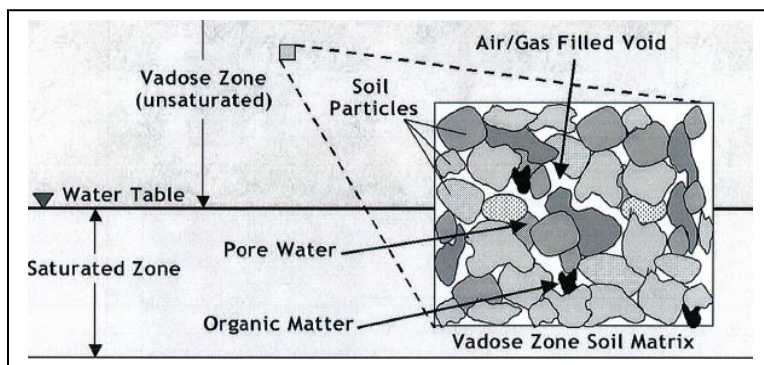

Figure 6.12 Soil Matrix Components (Geoprobe, 2006)

6.2.1 Soil Vapor Generation and Transport Mechanisms

Soil vapor may be generated by biological, chemical and physical decomposition of wastes released into the environment. Waste characteristics such as type, source, quantities and the geologic and geographic location of entry into the subsurface can affect the rate of decomposition and soil vapor production.

6.2.1.1 Biological Decomposition

Biological decomposition is important in most active and closed landfills containing organic wastes, which decompose due to anaerobic microbial degradation. Generally, the amount of gas generated in a landfill is directly related to the amount of organic matter present. Waste type and in-situ characteristics and conditions can affect biological decomposition. Landfill gas production will vary spatially within a landfill unit as a result of pockets of high microbial activity. Under anaerobic conditions, organic wastes are primarily converted by microbial action into carbon dioxide and methane. Also, trace amounts of hydrogen, ammonia, aromatic hydrocarbons, halogenated organics, and hydrogen sulfide may be present. Please note that biological decomposition can occur in anaerobic conditions in areas other than landfills, also.

6.2.1.2 Chemical Decomposition

Soil vapor production from chemical decomposition results from the mixing of incompatible materials. Reactive or ignitable wastes can cause explosions or heat producing reactions resulting in a rapid production of gases and increased temperatures. A strong oxidizing agent may react with organic wastes to produce ammonia and carbon dioxide in acidic conditions.

Under natural conditions, soil vapor production from chemical reactions is not expected to occur. These reactions are more likely to occur from liquids stored or spilled from underground storage tanks and pipelines.

6.2.1.3 Physical Decomposition

VOCs can undergo a variety of equilibrium and transport processes in the subsurface. The most important physical process affecting the production of vapors is the solution/vapor equilibrium. Due to the high vapor pressures and low aqueous solubility, volatile organic compounds have an affinity to partition into the vapor phase. The physical law that quantitatively describes this process is Henry's Law. VOCs with high Henry's Law constants will favor to partition from the aqueous to the vapor phase.

6.2.1.4 Transport Mechanisms

Several physical mechanisms describe the movement of vapors through the subsurface. They are molecular effusion, molecular diffusion and advection.

Molecular Effusion:

Molecular effusion (Figure 6.13) occurs at the surface boundary of the soil and atmosphere. It is the process by which vapors are released from the soil surface to the atmosphere. Any VOCs, which are in the soil surface, are released to the atmosphere based upon the vapor pressure of the VOC. One of the physical effects on the release rate of VOCs from the surface is windspeed. Wind keeps the ambient concentration at or near zero, which creates a concentration gradient for material to migrate to the surface.

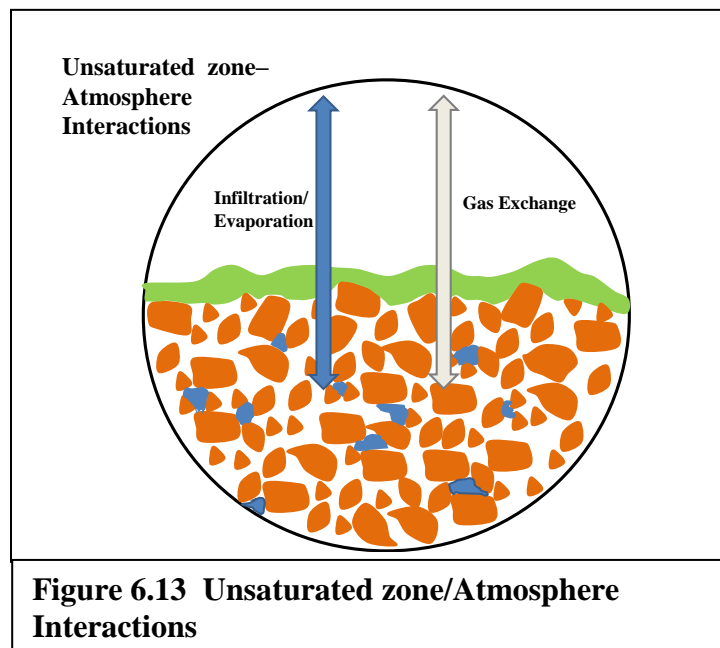

Figure 6.13 Unsaturated zone/Atmosphere Interactions

Variations in soil vapor concentrations near the soil surface can be due to temporal effects such as temperature changes, precipitation, and activities within any overlying structure. Variations will be greater the closer the samples are to the surface and are lessened with increasing depth. Generally, short-term variations in soil vapor concentrations at depths four feet or deeper are less than a factor of two and seasonal variations in colder climates less than a factor of five.

Larger variations in soil vapor concentrations may be expected in areas of greater temperature variation and during periods of heavy precipitation as described as follows:

Temperature: Effects on soil vapor concentrations due to actual changes in the vadose zone temperature will be minimal.

Precipitation: Infiltration from rainfall can potentially impact soil vapor concentrations by displacing the soil vapor, dissolving volatile organic compounds, and by creating a "cap" above the soil vapor. In most settings, infiltration from large storms only penetrates into the uppermost vadose zone. Soil vapor samples collected at depths greater than 3 to 5 feet below ground surface (bgs) under foundations or areas with surface cover are unlikely to be significantly affected. However, soil vapor samples collected closer to the surface (<3 feet) with no surface cover may be affected. If the moisture has penetrated to the sampling zone, it typically can be recognized by difficulty in collecting soil vapor

samples. If high vacuum readings are encountered when collecting a sample, or drops of moisture are evident in the sampling system or sample, measured values should be considered as minimum values. Measurement of percent moisture of the soil may also be useful if shallow sampling is performed during or shortly after significant rainfall (>1.0 inch).

Pressure: Barometric pressure variations are unlikely to have a significant effect on soil vapor concentrations at depths exceeding three to five feet bgs and only a minor effect (less than a factor of 2) at shallower depths unless a major storm front is passing through the area. A recent study in Wyoming (Luo et al., 2006) has shown little to no relationship between barometric pressure and soil vapor oxygen concentrations.

Human induced influences to pressure are likely to have a bigger effect upon soil vapor concentrations. For example, pressure changes resulting from the on-off cycling of an overlying building's heating or HVAC system and the ventilation of the structure due to open doors and windows can greatly influence soil vapor concentrations at locations near the building. In colder climates, greater impacts are most likely in the winter season. Literature suggests that temporal variations in radon concentrations are typically less than a factor of two and seasonal effects less than a factor of five (ITRC, 2007).

Molecular Diffusion:

Molecular diffusion (Figure 6.14) occurs when there is a concentration difference between two different locations. Diffusive flow is in the direction from high concentration to low concentration. The vapor density affects molecular diffusion, but the concentration will tend to overcome small differences in density. Specific compounds will exhibit different diffusion coefficients. In the soil atmosphere, the diffusion coefficients are only relative indicators due to the tortuous path (around soil particles) the vapors must travel in soil.

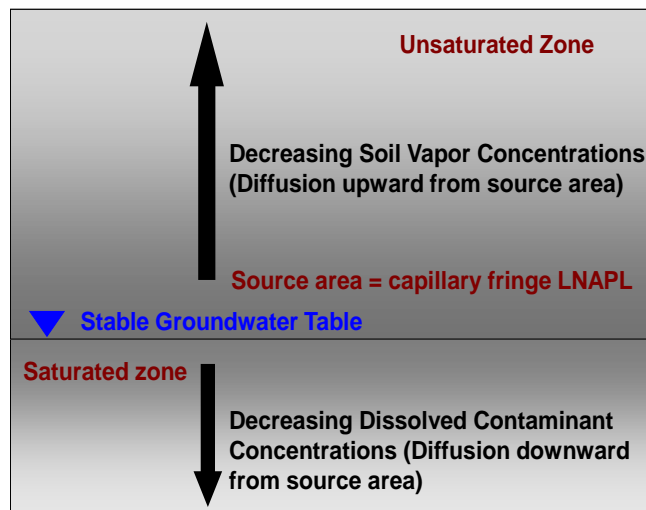

Figure 6.14 Molecular Diffusion of Soil Vapor

Advection:

Advection is the transport mechanism by which soil vapor moves due to differences in pressure. Vapor will flow from an area of higher pressure to an area of lower pressure. These pressure differences can be generated by atmospheric pressure changes,

temperature changes creating natural convection in the soil, or forced pressure changes due to building ventilation systems. Where it occurs, advective flow of vapor will overcome the influence of molecular effusion and molecular diffusion. Advective transport is likely to be most significant in the region very close to a basement or a foundation, and soil vapor velocities decrease rapidly with increasing distance from the structure (ITRC Vapor Intrusion Pathway: A Practical Guideline, January 2007, page 3). Also, this type of flow is usually associated with landfills. Biodegradation processes, chemical reactions within the landfill, compaction effects or methane generation in the lower regions of the landfill will drive vapors vertically and horizontally.

The soil vapor extraction (SVE) process also utilizes this transport mechanism for remedial purposes (Figure 6.15). The vacuum induced by an SVE system at the screened interval of a remedial well creates a continual low pressure zone surrounding the immediate area of screened interval as compared to that of the surrounding soil. The soil vapor from the surrounding soil travels to that lower pressure zone and is evacuated from the subsurface.

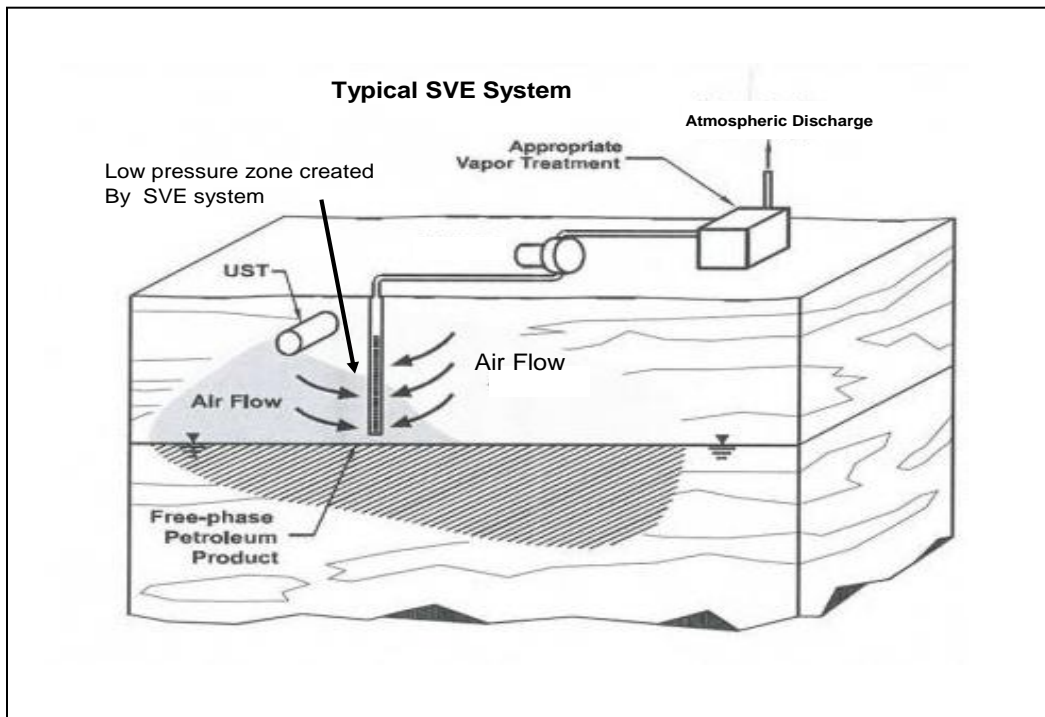

Figure 6.15 Low Pressure Zone at SVE Well Screen. An Operating SVE System Creating a Low Pressure Zone at Well Screen (Modified from EPA 1995)

6.2.2 Soil Vapor Sampling Techniques

There are many useful sources for gathering information regarding soil vapor sampling techniques. This section provides some useful installation/construction information. This section also provides a list of weblinks that may prove useful to the reader.

6.2.2.1 Active Soil Vapor Surveys

This section provides useful construction information and details for installation methods. Also, ADEQ has a [Substantive Policy on Soil Vapor Sampling](#) and can be found on the ADEQ website (www.azdeq.gov) by using its Search Engine (Key Phrase: Soil Vapor Sampling).

Sample Through-the-Rod and Post Run Tubing (PRT) methods (also known as temporary probes):

This method is advantageous if only one sampling round is required. Also, less material is placed in the ground, minimizing disturbance of the in-situ vapor and decreasing the need for collection of blanks.

The following construction details (also see Figure 6.16) should be considered for the collection of a sample through rods:

1. Seal probes at the surface with bentonite before sampling;
2. Utilize small diameter tubing (e.g. nylon, polyethylene, copper or stainless steel) which will not react, absorb or interact with site contaminants. It is suggested to use new tubing for new field events or demonstrate that the tubing you are using is contaminant free; and
3. When using direct-push borings for the installation of soil-vapor-sampling probes (Figure 6.16), avoid lateral movement of the probes once they are in the ground to prevent atmospheric air from entering the sampling system.

The main difference between Through-the-Rod and PRT methods sampling is that with the Through-the-Rod method, the soil vapor comes into contact with the inside of the through rod as it is being drawn up to the surface. The PRT method, though, has its tubing extended and attached to the bottom of the sample rod. This allows the soil vapor to bypass contact with the inside of the sample rod (which may not be clean after several samples have been collected). Also, it circumvents the worry of loose connections between sample rods and having soil vapor from an undesired depth entering the sample stream. Because of these factors, the PRT method has higher Quality Assurance than the Through-the-Rod method. Please refer to the website <http://geoprobe.com/literature/direct-push-installation-of-devices-for-soil-gas-sampling-and-monitoring-techbulletin-no-> for a description of direct push boring installation methods.

Permanent Probes:

The following construction details should be considered for the installation of permanent probes:

1. Use short discreet sampling intervals (e.g., 6 to 12 inches);
2. Color code or tag tubing of probes at the surface to be sure that the sampling depth is easily identifiable for future sampling events;
3. Complete and seal permanent probes at the ground surface (e.g., road boxes, locked caps, vapor-tight valves).

Types of Drilling:

When using auger, air rotary, or roto-sonic drilling methods for the installation of soil-vapor sampling probes, the following should be considered:

1. Install sampling probes with sand-pack intervals of approximately 1 foot;
2. Seal each sampling interval with bentonite or grout above and below the sand pack in the annulus of the boring. Care should be taken to ensure that the seal material does not intrude into the sand pack;
3. If dry bentonite is placed in the boring, care should be taken to fully hydrate the bentonite. Placing the bentonite in small increments (e.g., < 6 inches) followed by water is helpful. Alternatively, the bentonite can be added using a combination of dry and hydrated bentonite, or in slurry form if the boring is of sufficient diameter; and
4. For deeper probes, down-hole support rods may be necessary during probe installation, especially for tubing sized greater than 1/8-inch OD.

Please note that the PVC material can be utilized for monitoring well construction material, also (Figures 6.17 and 6.18).

Equilibration Time:

During probe installation, subsurface conditions are disturbed. For probes installed with hollow stem, air rotary, or roto-sonic drilling methods, purge volume test, leak test and soil vapor sampling should not be conducted for at least 48 hours (depending on site lithologic conditions and stage of investigation) following probe installation. When utilizing sample through rods or PRT, a 20 to 30 minute equilibration time is recommended.

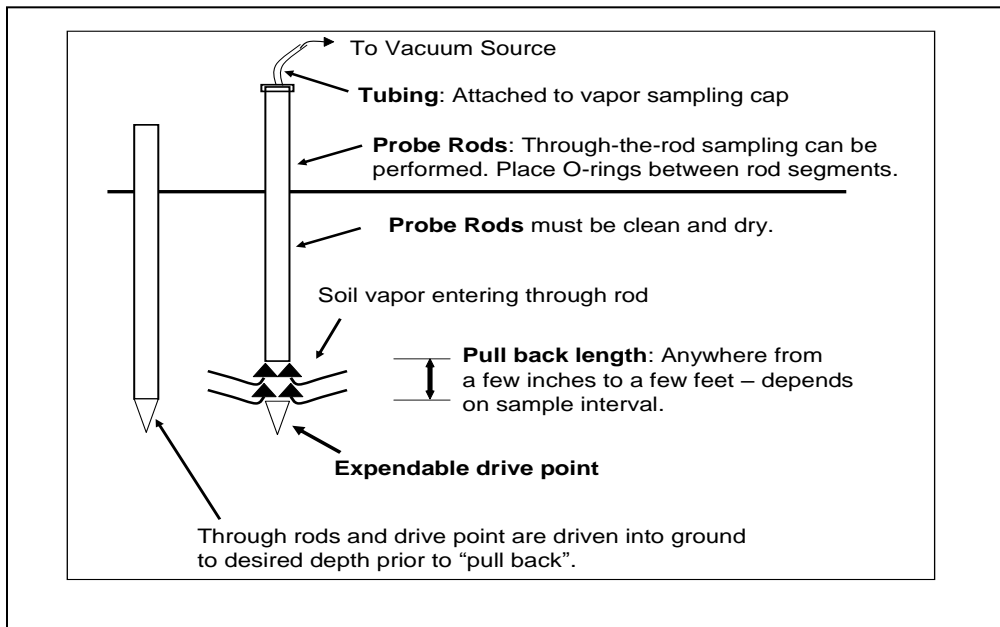

Figure 6.16 Through-the-rod sampling technique

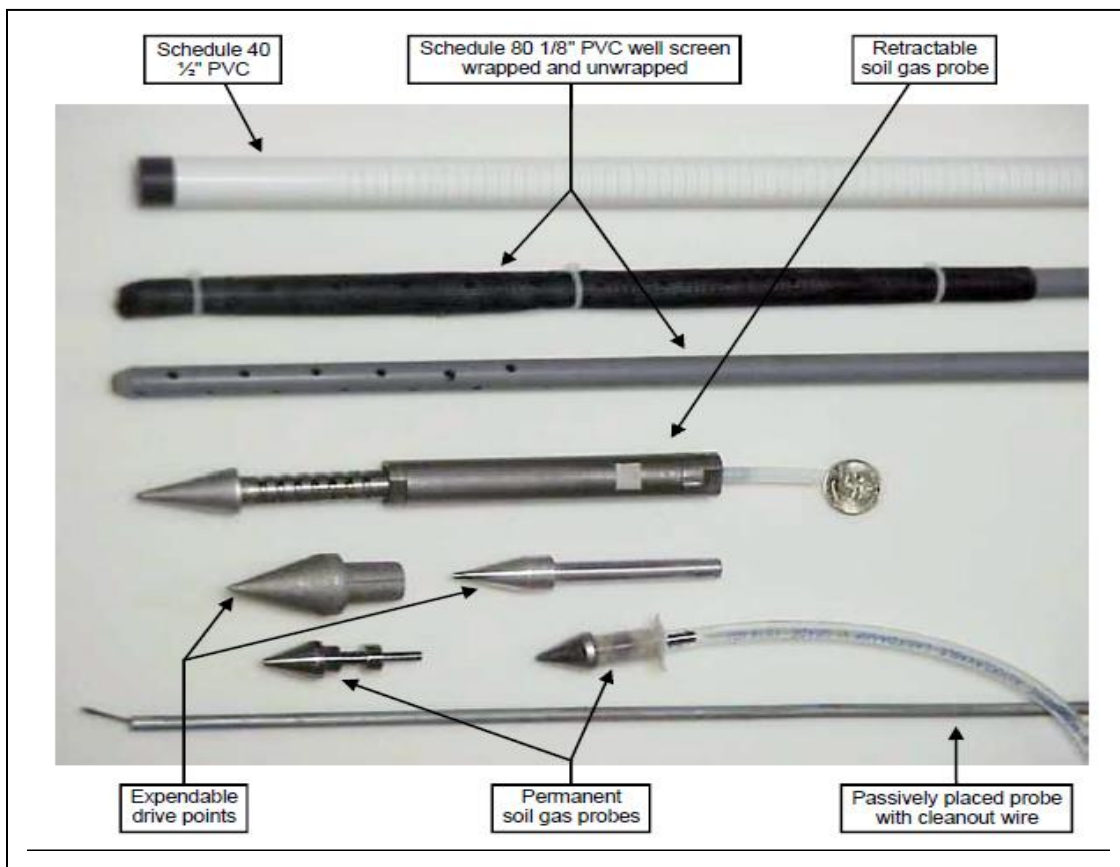

Figure 6.17 Soil Vapor Probes (NJDEP, 2005)

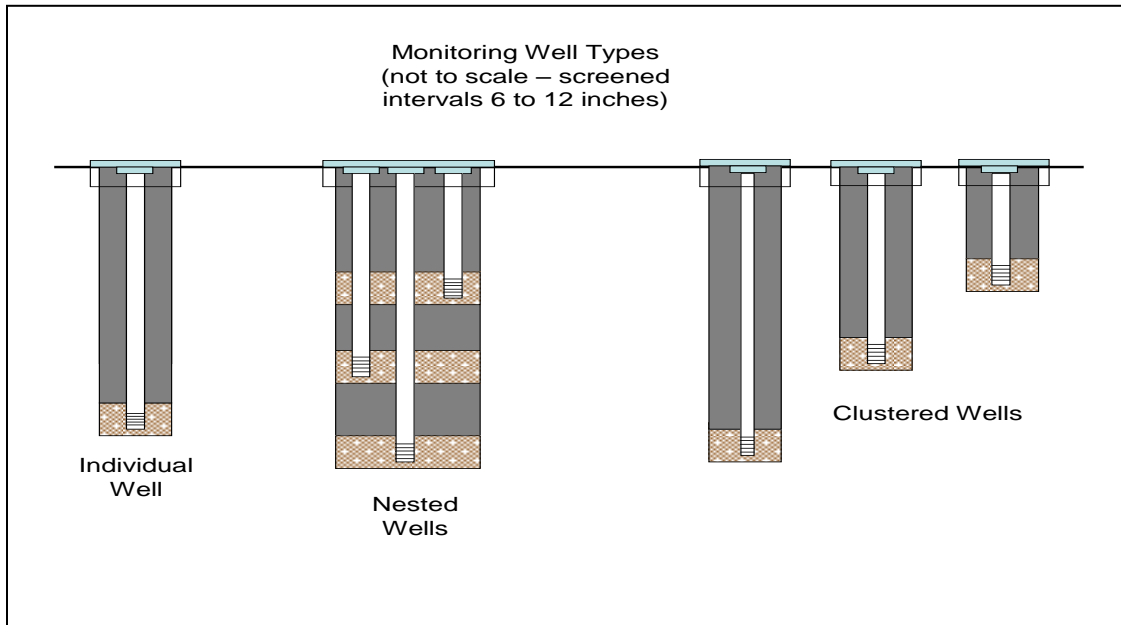

Figure 6.18 Monitoring Well Types for Soil Vapor Samples (PVC construction)

Undesirable Conditions for Collecting Active Soil Vapor Samples:

Soil vapor samples should not be collected if:

- a. The groundwater is very close to the ground surface (i.e., < 3 feet);
- b. Chemical(s) of concern is/are not volatile; and
- c. Moisture or unknown material is observed in the sample stream or sample container.

Please note that due to increased diffusivity, advective flow, and temperature fluctuations at near surface boundaries, the collection of a soil vapor sample in near surface soils is not useful for the purpose of calculating total soil solid VOC concentrations. Please refer to ADEQ's Soil Vapor Sampling Guidance for tests to determine if soil vapor sampling is practicable.

6.2.2.2 Passive Soil Vapor Surveys

Passive soil vapor survey methods consist of the burial of an adsorbent in the ground with subsequent retrieval and measurement of the adsorbent (Figure 6.19). With passive sampling, there is no forced movement of soil gas. Instead, as the vapors migrate, the sorbent acts as a sink for the organic compounds in the soil gas. This method gives a time-integrated measurement and therefore reduces the uncertainty due to temporal variations.



Figure 6.19 Sorbent strip in flux chamber
(Beacon-USA.com)

Passive soil vapor survey methods directly measure a mass of contaminant that has diffused onto an adsorbent media. Reporting units are typically in terms of mass (e.g., micrograms). Using relative mass levels, passive soil vapor can be a viable, cost effective, and simple screening tool to determine potential areas of concern.

While published methods exist that describe the procedures to generate contaminant concentration data from a passive sorbent-based sampler in air in the absence of soil, no published data or documents have demonstrated the applicability of the method to soil vapor. The fundamental difference is that the gas-phase diffusivity is known in the air, enabling a calculation of concentration from the adsorbed mass, but it is unknown in the vadose zone.

Field studies to calibrate the passive method to actual soil vapor concentrations are still too limited to validate the use of this method for quantitative soil vapor concentrations. For this reason, passive soil vapor is not presently considered to be applicable for stand-alone assessment of vapor inhalation risk. When compared to conventional drilling and sampling methods, passive methods offer a quick and relatively inexpensive method to find vapor migration pathways into a structure or around a structure, such as utility corridors. The composition of subsurface soil vapors can be determined from passive soil vapor samples, and the location of potential source areas and subsurface plumes can be mapped, particularly edges of plumes to determine whether contamination is near current or future buildings. Passive soil vapor sampling methods can also be useful in situations where active methods may not be applicable, e.g., low-permeability areas and high-moisture settings. Further, they are capable of detecting and reporting compounds present in very low concentrations.

Special considerations for passive soil vapor surveys include the following:

- The adsorbent material should be hydrophobic to minimize water vapor uptake.
- Exposure time: The sampler must be deployed long enough to adsorb a detectable mass, but not so much as to allow the adsorbent to become saturated.
- Desorption and analytical method: The adsorbed compounds can be removed from the adsorbent by thermal desorption or solvent extraction and analyzed using

gas chromatography (GC) or GC-mass spectrometry (GC/MS). Methods using thermal desorption have the benefit of greater method sensitivity than those using solvent extraction.

- **Sampler installation:** For subslab sampling, a narrow-diameter hole is drilled through the slab, and the sampler is slipped into the hole beneath the slab, while the hole itself is sealed.

Deeper soil vapor sampling generally involves drilling a narrow-diameter hole at least 3–5 feet bgs. The passive sampler is inserted to depth and the installation hole is secured.

- **Passive samplers** should be transported in a sealable container to preserve cleanliness prior to use and to prevent additional adsorption during return shipment to the analytical laboratory (ITRC, 2007).



Figure 6.20 Installation of a passive soil vapor sampler (Beacon-USA.com)

The person in Figure 6.20 has several samplers to install. He will install them in a gridded pattern, leave them in place for approximately two weeks and then come back to collect them for chemical analysis. Figure 6.21 details a typical map created from the results of a passive soil vapor survey.

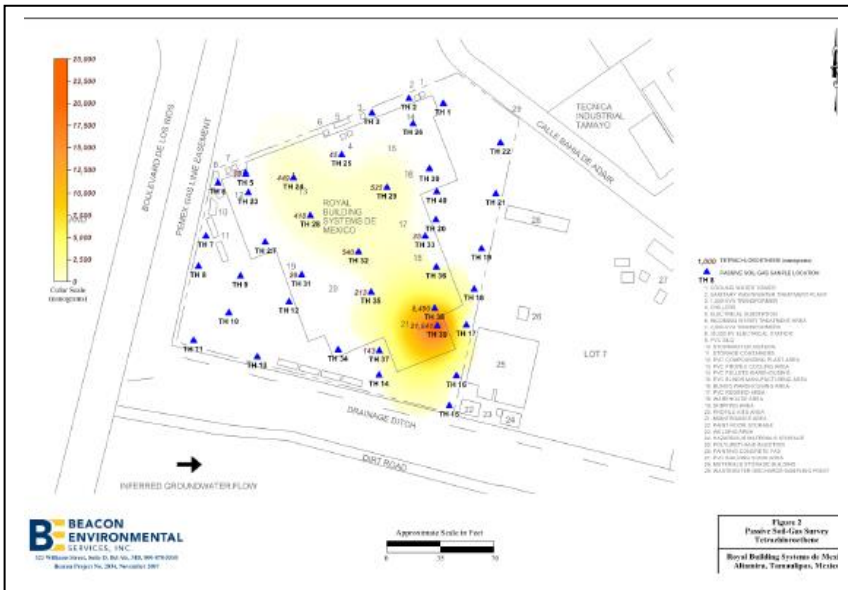

Figure 6.21 Passive Soil Vapor Survey Map (Beacon-USA.com)

A map created from the results of a passive soil vapor survey. The blue triangles represent sample locations. The bright orange area represents a potential contamination source area.

6.2.3 Applying Soil Vapor Survey Sample Results

Soil vapor sampling results can be applied in two ways and are dependent on DQO's. Soil vapor sampling results can be applied qualitatively or quantitatively. Qualitative results are when one sample result is compared to another result (e.g. source area search). Quantitative results are used when comparing to regulatory standards (e.g. collecting vapor inhalation data for risk assessment issues). Quantitative applications have DQOs with more stringent QA/QC requirements. Passive soil vapor survey results are always qualitative.

Soil vapor surveys can be utilized during several stages of an investigation. Many of these are listed in Table 6.6 below:

Table 6.7 – Applying Soil Vapor Sample Survey and Their Results

Soil Vapor Sampling Applications and Results Category	
Application	Category
Confirm releases to the environment	Qualitative/Quantitative
Identify source areas and release locations of VOCs/SVOCs	Qualitative
Identify potential soil sampling locations	Qualitative
Identify vapor migration routes	Qualitative
Focus remediation efforts	Qualitative
Track remedial progress	Qualitative/Quantitative
Gather data for risk assessment regarding vapor inhalation issues	Quantitative

Qualitative – QA/QC not as stringent. Used to compare one soil vapor survey result to another.
 Quantitative – QA/QC more stringent. For use when comparing to standards.

DQO's will vary with both the stage of investigation and the intended use of the data collected from soil vapor sampling. During screening or the initial stages of investigation, DQOs will be less stringent than those for confirmation of remediation or risk assessment regarding vapor inhalation issues. DQO's will determine the sampling method, the type of sample collected, the frequency of sample collection, sampling location, the number of samples to be collected, and the specific QA/QC necessary, both in the field as well as in the laboratory.

6.2.3.1 Use of the Three Phase Partitioning Equation

A.A.C. R18-7-203(C) allows soil vapor samples to estimate the total contaminant concentration in soil if the Department determines that the soil vapor concentration methodology will not be invalidated by the soil, hydrogeology, or other characteristics of the site. Converting soil vapor concentrations to total contaminant concentrations for the purpose of comparing against cleanup standards should be done with great care and only if the site is well characterized and investigations have the proper DQO's. ADEQ's [Soil Vapor Sampling Guidance](#) provides a method, the three-phase partitioning equation, for

converting soil vapor concentrations to total contaminant concentrations. The [GPL Spreadsheet](#) includes a tab with a partitioning equation to conduct the conversion.

For the identification, characterization and tracking remedial progress of vadose zone VOC sources, including PCE, TCE, and their degradation products, soil vapor sampling is recommended over soil solid sampling for the following reasons:

- **Heterogeneity and Representative Sample Volume**

The distribution of vadose zone contamination usually has high spatial variability. Total concentrations of VOCs may vary greatly over short distances due to heterogeneities in soil texture, structure, grain-size distribution, moisture content, and organic carbon content. Due to the nature of soil sampling and sub-sampling procedures, the volume of a soil solid sample is very small compared to the total volume of vadose zone subject to investigation. Consequently, it is unlikely that soil solid sample represents an average bulk concentration in the vicinity of the boring for any given depth. In contrast, soil-vapor samples represent a relatively larger volume of the vadose zone providing an average concentration for the area of concern as a result of VOC vapor diffusion and equilibration in the vicinity of a release.

- **Sampling and Mass Loss**

Since a significant fraction of the total concentration in a soil matrix sample may be in the vapor phase, some loss of contaminant mass is inevitable during sample collection, preparation, and analysis despite improvements in soil sampling protocols. In contrast, vapor samples may be collected and injected directly into a gas chromatograph from the sample container with no exposure to the atmosphere.

- **Total Concentrations and DNAPL**

Soil vapor analytical results may be used to calculate total concentrations in soils, using equilibrium partitioning equations, when soil physical and chemical properties are known or default parameters are used such as in [GPL](#) and SRL calculations. This calculation may provide a minimum concentration if DNAPL is present as the equation does not account for pure-phase liquid. The equation is based on a standard soil partitioning equilibrium model which assumes that a fourth phase (i.e. NAPL) is not present. An investigation and determination of whether or not residual NAPL is present in the soil column should be made prior to making a decision to utilize the three-phase partitioning equation.

However, the presence of DNAPL may be inferred from high vapor concentrations (see Table 6.6). In contrast, soil solid samples may easily miss DNAPL contamination for the reasons outlined in the “Heterogeneity and Representative Sample Volume” and “Sampling and Mass Loss” portion of this section.

- **Analytical Results and Reproducibility**

Soil vapor data is easily used in vadose zone transport models to determine if vadose zone contamination presents a threat to the underlying aquifer, and if so, when the vadose zone is clean enough to terminate remedial activities.

When soil vapor monitor wells are installed, the vadose zone may be resampled to provide a check against previous vapor sampling and analytical results. Soil vapor samples, as well as vacuum measurements, may be collected periodically from vapor monitor wells to monitor the progress and effectiveness of on-going remediation activities such as SVE. In contrast, it is difficult to routinely collect time-series soil solid samples for comparison.

If a vapor monitor well network were established to track remedial progress and, ultimately, confirm that soil remediation is complete, comparisons of co-located soil solid and soil vapor samples at each monitoring location should be completed during the investigative process to validate the use of the three-phase partitioning equation.

For these reasons, at sites with VOC releases, soil vapor sampling may provide a more accurate method than soil matrix sampling to estimate the concentration of a contaminant in the vadose zone. Once the site is adequately characterized, concentrations of soil vapor data can be used to determine if the concentrations of contaminants remaining in the soil are protective of aquifer water quality as well as compared to SRLs to be protective of human health.

6.2.3.2 Soil Solid Versus Soil Vapor Sampling - an example

Figure 6.22 is a scenario where different conclusions were made based upon the type of sample collected and analyzed. In the first situation, soil solid samples were collected and analyzed. The conclusion was that there was no release of regulated substances into the environment at the site. In the second situation, soil vapor samples were collected and analyzed. The conclusion was that there was a release into the environment.

Good news Ms. Facility Owner – no contamination.
 You are good to go! We have no idea why the people next
 door are complaining about odors, but your facility is
 certainly not the cause of any odors.

**Example of an inappropriate
 investigative technique.**

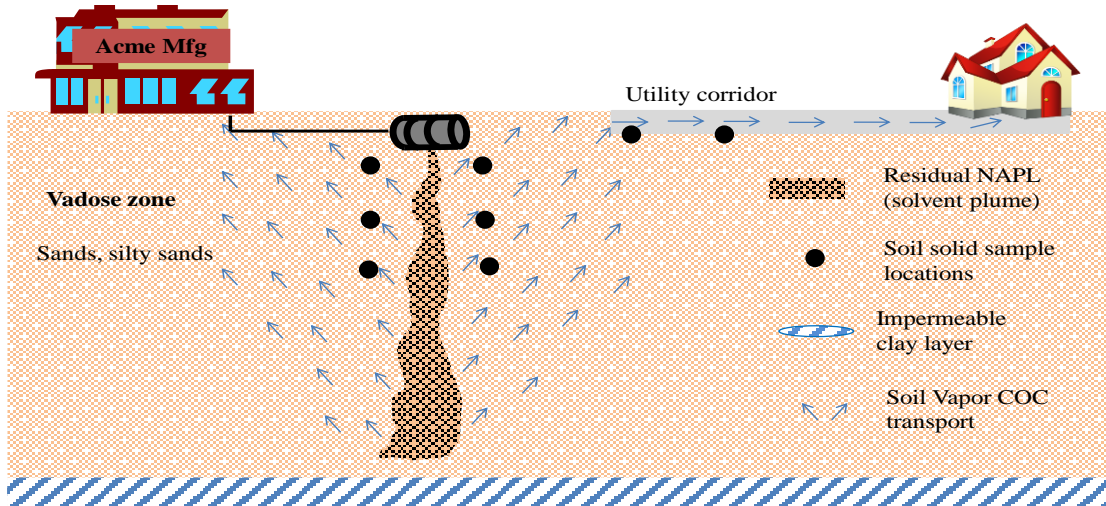

Well, Ms. Facility Owner, we have detected contamination in the subsurface. You will want to perform a check on your equipment to see if there is an ongoing release/leak in your system. Also, because we used the Triad Approach for this investigation, we have collected enough information - with the proper QA/QC measures - to determine whether or not the contamination in the subsurface poses an unacceptable risk to human health and the environment. We will have these results analyzed by our risk assessor.



**Example of an appropriate
 investigative technique.**

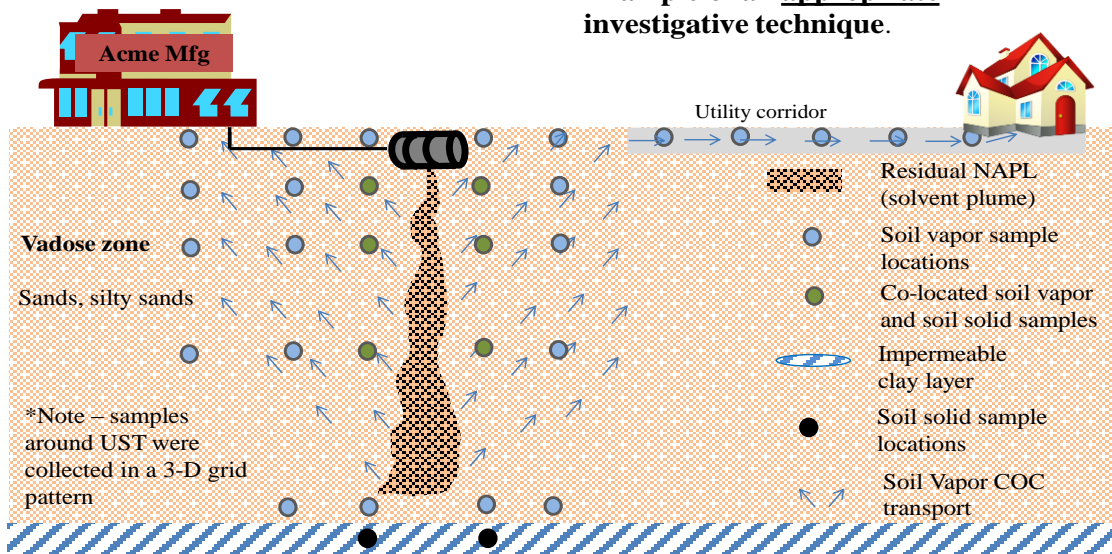

Figure 6.22 Different Sample Types, Different Conclusions. Different sample types collected can lead to different conclusions. In this scenario, a comparison of conclusions with regards to soil solid versus soil vapor sampling is made.

6.2.4 Reference Websites

[Information on direct push installation methods](#)

[Chapter 9 of New Jersey DEP Field Sampling Procedures – Soil Gas Survey](#)

[Appendix D.5 of ITRC January 2007 Vapor Intrusion Pathway: A Practical Guideline](#)

[Passive Soil Gas Surveys – Beacon Environmental Services website](#)

6.2.5 Other Reference Used

New Jersey Department of Environmental Protection, 2005, Field Sampling Procedures Manual. Chapter 9 – Soil Gas Surveys.

Hyperlink:

<http://www.nj.gov/dep/srp/guidance/fspm/>

Important Information You Should Know after Reading Section 6.3 – Groundwater Sampling:

1. [Aquifer types.](#)
2. [Primary fate and transport mechanisms for contaminants in groundwater.](#)
3. [Considerations for monitor well installation.](#)
4. [Considerations for monitor well placement.](#)
5. [Different types of measurements and sampling techniques.](#)

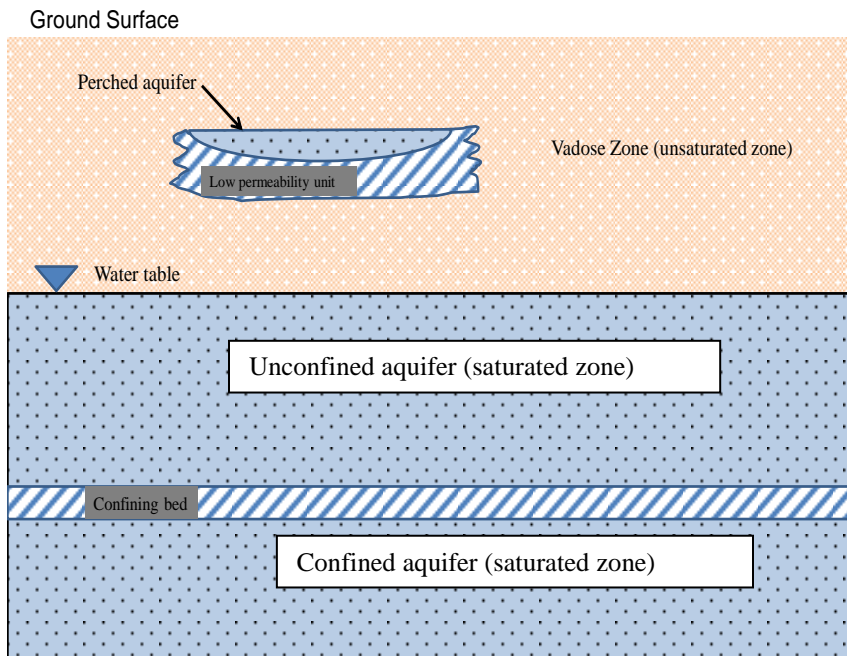
<p>The four main aquifer types:</p> <ol style="list-style-type: none"> 1. Perched; 2. Unconfined; 3. Confined; and 4. Leaky artesian* <p>*A leaky artesian aquifer is basically a confined aquifer except that the low-permeability confining bed allows water to slowly flow through it.</p>  <p>The diagram illustrates the subsurface geology. At the top is the Ground Surface. Below it is the Vadose Zone (unsaturated zone). Within this zone, there is a Perched aquifer above a Low permeability unit. Below the water table (indicated by a blue triangle) is the Unconfined aquifer (saturated zone). Below this is a Confining bed, and at the bottom is the Confined aquifer (saturated zone).</p>	<p>Primary fate and transport mechanisms for contaminants in groundwater:</p> <ol style="list-style-type: none"> 1. Advection – the process by which moving groundwater carries with it dissolved contaminants. This is the main form of contaminant migration in groundwater 2. Dispersion – the process by which contaminants in flowing groundwater is mixed with uncontaminated water and becomes reduced in concentration. 3. Diffusion – the process by which dissolved contaminants move from areas of higher contaminant concentration to areas of lower contaminant concentration. 4. Anthropogenic (human-made) Influences – pumping wells, artificial recharge, irrigation, and changes in land use patterns (e.g., paving and construction) can alter flow beneath a pollution source either continuously or intermittently. Other structures that can influence flow include, but are not limited to, infiltration galleries, storm sewers, sanitary sewers, utility lines, underground piping, and drainage tiles. <p>Contaminant characteristics affecting fate and transport:</p> <ol style="list-style-type: none"> 1. Relative Solubility – is a measure of a contaminants ability to dissolve. Some contaminants dissolve more readily than others. 2. Fluid Density – the mass of fluid per unit volume (g/cm³). DNAPLs are denser than water. LNAPLs are less dense than water. 3. Kinematic viscosity – the ratio of dynamic viscosity to density. Dynamic viscosity provides an indication of the ease with which a compound (in its pure form) will flow. Lower kinematic viscosity results in greater tendency to penetrate a porous media. 4. Sorption - the interaction of a contaminant with the porous media, which can result in retarding the movement of a contaminant. 	<p>Considerations for monitor well installation:</p> <ol style="list-style-type: none"> 1. The Arizona Department of Water Resources (ADWR) website details well construction requirements. 2. Wells installed in Active management Areas (AMAs) of the state have additional requirements. 3. The presence of confining units should be considered during well installation. 4. Historical and yearly groundwater table elevation changes should be considered during monitor well installation. <p>Considerations for monitor well placement:</p> <ol style="list-style-type: none"> 1. The density of sampling points in a monitoring network will depend on the geology and hydrology, the spatial scales at which contaminant distribution varies horizontally, vertically and temporally, and the desired level of confidence in the evaluation. 2. The use of a transect-based approach to monitoring may greatly reduce the uncertainty in performance monitoring evaluations at many sites by improving the definition of contaminant distribution and its variability. 3. The typical target zones for contaminant plume monitoring are: 1) source areas; 2) transmissive zones; 3) distal portions of the plume; 3) plume boundaries; 4) “recalcitrant” zones; 5) background areas outside of contaminant plume.
<p>Well purging techniques:</p> <ol style="list-style-type: none"> 1. Low-flow purging; 2. Well-volume approach; and 3. Low permeability formation procedures. 	<p>Groundwater sample collection methods:</p> <ol style="list-style-type: none"> 1. Low-flow approach; 2. Submersible pump sampling; 3. Peristaltic pump sampling; 4. Bailer sampling; and 5. Passive diffusion bags 	<p>Importance of Monitoring:</p> <ol style="list-style-type: none"> 1. Provides timely warning of impact to receptors; 2. Warns of possible plume expansion, 3. Detects geochemistry changes. 4. Detects changes in plume size; 5. Determines temporal variability of data; and 6. Tracks remedial progress.

6.3 Groundwater Sampling

Several definitions of groundwater exist in literature. Each describes groundwater in similar ways. Two of these definitions are listed below:

- 1) The water contained in interconnected pores located below the water table in an unconfined aquifer or located in a confined aquifer.
- 2) Water that collects or flows beneath the Earth's surface, filling the porous spaces in soil, sediment, and rocks. Groundwater originates from rain and from melting snow and ice and is the source of water for aquifers, springs, and wells. The upper surface of groundwater is the water table.

A.A.C. R18-12-101 defines groundwater as water in an aquifer. A.R.S. 49-201 defines an aquifer as meaning a geologic unit that contains sufficient saturated permeable material to yield usable quantities of water to a well or spring.

Investigation for full extent and distribution of groundwater contamination is required for regulated substances that impact groundwater. The investigator should conduct a groundwater investigation if data, compiled in the continuous development of the CSM, suggests that the groundwater is or may potentially be impacted. The following conditions should be considered when deciding if a groundwater investigation is necessary:

1. Soil investigations indicate that contamination has migrated to a close proximity of historic high groundwater (please note that the term “close proximity” is not meant to be an exact distance, the distance is based on site specifics);
2. Sites where soil contamination may have naturally attenuated so that there is no representative soil or soil vapor data to indicate that groundwater was not affected by a release to the environment (Figure 6.23) (e.g. closed facilities where investigative activities occur well after operations cease);
3. The soil at the source area has a relatively high permeability, or little sorptive capacity;
4. Potential receptors may have been impacted by contaminants at and/or emanating from the site (i.e., potable wells, occupied structures, or surface water); and
5. The potential discharge is close to or beneath the water table. For example, when investigating an underground storage tank (UST), leach field or seepage pit near a shallow water table.

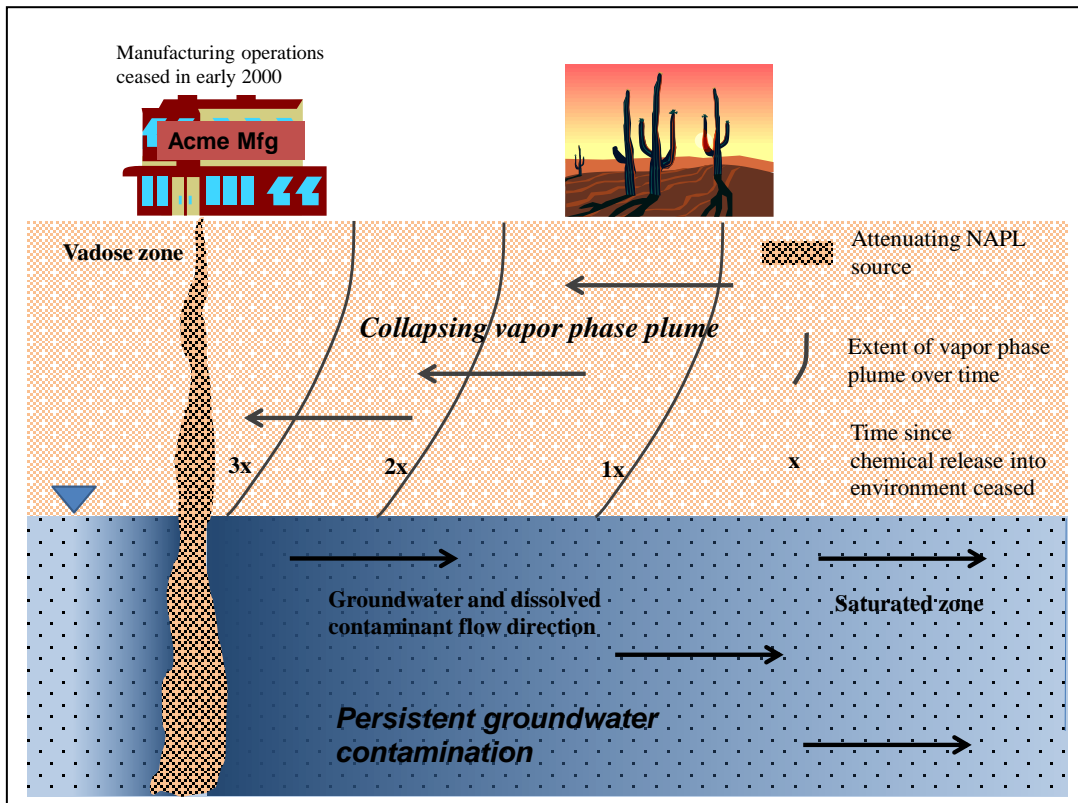

Figure 6.23 Radial vapor diffusion at three different time intervals after chemical releases into the environment ceased.

6.3.1 Aquifer Types

There are four types of aquifers (Figure 6.24): unconfined, confined, perched, and leaky confined. Each is defined below followed by a simple pictorial of the first three. Monitor well construction (Section 6.3.3) considerations for these different types of aquifers play an important role in groundwater investigations.

- 1) An **unconfined aquifer** is an aquifer in which there are no confining beds between the zone of saturation and the surface. There will be a water table in an unconfined aquifer. Water-table aquifer is a synonym.
- 2) A **confined aquifer** is an aquifer that is overlain by a confining bed. The confining bed has a significantly lower hydraulic conductivity than the aquifer (e.g. the aquifer is composed of sands while the confining bed is composed of clays). If a well was installed into the confined aquifer with the screened interval below the confining bed, the water level in the well would rise above the confining layer.
- 3) A **perched aquifer** is a region in the unsaturated zone where the soil is locally saturated because it overlies a low-permeability unit.

- 4) A **leaky artesian or leaky confined** aquifer is a semi-confined aquifer. This type is basically a confined aquifer except that the low-permeability confining bed allows water to slowly flow through it. Synonyms for this type of aquifer are leaky artesian or leaky confined aquifer.

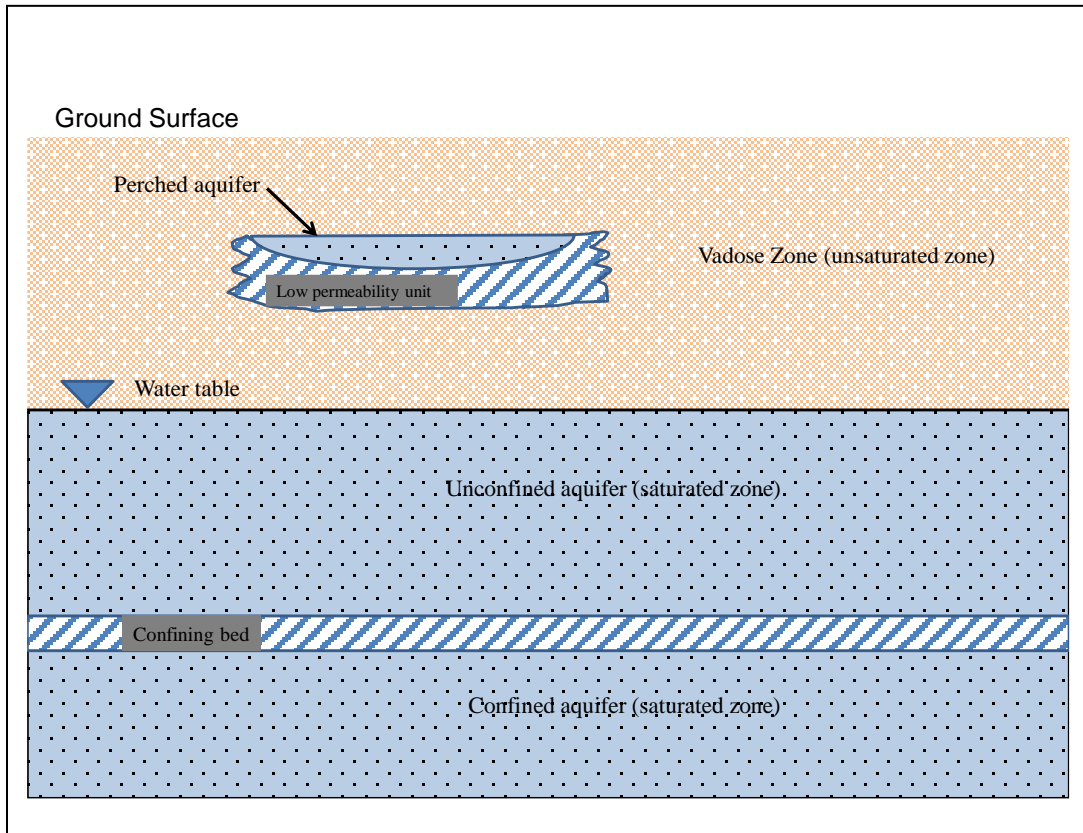

Figure 6.24 Aquifer Types. Simple pictorial of three of the four base types of aquifers. There is no hydraulic communication between the depicted confined and unconfined aquifers.

6.3.2 Groundwater Contaminant Transport

Several physical mechanisms describe the transport of contaminants through groundwater systems. Those mechanisms are molecular advection, diffusion and dispersion. Chemical characteristics of the contaminants (dissolved phase and non-aqueous phase liquids) also play a role in their transport through groundwater. Some of those characteristics are relative solubility, fluid density, kinematic viscosity, and potential for sorption, reaction and degradation. Multiple plumes can form if a combination of contaminants with different properties is present.

6.3.2.1 Processes Controlling the Movement of Dissolved Contaminants

Advection:

Advection is the process by which moving groundwater carries with it dissolved contaminants. The process moves contamination from one area to another. This is the main form of contaminant migration in groundwater. Advective flow velocities are based on the average (bulk) properties of the aquifer materials and the average hydraulic gradient causing flow (see Section 6.3.4.2 for discussion on hydraulic gradient). Advective flow velocity is greater in more permeable aquifers and when the average hydraulic gradient is large. Darcy's Law is the basis for quantifying the rate of fluid flow through a saturated zone. This simple approach does not take into other processes (e.g. diffusion, dispersion and retardation factors), which can increase or decrease the rate of dissolved contaminant flow calculated by advection.

Dispersion and Diffusion:

Dispersion is the process by which contaminants in flowing groundwater is mixed (i.e., contaminant mass is spread out in a larger volume of groundwater) with uncontaminated water and becomes reduced in concentration. Diffusion is the process by which dissolved contaminants move from areas of higher contaminant concentration to areas of lower contaminant concentration. Diffusive flow occurs on a molecular scale and is concentration dependent. Diffusion will occur regardless of whether advective flow is occurring. The dispersion and diffusion processes cannot be distinguished in a groundwater flow system and often are referred to collectively as *hydrodynamic dispersion* (Fetter, 2001). Hydrodynamic dispersion may cause contaminants to arrive at a given location significantly ahead of the arrival time expected solely from advective flow. Figure 6.25 compares contaminant flow from a continuing contaminant source and a one-time spill source.

Probably the most memorable image of the advection and hydrodynamic dispersion processes is smoke coming from a chimney or smokestack. On a dry, windy day the smoke plume will be long, thin and appear more transparent at the edges of the plume. This situation is akin to a permeable aquifer with a large hydraulic gradient (i.e. the contaminant plume will travel quickly downgradient, but will not spread in a transverse direction a great deal). If the wind is very light on that same day, the smoke plume will be shorter, bulkier and gradually gain more transparency towards the edges of the plume. This situation is akin to the same permeable aquifer except with a much smaller hydraulic gradient (i.e. the contaminant plume will not travel quickly downgradient, but will spread in a transverse direction a great deal). In the first scenario, the advection process plays a greater role in contaminant transport than in the second scenario. In the second scenario, the dispersion process plays a greater role in contaminant transport than in the first scenario.

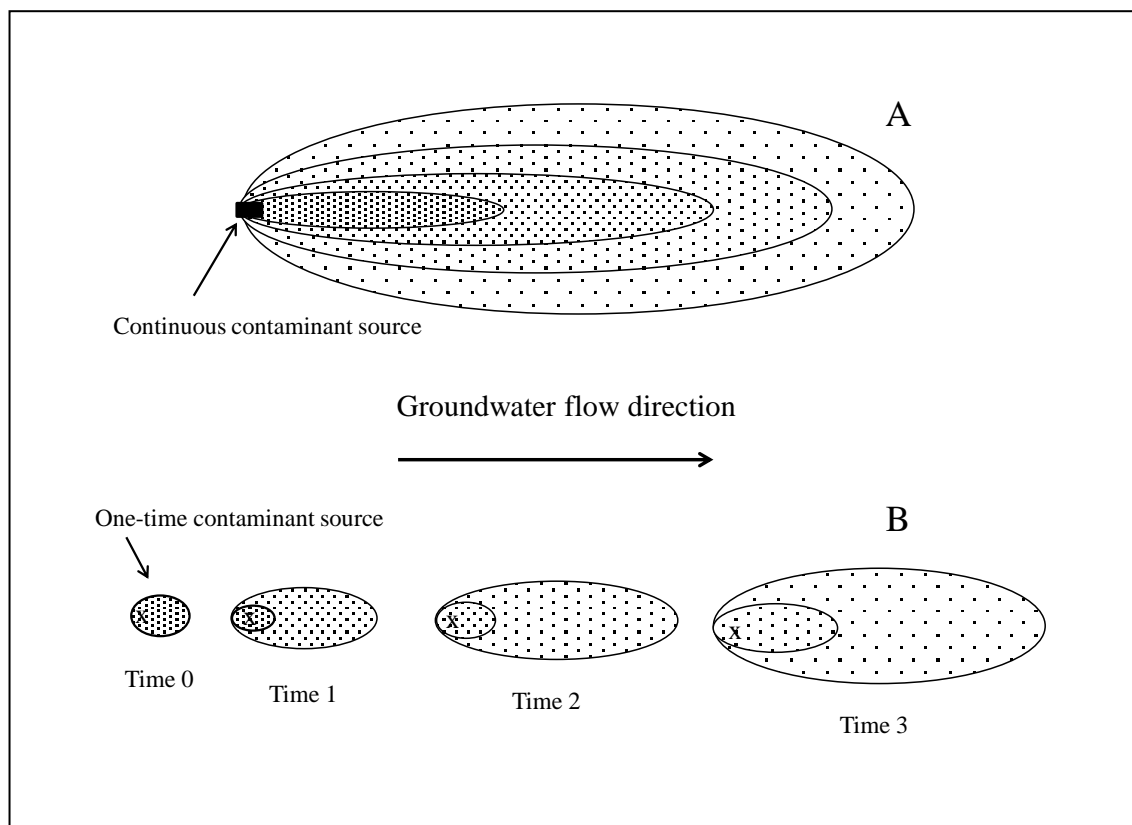

Figure 6.25 Contaminant Dispersion in Contaminant Plumes. Idealized contaminant plume development from a continuous source (A) and a one-time contaminant spill (B). Denser stipple represents greater contaminant concentration. Advection and hydrodynamic dispersion are the only processes affecting this depiction. The “x” in B represents one location in the aquifer. Please note that the spread of contamination is greater in the direction of groundwater flow than the transverse direction (modified from Fetter, 1988).

6.3.2.2 Contaminant Characteristics Affecting Fate and Transport

Relative Solubility:

Solubility is a measure of a contaminant's ability to dissolve. Some contaminants dissolve more readily than others. Relative solubility controls whether a contaminant exists in groundwater primarily as a dissolved (soluble) or free liquid phase (insoluble).

Fluid Density:

Fluid density is defined as the mass of fluid per unit volume (g/cm^3). If a contaminant is denser than groundwater, it tends to sink and may accumulate as a DNAPL (see Figure 6.26). Conversely, a contaminant less dense tends to remain in the upper portions of saturated zones as a LNAPL. Most LNAPLs are hydrocarbon oils and fuels and DNAPLs include chlorinated compounds (e.g., carbon tetrachloride, PCE, PCBs) and creosote.

Density:

The density of a contaminant, in conjunction with its relative solubility, affects the shape and disposition of the dissolved and free phase plume(s). Individual contaminants can be classified based on relative solubility and density as: 1) high density and relatively soluble; 2) low density and relatively soluble; 3) low density and relatively insoluble; or 4) high density and relatively insoluble (Figure 6.26). Relatively soluble contaminants are generally mobile in the subsurface and can form large dissolved plumes with relatively small free phase plumes. If a contaminant is a dense, soluble liquid, the plumes that form may cover the entire thickness of the saturated zone. Likewise, if a contaminant is soluble but of low density, the major portion of the plume will be limited to the upper portions of the saturated zone. The depth of the dissolved phase would be dependent on the vertical flow component.

DNAPLs/LNAPLs:

Relatively insoluble liquids can exist as large free liquid plumes with relatively small dissolved plumes. DNAPLs tend to migrate vertically and coalesce at the surface of a confining layer, their movement dictated by the dip of the confining layer. In some cases, DNAPLs may migrate in a direction that does not correspond to the direction of groundwater flow. LNAPLs generally migrate on top of the capillary fringe/water table and have an underlying halo of dissolved substance. Identifying whether or not a compound exists as DNAPL or LNAPL can be complicated by the substance in which it is dissolved. For example, free phase PCBs may be denser than water, but PCBs in oil can be transported as an LNAPL. The presence of DNAPL can be inferred by interpreting chemical analysis (see Table 6.6). A “rule of thumb” is that you can infer DNAPL presence with concentrations of DNAPL chemicals in groundwater at concentrations greater than 1% of the pure phase solubility or effective solubility. For example, PCE solubility is 200,000 µg/l, concentrations above 2,000 µg/l may indicate that DNAPL is present.

Kinematic Viscosity:

Kinematic viscosity of a non-aqueous phase liquid (NAPL) provides an indication of the potential for the compound (in its pure form) to percolate through the subsurface. Kinematic viscosity is the ratio of dynamic viscosity to density. Dynamic viscosity provides an indication of the ease with which a compound (in its pure form) will flow. Lower kinematic viscosity results in greater tendency to penetrate a porous media. In general, mobility can be rated high if the value is less than 0.4 centistokes (cs), moderate if between 0.4 and 0.8 cs, and low if greater than 0.8 cs (EPA, 1992). The kinematic viscosity of water is approximately 1 cs. The relative viscosity of a NAPL indicates how fast it penetrates the subsurface relative to water. For example, tetrachloroethene, 1,1,1-trichloroethane, methylene chloride, chloroform, and carbon tetrachloride (low kinematic viscosity) flow 1.5 to 3 times as fast as water, while light heating oil, diesel fuel, jet fuel, and crude oil (high kinematic viscosity) flow 2 to 10 times slower than water (Schwille, 1988; Huling and Weaver, 1991). The relative permeability of a material can be one or more orders of magnitude higher when low viscosity fluids are moving through it than for water moving through the same material. A low viscosity LNAPL such as gasoline tends to spread on the capillary fringe/water table surface more readily than would a LNAPL of

high viscosity. A DNAPL more viscous than water tends to move more slowly than the average linear velocity of groundwater.

Section 7.1 of this document contains a table listing solubility values for selected chemicals.). Please visit <http://epa.gov/region9/superfund/prg/> for most current values.

Reactions and Degradation:

Sorption processes include adsorption, chemisorption, absorption and ion exchange. It is not the intent of this document to define or separate these phenomena. Sorption reactions between solutes and the geologic matrix can retard the movement of a "reactive" solute. From a practical viewpoint, the important aspect is the removal of the solute from solution, irrespective of the process (Fetter, 1999). For example, many heavy metals (e.g., cadmium, lead, and mercury) are adsorbed readily onto particle surfaces or trapped by clays through ion exchange. Adsorption of metals generally increases with increasing pH, although exceptions occur. Synthetic organic compounds in solution can be adsorbed by the organic carbon in soil.

The rate and extent of adsorption depends on the characteristics of the adsorbing agent and the chemicals and the phases in which the chemicals exist. The process by which a contaminant that was originally in solution becomes distributed between the solution and the solid phase is called partitioning. The partitioning coefficient (K_d) is used to evaluate the effect of sorption on the retardation of an organic chemical compared with the rate of movement of groundwater. The expression: $R = 1 + rK_d/n$, where R is the retardation factor that quantitatively expresses the ratio of velocity of water to velocity of the chemical, r is the bulk density and n is the porosity of the subsurface material, defines K_d . Other parameters that may be useful in predicting extent of adsorption of an organic constituent include the octanol-water partitioning coefficient (K_{ow}) and the organic carbon absorption coefficient (K_{oc}). The higher the value of K_{ow} and K_{oc} , the greater the tendency for adsorption to soils containing appreciable amounts of organic carbon. Please see Section 7.1 for further explanation of these processes.

Chemical reactions and biological and chemical degradation of a contaminant may form new compounds. For example, TCE degrades to dichloroethene (DCE) and subsequently to vinyl chloride. The properties of both the original contaminant and its degradation products should be considered. Degradation in the subsurface may not always be predicted merely from the known behavior of compounds.

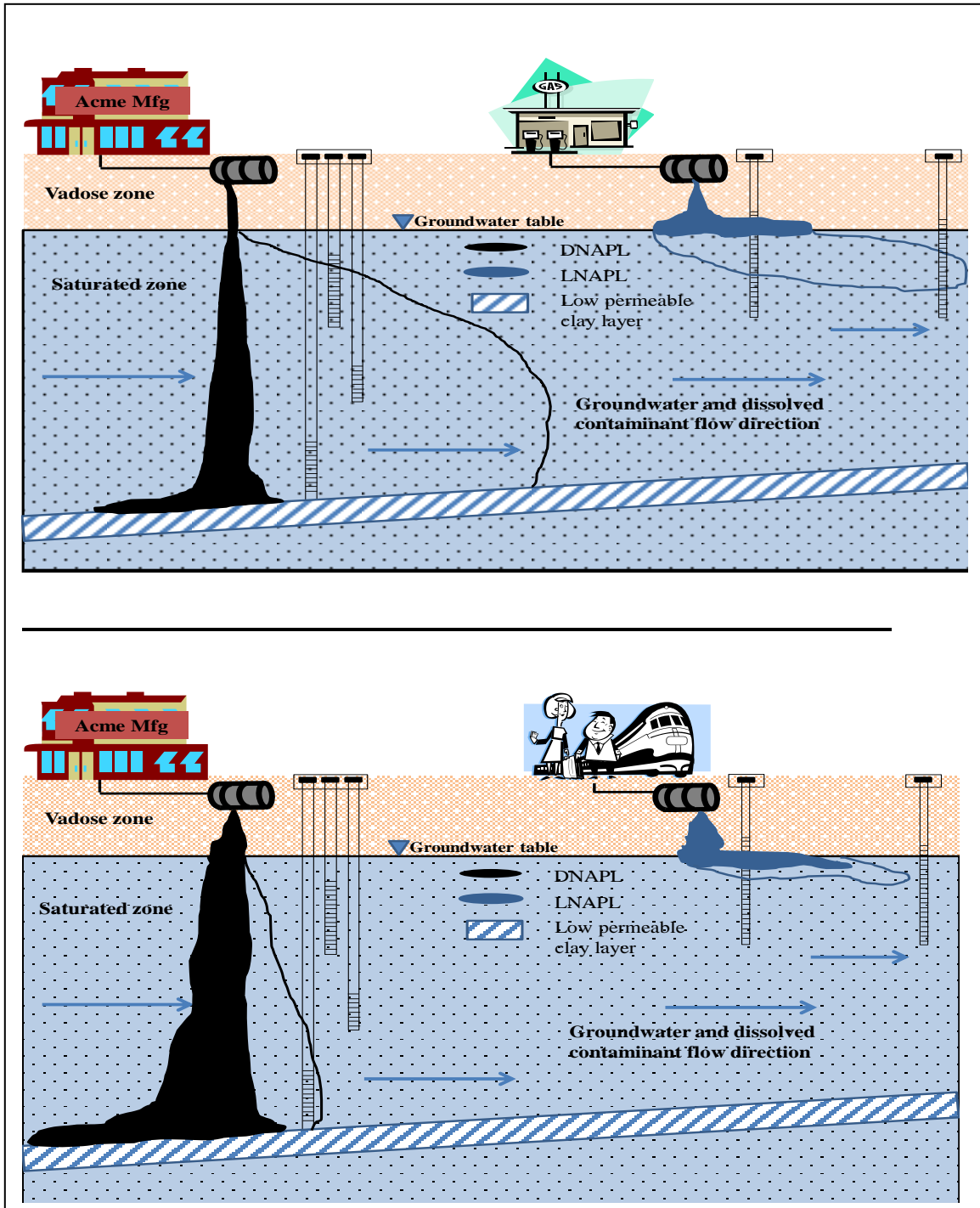

Figure 6.26 Chemical Properties Effect on Flow & Transport of Contaminants. Simplified depiction of how chemical properties affect flow and transport in groundwater. Top diagram - Release of high and low density chemicals and relatively soluble contaminants (e.g. TCE and gasoline); and Bottom diagram - Release of high and low density chemicals and relatively insoluble contaminants (e.g. PCE and railroad diesel). Please note that TCE is 5.5 times more soluble than PCE.

Anthropogenic Influences:

Anthropogenic (human-made) influences can alter groundwater flow direction and thus dictate contaminant pathways. Pumping wells, artificial recharge, irrigation, and changes in land use patterns (e.g., paving and construction) can also alter flow beneath a pollution source either continuously or intermittently. Other structures that can influence flow include, but are not limited to, infiltration galleries, storm sewers, sanitary sewers, utility lines, underground piping, and drainage tiles. In addition, overhead power lines, road, and other structures may make areas not accessible for the placement of wells.

6.3.3 Well Construction

The Arizona Department of Water Resources (ADWR) is the Arizona regulatory agency that provides oversight of well construction and licensing of drillers. ADWR published [“Statutes and Rules Governing Minimum Well Construction Standards and the Licensing of Well Drillers”](#) in 2011. This document compiles all the Arizona Revised Statutes and Arizona Administrative Code regarding well construction standards and well driller licensing into one document.

Some of the [statutes](#) pertaining to water quality at ADWR are listed below. Please note that ADEQ plays an important role in these statutes:

1. A.R.S. § 45-105 – Powers and duties of director - Describes the duties of the director to coordinate, confer, and contract with the department of environmental quality in matters pursuant to title 49, chapter 2, article 5, Remedial Actions.
2. A.R.S. § 45-594 - Well construction standards; remedial measures – Establishes statutory authority of the director to establish well construction rules.
3. A.R.S. § 45-596 – Notice of intention to drill - Describes requirements for filing a notice of intent to drill or deepen a well.
4. A.R.S. § 45-596(I) – Defines remedial action sites.
5. A.R.S. § 45-596(J) – Establishes licensing timeframe of 45 days for review of notices of intent for wells within or near remedial action sites.
6. A.R.S. § 45-605 – Well inspections; cross-contamination; remedial measures; definition – Establishes the authority for director to inspect wells for vertical cross-contamination of groundwater, and conduct remedial actions in consultation with the director of environmental quality.
7. A.R.S. § 45-605(E) - Requires the director to notify persons drilling a well in a sub-basin where a registry site is located and gives the authority to establish rules for new and replacement wells.
8. A.R.S. § 45-618 – Arizona water quality fund – Establishes the Arizona water quality fund as a means for ADWR participation in WQARF activities and prescribes reporting requirements.

6.3.3.1 Monitor Well Construction Requirements

ADWR recommends that Notices of Intent include a detailed well construction diagram that depicts the major well construction materials and specifications. A detailed [monitor well construction diagram](#) is **required** for monitoring well permit applications in [Active Management Areas](#). Well construction diagrams should indicate the following features:

- Borehole Depth
- Borehole Diameter
- Casing Material (steel or thermoplastic)
- Casing Length and Diameter
- Width of Annular Space between the casing and the borehole
- Surface Seal (20-feet of steel casing from one foot above ground level. The seal shall be cement grouted from bottom of zone to land surface).
- When inner and outer casings are installed, the annular space between the casings shall be completely sealed. (*e.g. when installing wells below a confining unit*)
- Access Port
- Annular Material (specific type of grout and gravel pack)
- Expected Depth to Water
- Screening Materials and Perforated Intervals (in feet)

[A.A.C. R12-15-811](#) lists minimum well construction requirements. A.A.C. R12-15-811(H) states for monitor wells:

- A monitor well may be screened up to ten feet above the highest seasonal static water level of record for the purpose of monitoring contaminants; and
- A monitor well shall be identified as such on the vault cover or at the top of the steel casing. Identification information shall include the well registration number.

6.3.3.2 Special Well Construction Requirements

ADWR has special well construction requirements that may apply to any proposed well to be drilled or modified when special aquifer conditions exist, such as a well within or near a [remedial action site](#). Arizona minimum well construction standards sometimes are not protective of the aquifer when there is groundwater contamination nearby. To be protective of the aquifer from existing contamination or potential contamination, special well construction requirements are employed to eliminate vertical cross-contamination within an aquifer or between aquifers and minimize the potential migration of a contaminant plume resulting from groundwater withdrawals.

Remedial Action Sites are contaminant sites in Arizona being investigated and remediated under the following Arizona and federal environmental programs:

- ADEQ's Water Quality Assurance Revolving Fund Program (WQARF; including mitigation of non-hazardous releases)
- Comprehensive Environmental Response, Compensation, and Liability Act (CERCLA, also known as Superfund)
- U.S. Department of Defense (DOD) Installation Remediation Program (IRP)
- ADEQ's Leaking Underground Storage Tank (LUST) program
- ADEQ's Voluntary Remediation Program (VRP)
- ADEQ's Hazardous and Solid Waste Programs (Resource Conservation and Recovery Act, RCRA)

Buffer zones around remedial action sites have been prescribed by state statute and rule to delineate the entire boundaries within which additional technical review of Notices of Intent to Drill and Well Permits is required by ADWR. The statute and rule prescribes a one-mile buffer around WQARF, CERCLA, and DOD IRP sites, a one-half mile buffer around VRP and RCRA sites, and a 500 feet buffer around LUST sites.

Site-specific special well construction requirements have been developed for several remedial action sites in Arizona, and can be downloaded below. This page should be reviewed before filing a Notice of Intent to drill a well or when drilling in or near a remedial action site.

1. [Special Well Drilling Requirements](#) (For Wells Located Within Areas of Ground Water Contamination) finalized November 1, 2002
2. [Special Well Construction and Abandonment Procedure for Pinal Creek](#) Water Quality Assurance Revolving Fund Site finalized March 30, 2007
3. [Special Well Construction and Abandonment Procedure for Yuma Marine Air Corps Station](#) CERCLA Site, finalized October 2002

6.3.3.3 Monitor Well Installation Vertical Cross Contamination Considerations

During all sites investigations, it is important to take steps to limit the potential for [vertical cross contamination](#) (Figure 6.27). Drilling through confining units should be avoided if the presence of DNAPL or a downward vertical head between the upper and lower aquifers is suspected. Also, drilling through perched aquifers should be avoided where there is the potential for cross contamination of the underlying units. Where it is necessary to drill through a confining unit to complete vertical delineation of groundwater contamination, wells should be double cased and completed outside of areas where NAPL is suspected.

6.3.3.4 Other Monitor Well Installation Considerations

Groundwater table elevation changes:

Historical information regarding groundwater conditions is key to a complete groundwater investigation. Prior to conducting field operations, the investigator should establish an historic high and low groundwater level utilizing local and regional information. For instance, if LUST releases are located in the area, that LUST case file may contain years of groundwater table elevation data.

Figure 6.28 is a scenario where a catastrophic LUST release occurred 5 years in the past (and the UST was refurbished, remanufactured or replaced). The groundwater investigation, though, did not occur until recently. This depiction indicates that the groundwater table elevation rose several tens of feet over the past 5 years (e.g. areas where production wells cease to operate). If the investigator did not gather information on historical groundwater levels, monitor wells screened at the water table will give the false impression that groundwater was not affected by the release.

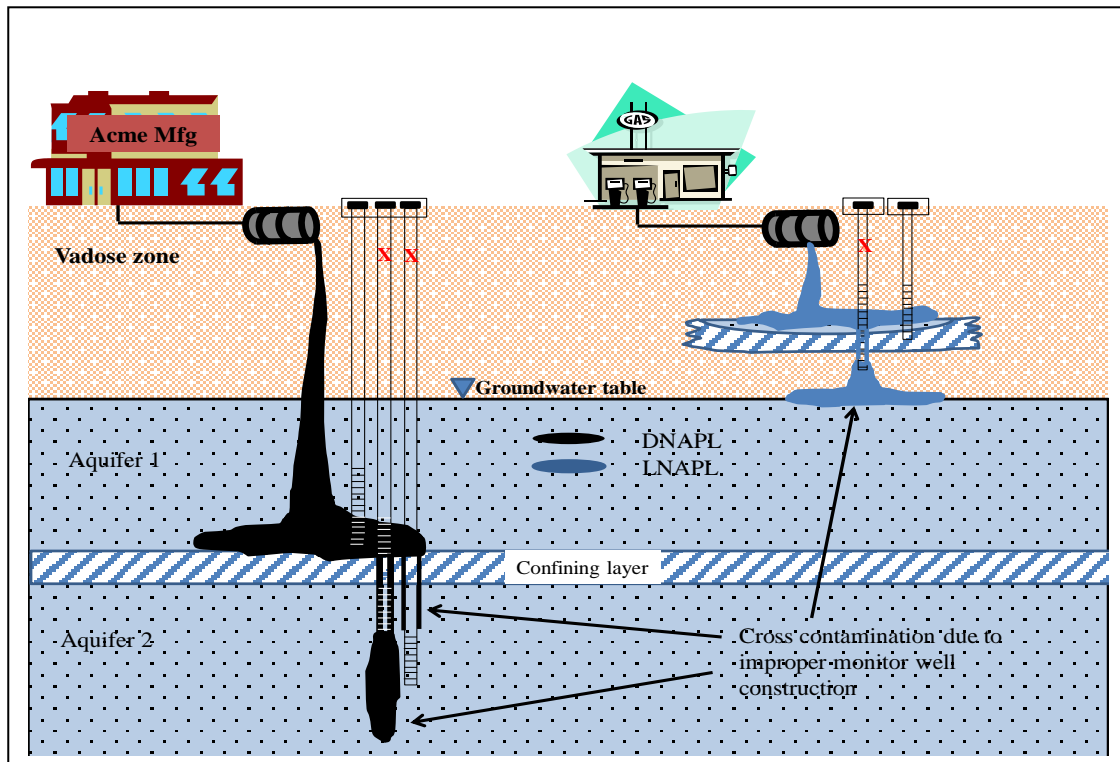

Figure 6.27 Improper Monitor Well Construction. Simple model of improper monitor well installation. The improper well installations are causing cross contamination. The red “x” marks improperly installed monitor wells.

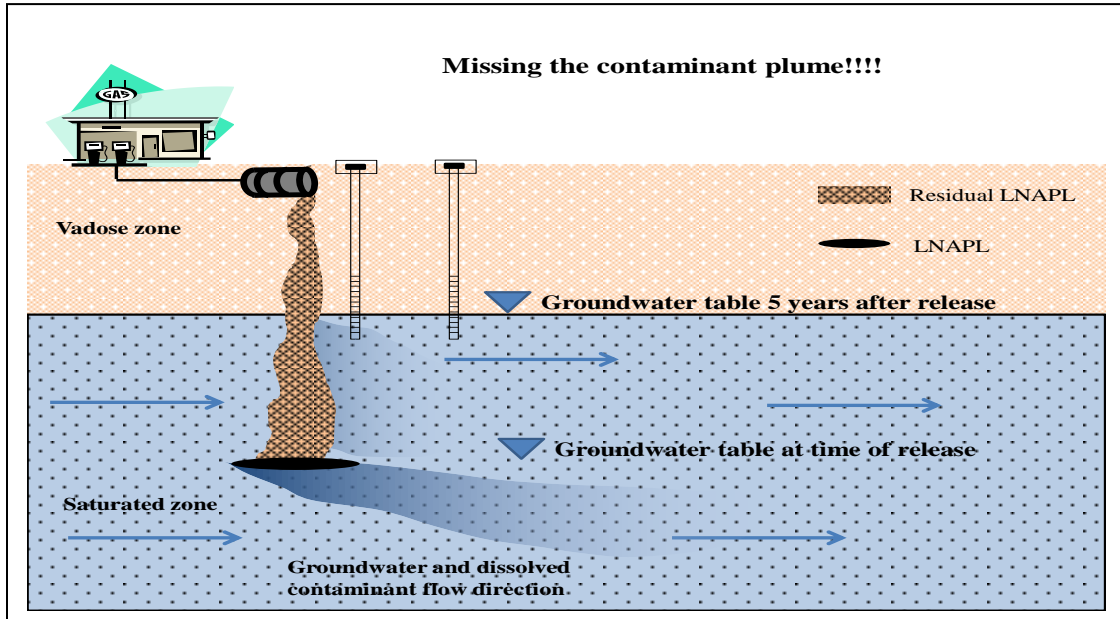

Figure 6.28 Incomplete Historical Data Collection. The investigator in this scenario did not collect historical groundwater elevation data or investigate deep enough into the saturated zone. This caused false conclusions by the investigator regarding impacts to groundwater.

Conversely, Figure 6.29 is a scenario where a monitor well that is screened too deeply is used to assess site conditions. The investigator in this situation did not do his homework on monitor well construction or groundwater table elevations. The investigator incorrectly identified the “out of operation” gas station as the source of groundwater contamination.

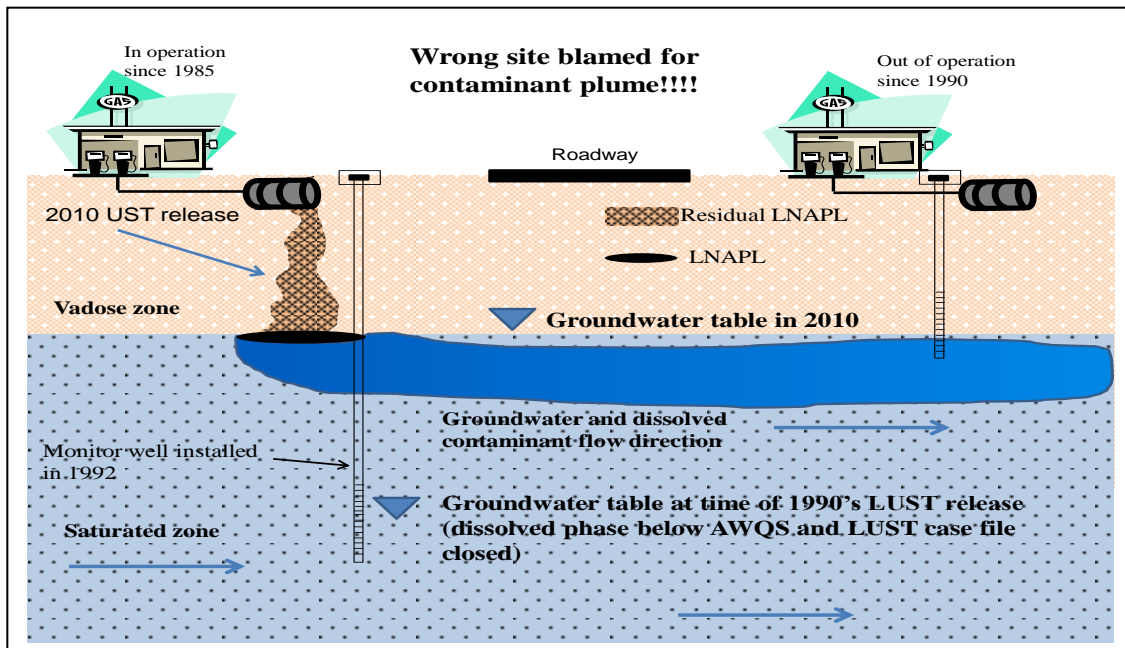

Figure 6.29 Inaccurate Conclusion on Source Area. The investigator in this scenario uses the 1992 monitor well to draw incorrect conclusion as to the source of the groundwater contamination.

DNAPL Accumulations:

Low permeability lithologic layers within the aquifer can cause DNAPL to accumulate (Figure 6.30). Identifying the locations of DNAPL accumulations can be challenging. A good knowledge of stratigraphy is critical to identifying potential locations of DNAPL accumulations. However, drilling in the source area, if necessary, should proceed with the utmost caution as contamination can be driven deeper during the investigation. Figure 6.30 details a strategy for identifying intervals of relatively higher dissolved contamination within the saturated zone. The relatively higher dissolved contamination intervals are indicative of the depths where DNAPL accumulations are located. Collecting samples using drive push techniques and analyzing the samples on site (**real-time data**) will assist in deciding whether nested wells are necessary and where to place screen intervals for nested wells (**recognition primed decision**). Once the locations of the DNAPL accumulations are identified, remedial efforts can focus on those source areas.

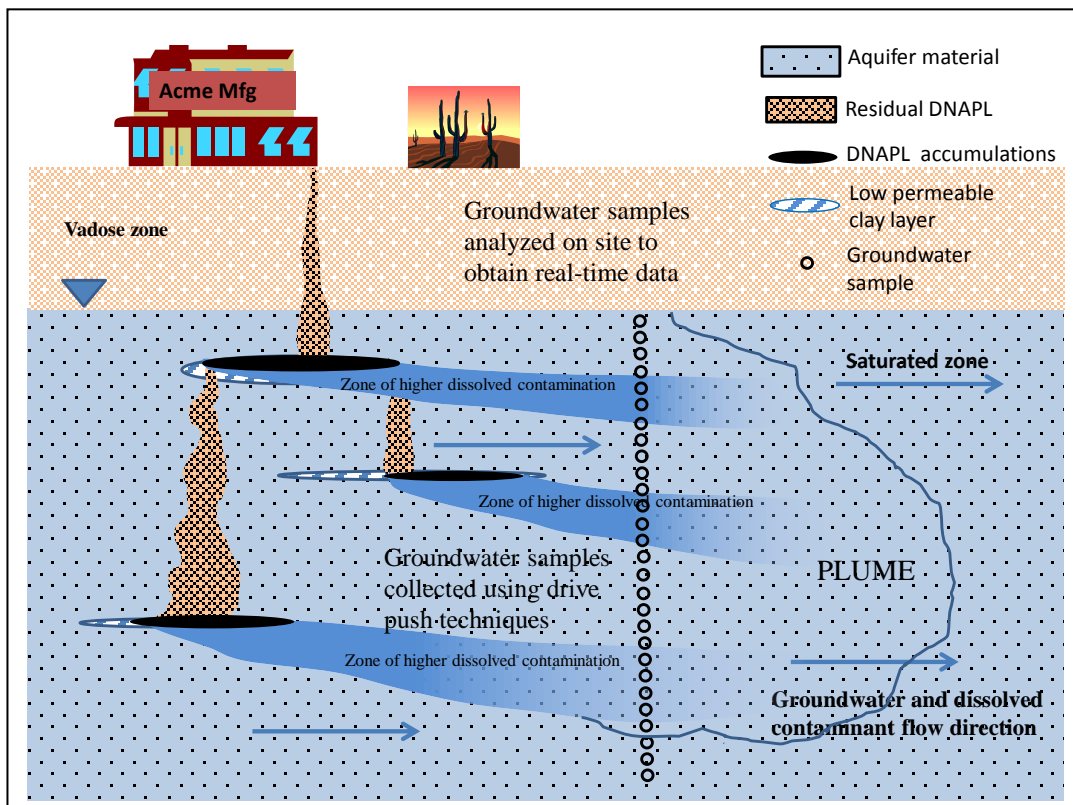

Figure 6.30 Locating zones of Higher Dissolved DNAPL Concentrations using real-time data techniques.

Vadose zone conditions:

Lithology in the vadose zone is an important consideration during decisions regarding placement of monitor wells. If coarse material is known to occur throughout the thickness of the vadose zone, groundwater source area monitor wells can be placed near and downgradient of the release location for the purpose of identifying a groundwater impact. If low permeable units are expected to be encountered, a good knowledge of the vadose

zone lithology will be necessary for installing a useful monitoring well network. Please see “Section 6.1.2.2 – NAPL Migration in unsaturated zone” for information on NAPL migration in the vadose zone.

Figure 6.31 depicts a release where the contaminant release encounters a low permeable clay layer and then migrates along that clay layer. The migration route will be dictated by the orientation of the clay layer. The clay layer can extend a great distance beyond a property boundary before it gives way to coarser lithology (the ground surface slope should not be utilized to make judgment on the orientation of the subsurface clay layer). This complicated condition can give the appearance that offsite groundwater contamination originated from a source other than the property subject to investigation.

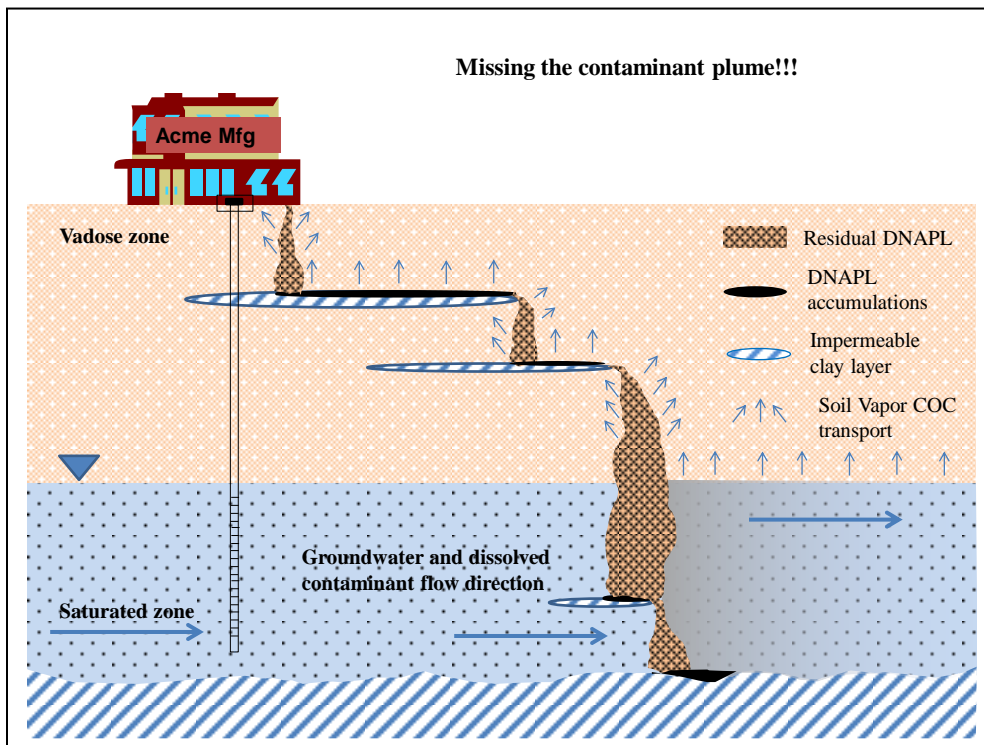

Figure 6.31 Incomplete Characterization of the Subsurface. The clay layer should be investigated to determine orientation and extent. Once orientation and extent of the clay layer are determined, a proper monitor well network can be installed.

6.3.4 Monitor Well Placement

A plume is a dynamic, three-dimensional distribution of contaminants in groundwater that generally necessitates three-dimensional monitoring. Plume shape is influenced by many factors, including original source distribution, geology, hydrology, and biologic processes. The resulting spatial and temporal variability significantly impact choice of monitoring locations and frequencies and necessitate continual re-evaluation of the monitor well network (EPA, 2004).

6.3.4.1 Vertical Extent at the Source Area

The initial groundwater investigation should consist of the installation of a single (or nested) monitor well at each potential release point as appropriate. The well(s) should be constructed in accordance with the well construction requirements as described Section 6.3.2.

Aquifer material sampling:

During source area monitor well installation(s), aquifer material (solids and liquids) should be collected and physically and chemically analyzed to investigate the vertical extent of contamination below the water table. Historical groundwater table elevations should also be considered during initial source area monitor well installation(s)

It is necessary to identify target zones (i.e. submerged free phase, smear zone or dissolved phase) beneath the groundwater table so that targeted active remediation, if necessary, can occur. Various tools exist for determining depth specific contamination such as SimulProbe® and Hydropunch™. Vertical characterization will allow you to optimize well and screen locations. These target zones need to be identified so that:

1. The full vertical extent of contamination can be determined;
2. Appropriate decisions can be made on screened interval placement for source area(s) monitor wells;
3. Appropriate decisions can be made on screened interval placement for monitoring wells upgradient, laterally, and downgradient of the contaminant source area(s);
4. Appropriate decisions can be made on groundwater sampling methods and depths so as to capture current contaminant information at and below the water table;
5. Periodic and compliance groundwater sampling can be conducted in a manner that gives information on the contaminant levels in the target zones;
6. All necessary information can be collected to assess all exposure pathways relating to groundwater contamination; and
7. The CSM is as complete as possible.

6.3.4.2 Lateral Extent of the Groundwater Contaminant Plume

If the groundwater flow direction is known, a monitor well should be placed directly downgradient of the source area monitor well. At a minimum, at least two additional monitor wells will be required to fully determine the lateral extent of groundwater contamination; one further downgradient and one crossgradient from the release(s). These additional groundwater monitoring wells should be installed such that an extrapolation of the three-dimensional subsurface extent of the contaminant plume may be determined for levels exceeding the regulatory cleanup standards.

If the groundwater flow direction is not known, monitor wells should be placed in a triangular pattern. One monitor well should be placed at the source area. Two other monitor wells should be placed so that their locations, along with the source area monitor well form as best an equilateral triangle as site conditions allow. This will allow calculation of a groundwater flow direction. Please see the section on “Additional monitor wells” located directly below to ascertain if additional monitor wells may be required.

The position of the downgradient well is dependent on site-specific conditions which affect the extent of plume migration. The crossgradient well should be positioned to help determine an [accurate direction of groundwater flow](#), and to establish the relative dispersion, spreading, and crossgradient extent of the contaminant plume. In addition to placing a monitor well in the downgradient direction, real-time measurement technologies (as part of the Triad Approach) can be utilized to assist in placing the lateral extent monitor wells as near as possible to the periphery of the leading edge of the plume.

Additional monitor wells:

The installation of additional monitor wells may be required under any of the following circumstances:

1. The downgradient and crossgradient wells: a) do not adequately characterize the distribution of the contaminant plume between the source area well and the downgradient extent of the contaminant plume; and b) do not provide enough information to develop a CSM that addresses all exposure pathways;
2. The downgradient well does not define the downgradient extent of the contaminant plume;
3. The analytical data from the crossgradient well does not provide adequate information to develop an accurate conceptual site model;
4. The groundwater flow direction is not consistent or cannot be adequately determined based on the three monitor wells;
5. The initial estimate of the groundwater flow direction was not accurate, and as a result, the downgradient extent of the plume remains undefined;
6. The extent of groundwater contamination needs to be determined between the contaminant plume and receptors, such as supply wells or springs;
7. The water table has risen above the top of or fallen below the well screen, such that groundwater samples representative of the aquifer contamination at that location of the plume cannot be obtained; and
8. Multiple upgradient and crossgradient contaminant sources have impacted groundwater and the effect of these impacts upon the subject site has not previously been investigated.

The Department may determine, on a site-specific basis, whether or not the extent of contamination is defined despite levels of contamination exceeding regulatory cleanup standards in the monitor well furthest downgradient of most sidegradient. Among the criteria which the Department may consider in these site-specific evaluations are:

1. The level of the regulatory threshold exceedance;
2. The nature, degree and type of pre-existing contamination;
3. Current and potential future uses of groundwater;
4. Planned or proposed remedial actions for pre-existing contamination;
5. Other site-specific conditions which may affect types of groundwater uses, remedial options, hydrologic conditions, changes to groundwater quality (e.g., distance to next accessible well location; vertical distance between the screened interval of receptor wells and the contaminant plume; salinity of the groundwater);
6. Other information provided by property owner or responsible party; and
7. The existing data and CSM, taken as a whole, allow the Department to reasonably extrapolate the extent of contamination above the regulatory threshold.

When a COC does not have a numeric AWQS, the extent of contamination is defined using the regulatory criteria discussed in Section 2.4.1 in a site-specific manner, using the same criteria as above.

6.3.4.3 Example of Monitor Well Placement

The density of sampling points in a monitoring network will depend on the geology and hydrology, the spatial scales at which contaminant distribution varies horizontally, vertically and temporally, and the desired level of confidence in the evaluation. Plumes often vary significantly in concentration in transverse and vertical cross sections making evaluation of contaminant distribution and remedy performance difficult. In these cases, a dense network of monitoring points will often be needed to support many of the performance monitoring evaluations.

Monitoring Locations:

The use of a transect-based approach (Figure 6.32) to monitoring may greatly reduce the uncertainty in performance monitoring evaluations at many sites by improving the definition of contaminant distribution and its variability. The transect approach helps to locate groundwater flow lines and contaminant migration paths. Transects also provide a better definition of contaminant distribution under conditions of changing hydraulic gradients.

Generally, each distinct zone of contaminant migration and geochemical regime is monitored to assess its impact on remediation. For instance, if part of a plume of PCE is anaerobic with high levels of electron donors available and another part of the plume is aerobic with few electron donors available, degradation of the PCE may be very active in the anaerobic zone but nonexistent in the aerobic zone. For each zone with distinctly different conditions or controls on contaminant migration and fate, the following locations would be monitored: areas hydraulically upgradient and sidegradient to the plume, source area, main body of the plume, and distal portions and boundaries of the plume.

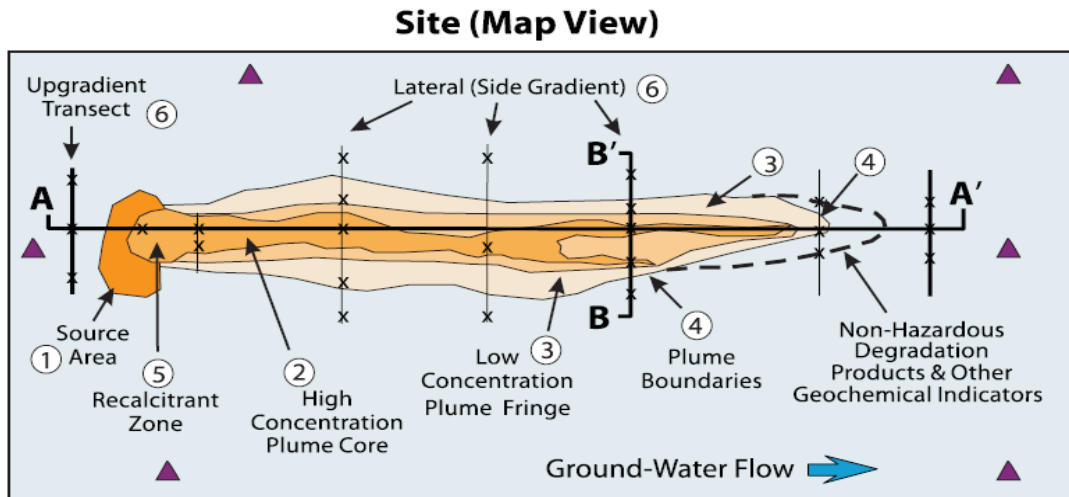

Target Monitoring Zones

- | | |
|--|-----------------------------------|
| 1. Source area | |
| 2. Contaminated zones of highest concentrations and mobility | |
| 3. Plume fringes | x Monitoring well cluster |
| 4. Plume boundaries | ▲ Piezometer |
| 5. Recalcitrant zone determined from historical trends | -x-x-x- Transect of well clusters |
| 6. Upgradient and sidegradient locations | |

Figure 6.32 Monitor Well Network Design Example. Example of a network design for performance monitoring, including target zones for monitoring effectiveness with respect to specific remedial objectives. In this example, monitoring network design is based on transects of wells oriented perpendicular to the groundwater flow direction. Sampling locations for target monitoring zones were chosen based on site characterization. Piezometers provide additional data for evaluation of changes in potential groundwater flow direction ([EPA, 2004](#)).

Typical Target Zones:

Typical target zones for monitoring a contaminant plume include:

- *Source areas - within and immediately downgradient of remediated source areas*

The monitoring objectives are to determine and demonstrate whether any further contaminant releases to groundwater occur and to estimate contaminant reduction over time. In situations where the source is contained, increased contamination or new contaminants could be indicative of such conditions as cap failure, buried drums that rupture, a rise in the water table transferring additional contaminants from the vadose zone, or slurry wall failure. These new contaminant releases could be greater than the

capacity of the subsurface to attenuate concentrations without significant plume expansion or could include contaminants not effectively remediated by natural attenuation.

- *Transmissive zones with highest contaminant concentrations or hydraulic conductivity*

A change in conditions in these zones, such as an increase in contaminant mass from source areas or increased groundwater velocity, may lead to a relatively rapid impact to a downgradient receptor.

- *Distal or fringe portions of the plume*

These are areas where reduction of contaminant concentrations to levels required by remedial action objectives may be attained most rapidly or where plume expansion may be observed.

- *Plume boundaries and other compliance boundaries*

Multilevel monitoring points typically would be placed at the sidegradient, downgradient, and vertical plume boundaries (Figure 6.33), and between these boundaries and possible receptors. Multilevel monitoring generally should also be performed at any other compliance boundaries specified in remedy decision documents. Results from these monitoring locations may directly demonstrate unacceptable plume expansion and changes in groundwater flow directions.

- *Zones in which contaminant reduction rates appear to be lower than required to meet remediation goals (i.e., recalcitrant zone)*

These are the areas where attaining cleanup standards within accepted time frames may be impeded due to site conditions (e.g., presence of previously undetected source materials or low flux of electron acceptors). Such areas, if present, will be delineated through evaluation of data obtained throughout the performance monitoring period. These areas may require additional characterization to determine if additional remedial actions are necessary to reduce contaminant concentrations to desired levels (EPA 2004).

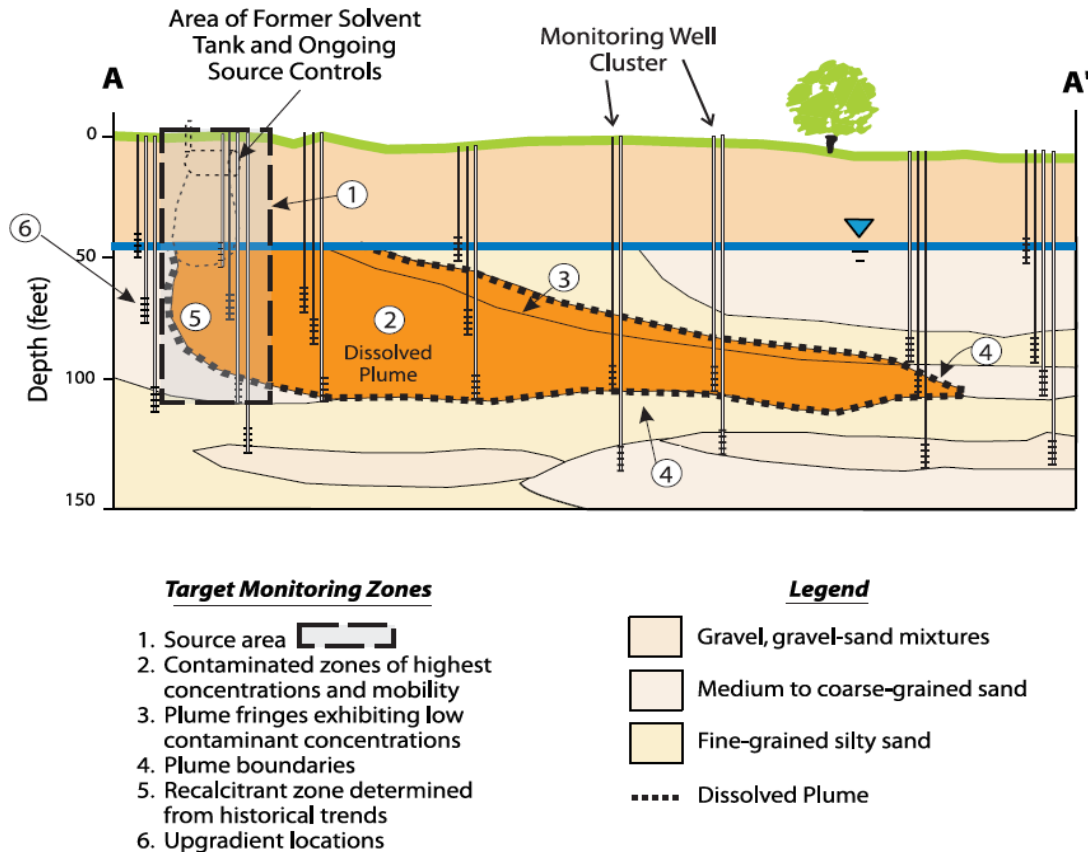

Figure 6.33 Cross Section of Monitor Well Network Design. Cross section A-A' through monitoring network in general direction of groundwater flow. Placement of monitoring points within target zones is based on geologic controls and contaminant distribution characterized prior to remedy selection and is periodically modified, as warranted, based on evaluation of performance monitoring data. In this scenario, detailed site characterization data would be used to define the limits of the source area, the distribution of any NAPL and aqueous-phase contaminants, and the effectiveness of source removal and control actions. Source control activities and monitoring associated with the release from the former solvent tank are not pictured (Modified from EPA, 2004).

- *Areas representative of contaminated and uncontaminated geochemical settings*

Sampling locations for monitoring the geochemical setting include monitoring points that are hydraulically upgradient and sidegradient with respect to the plume (Figure 6.34). Because assumptions concerning the geochemical setting and naturally occurring changes in geochemical parameters affect interpretation of data from the plume, such assumptions should be tested and evaluated like other parts of the conceptual site model. Therefore, multiple monitoring points generally should be used to determine the variability of geochemical conditions outside the plume. Data concerning the movement of electron acceptors, donors, and any contaminants into the plume aid in understanding and

interpreting data from the plume. These geochemical data are used to determine whether the observed differences in geochemical parameter concentrations within the plume are due to contaminant transformation processes rather than natural variations in the background geochemical conditions. The locations sidegradient to the plume help to evaluate changes in plume geochemistry with time as groundwater migrates through uncontaminated aquifer materials. Changes in geochemistry within the plume may not be directly related to attenuation of the contaminants, so geochemical changes outside the plume generally should be assessed and compared to geochemical changes taking place within the plume. If upgradient and lateral monitoring points show geochemical changes similar to changes in the plume, such changes may not be attributed solely to contaminant-related processes (i.e., degradation), and, therefore, may not serve as supporting evidence for degradation processes.

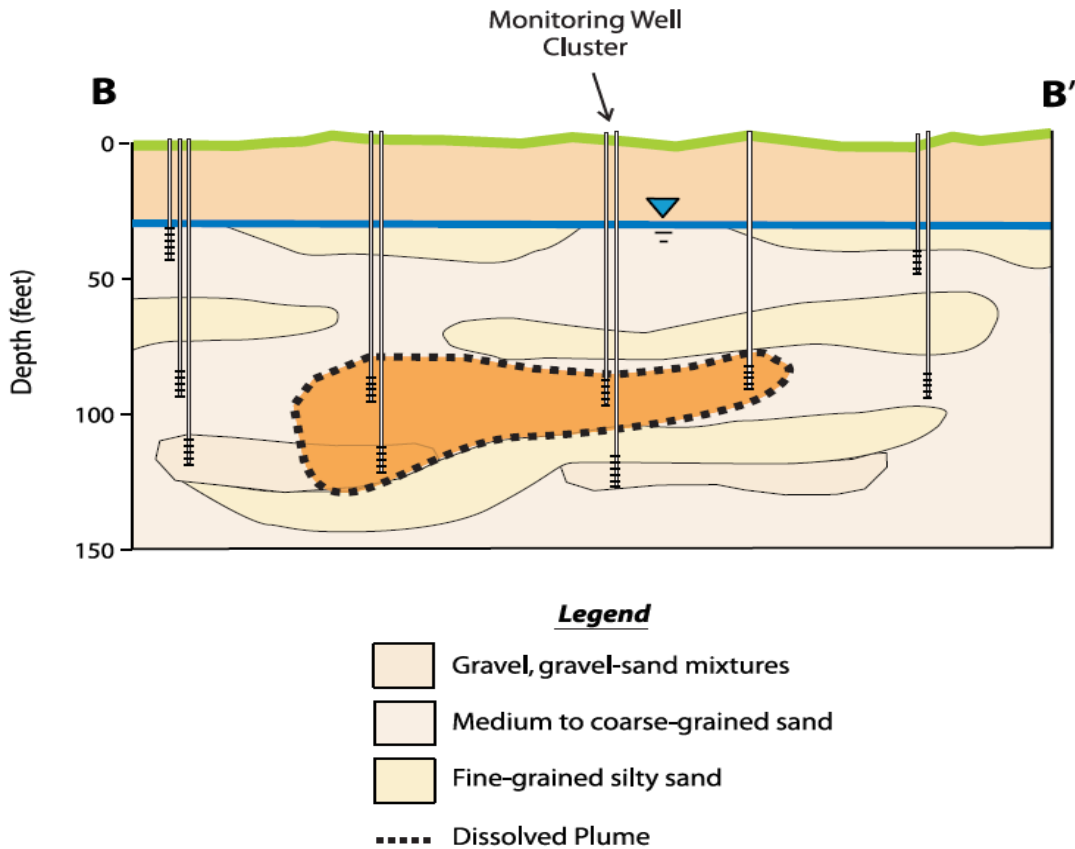

Figure 6.34 Cross Section of Monitor Well Network Design. Cross section B-B' through monitoring network perpendicular to groundwater flow. Monitoring points are placed to define the plume horizontally and vertically, as well as monitor contaminant concentration zones and geochemical zones (Modified from [EPA, 2004](#)).

- *Areas supporting the monitoring of site hydrology*

At some sites, monitoring of groundwater elevations at locations additional to those used for the monitoring of chemical parameters may be needed to determine hydraulic gradients. At such sites, appropriate locations for placing piezometers will often include positions that are upgradient and sidegradient to the contaminant plume, as well as in zones above and below the plume. Piezometers are usually spaced across the site so that groundwater elevation measurement errors are relatively small compared to the difference in groundwater elevations between piezometers (EPA, 2004).

6.3.5 Groundwater Monitoring

6.3.5.1 Groundwater Elevation Measurements

The purpose of groundwater monitoring is to collect data for updating the CSM and planning remedial activities. During the site investigation process, the depth to groundwater should typically be measured quarterly for one year to ensure that the complete seasonal variation of the groundwater elevation, flow direction and gradient are documented. Frequency of measurement is based on the sufficiency of existing local water table information, applicable to the site's hydrologic setting. However, this information may be absent for some areas. More frequent measurements may be necessary in those circumstances.

Several factors contribute to changes in the groundwater elevation and should be considered when adopting an alternative measurement schedule. Examples of such factors include duration, frequency and rates of precipitation; pumping rates, location and screen intervals of production wells; presence and type of surface water; transmissivity of geological formation. Alternative measurement schedules should be based on these factors but typically are no more frequent than monthly over a one year period. Regardless of the measurement frequency and duration chosen, the measurement schedule should provide data useful in:

1. Determining the full extent of contamination;
2. Validating a CSM reliant upon extensive modeling or limited data; or
3. Developing a remedial action plan or corrective action plan.

Once the seasonal variations are documented, the period of monitoring groundwater elevations should be reduced according to site-specific conditions. It is also very important to ensure that groundwater samples collected for chemical analysis are taken from the target zones identified during the investigation process.

Depth to groundwater measurements are usually accomplished by doing the following:

1. Reference all water level measurements to the survey mark at the top of the casing (normal procedure is to mark the north side of well casing). The

- reference point should be surveyed and marked by an Arizona Registered surveyor;
2. Use either a weighted steel tape with chalk or an electronic water level indicator to measure the depth to water. Select the measuring device carefully for wells deeper than 200 feet to ensure that the tape does not stretch. The measurement should be taken with an accuracy of ± 0.01 feet.
Please note - Duplicate measurements are typically done to reduce the chance for error. Results from the previous round of measurements are typically compared with the current round while still in the field for the purpose of noting anomalies;
 3. Wells with submerged screens should have the well cap removed at least 15 minutes prior to gauging to eliminate the effects of rising or falling water levels prior to the gauging event. Rising or falling water levels prior to removing the well cap will create either pressure or a vacuum on the well that will impact the water level in the well unless sufficient time is allowed for the well to equilibrate.
 4. In addition, wells with submerged screens should be gauged continuously for several minutes to document that the water level has equilibrated.
 5. If groundwater sampling is to be completed on the same day, measure the depth to water prior to sampling.
 6. Calculate the water table/potentiometric surface elevation by subtracting the depth to water from the reference point elevation. Correct elevations for barometric and free phase density influences.

Total well depth measurements are accomplished by:

1. Lowering the probe to the bottom of the well and referencing the depth to the surveyor's mark.
2. Note whether silt is encountered at the bottom of the well.
3. Repeat the total well depth measurement at least once to confirm the measurement.
4. If groundwater sampling is to be completed on the same day, measure the total well depth after sampling has been completed to prevent suspension of silt into the water column.

Free product measurements are accomplished by:

1. Measure wells with free phase product last.
2. Use an oil-water interface probe (Figure 6.35) manufactured for use in free-phase product.
3. Measure the depth to the top and bottom of the free phase in reference to the surveyor's mark at the top of the casing. In LNAPL plumes, this would be on top of the water



Figure 6.35 Oil-Water Interface Probe (Hawaii, 2009)

- column.
4. Correct the water table elevation for the thickness of the free product floating on top of the water column.
Please note - [The corrections](#) have to be based on the actual density of the LNAPL present at the site.

6.3.5.2 Groundwater Purging Prior to Sampling

Purging:

The purpose of well purging before groundwater sampling is to ensure that the samples will be representative of the groundwater and contaminant levels in the vicinity of the well. If a well is left untended for prolonged periods, the water contained within the well and possibly within the filter pack may not be representative of the surrounding aquifer formation water. For example, water extending above or below the well screen may be stagnant and may have undergone physiochemical changes, such as volatile loss into headspace, or change in oxidation-reduction potential through gas exchange with headspace, etc. Excessive purging may result in biased groundwater samples, since it may dilute or increase the contaminant concentrations at the sampling point (EPA, 2002).

Choose a purging device that will not alter the geochemical and physical parameters of the groundwater and dissolved contaminants or increase turbidity. Keep the contaminant characteristics in mind when selecting a purge device, for example, do not choose a purge device that will cause volatilization if the contaminant of concern is a volatile compound. Also, ensure that the purging device material is chemically inert and that it does not adsorb contaminants (EPA, 2002). Preferred device materials are PVC, stainless steel and Teflon®.

If practicable, use low-flow submersible or positive displacement pumps with variable-speed control. Other purging devices include suction lift pumps or peristaltic pumps, and bailers, though due to the greater potential to alter geochemical and physical parameters of groundwater and other limitations, their use is generally limited to monitoring wells with specific characteristics and/or contaminants.

There are two potential intake positions for well purging: above the well screen or within the well screen. If purging above the well screen (i.e. if the screen interval is below the water table), start purging at the water table and gradually lower the pump so that it sits just above the top of the well screen at the end of purging. This will ensure that the stagnant water above the screen has been purged. It also ensures that during sampling, the groundwater has the shortest riser length to pass (EPA, 2002).

If the intake is placed within the well screen interval, place the intake into the zone of highest contamination. This method is especially effective if a low-flow purging and sampling technique is used (EPA, 2002).

All groundwater extracted from wells during purging should be properly containerized, staged, sampled, and disposed. Do not allow water to flow onto the ground. Place all

downhole equipment onto a clean plastic sheet to ensure that the ground around the well is not cross contaminated by groundwater, and to ensure that downhole equipment does not transfer surface materials into the well.

Low-Flow Approach:

Researchers have evaluated the relative merits of traditional purging methods; improved methods of purging have evolved out of efforts to improve sample accuracy and precision and to collect more representative samples (Nielsen, 2006). One improved purge method includes low-flow purging (also commonly referred to as micro-purging, low-stress purging, low-impact purging, or minimal drawdown purging). Low-flow purging involves the same approach and equipment as low-flow sampling (described below).

The purpose of the low-flow purging is to sample a specific depth within a well screen interval. Low-flow purging, whether using portable or dedicated systems, should be done using pump intake located in the middle or slightly above the middle of the screen interval. Placement of the pump at the top of the water column for sampling is only recommended in unconfined aquifers, screened across the water table, where this is the desired sampling point.

Carefully place the pump into the well at the selected depth within the well screen to avoid turbulence within the well. The approach is based on the assumption that under minimal drawdown the pump will not draw down stagnant water from the well portion above the pump. Therefore, the drawdown in the well must be kept at a minimum and should not exceed 0.33 feet or 0.1 meter (Puls and Barcelona, 1996). This involves regular water level measurements, i.e. gauging, throughout purging and subsequent sampling. Gauging intervals can be as short as 30 seconds or as long as 5 minutes, depending on the hydraulic conductivity of the aquifer. Typically, flow rates on the order of 0.1 to 0.5 liters per minute are used; however, this is dependent on site-specific hydrogeology. The use of a variable-speed, low-flow sampling pump greatly assists in changing the flow rates and thus minimizing drawdown. Bailers, suction-lift pumps, and high-flow rate pumps cannot be used for low-flow purging and sampling. The low-flow method is applicable for all types of aqueous phase contaminants and naturally occurring chemicals in aquifers with low to high permeability. Low-flow purging and sampling is generally not appropriate for very low-yield monitoring wells.

Generally, the time or purge volume required for parameter stabilization is independent of well depth or well volumes. Dependent variables are well diameter, sampling device, hydrogeochemistry, pump flow rate, and whether the devices are used in a portable or dedicated manner.

Throughout purging, regularly measure and record water quality parameters. Preferably, water quality parameters should be measured with a device that prevents contact with air, such as a flow through cell. The following criteria are typically achieved during well purging:

- Well water pH stabilizes to within ± 0.1 pH units for three successive readings.
- Well water temperature stabilizes to within ± 1 degree Celsius.
- Well water conductivity stabilizes to within ± 3 percent.
- Well water oxidation reduction potential stabilizes to within ± 10 millivolts.
- Well water dissolved oxygen concentration stabilizes to within ± 0.3 milligrams per liter.
- Well water is clear to the unaided eye in areas where the local groundwater is known to be clear and the turbidity readings are below 10 NTUs.
- Turbidity stabilizes to within ± 10 percent at readings higher than 10 NTU. In areas of known turbid groundwater, the final well water may be turbid to the eye.

Well Volume Approach:

A summary of limitations of the fixed well-volume purging approach is provided in “The Essential Handbook of Ground-Water Sampling” (Nielsen and Nielsen, 2007). The well volume purging approach is described below as a potential option for specific circumstances. Rationale for use of this purging approach should be clearly documented.

The purpose of the well volume approach is to remove all stagnant water or non-representative water within the well, the filter pack, and the adjoining formation. For wells where the water level is above the well screen (i.e., a fully saturated screen interval), start pumping near the water table and lower the pump slowly throughout the purging process. The final position of the pump should be just above the screen interval.

For wells where the water level is within the well screen, set the pump to a level such that the drawdown does not allow air to enter the pump. Set the pump high enough that sediment from the bottom of the well is not introduced into the pump (EPA, 2002). Keep the pump rate low enough to avoid turbulent flow within the well; for a 2-inch well that is typically less than one gallon per minute or 3.8 liters per minute (EPA, 2002).

Alternatively, use a bailer to remove groundwater from the well. Start bailing near the water table and keep lowering the bailer as purging continues. Do not lower the bailer to a depth where bailing will disturb sediment at the bottom of the well. Avoid introducing turbulence near the bottom of the well that could lead to suspension of sediment into the water column. Monitor water quality parameters after removal of each well volume (the well volume includes the saturated filter pack volume).

Continue purging until a minimum of three well volumes are removed and the water quality parameters have stabilized. The stabilization criteria typically monitored during purging are the same as those listed above under Low-Flow approach.

Purging Low Permeability Formations:

The procedures described in this section are for use in very low permeability formations, where wells are slow to recover. In wells that are screened below the water table, purge water in storage in the well casing from above the screen, and avoid dewatering and introducing air into the well screen interval. Do not lower the pump into the well screen interval, but pump from the top of the water column, following the water level down to the top of the screen. This procedure requires pumping at low rates to prevent excessive draw down, so bailers or inertial-lift pumps should not be utilized (EPA, 2002).

In wells that are screened across the water table, it has been common practice to purge the well dry and let it recover for a minimum of 2 hours and until sufficient water volume is present to take a water quality sample or the well has recovered to 90%.

Although it is recognized that purging to dryness may lead to significant problems such as loss of volatiles, increased turbidity, and changes in dissolved gases, alternatives for these low yield wells may be limited, especially in cases with less than 4 feet of water in the well and a depth to water of more than 20 feet (EPA, 2002).

6.3.5.3 Groundwater Sample Collection Methods

The purpose of groundwater sampling is to collect samples representative for the aquifer at the well location. Consider the characteristics of the contaminant(s) such as volatility, solubility, density (denser or lighter than groundwater) and their resultant fate in the subsurface (adhesion to soil particles, biodegradation etc.) during selection of the sampling approach.

The following sections describe different methods of groundwater sampling, the different types of equipment for each method, and details on the appropriate applications for each method.

Low-Flow Sampling (usually preceded by low-flow purging):

The purpose of low-flow sampling is to collect representative groundwater samples for a specific depth within a well screen interval. The method is based on the assumption that given sufficiently low removal rates, a sampling pump will not draw stagnant water from the water column above and below the position of the pump. Therefore the rate of removal must be kept to a minimum in order to minimize drawdown and should not exceed 0.33 feet or 0.1 meter (Puls and Barcelona, 1996). Typically, flow rates on the order of 0.1 to 0.5 liters per minute are used; however, this is dependent on site-specific hydrogeology. The method is most applicable in aquifers with medium to high permeability.

When sampling:

1. Do not move the pump intake location between the end of purging and the beginning of sampling. Any adjustment of the pump depth or pump speed will require renewed purging.
2. Do not pause the pump between purging and sampling. Keep the pump

rate throughout sampling low enough that the groundwater flow exiting from the discharge tube is laminar and does not induce turbulence in sampling containers.

Submersible Pumps:

Submersible pumps move water up a well by applying positive pressure; however, instead of a pushing motion, submersible or centrifugal pumps typically use electric-motor driven impellers to drive the water to the surface. The impellor pressure is equal to the hydraulic head in the tubing extending from the pump to the top of the well.

Submersible pumps are portable and do not require compressed gases or air pumps. They generally have higher discharge capacities than positive displacement pumps and may therefore be more effective as a well volume purging method and for collecting of samples for non-volatile contaminants. They may also be used to collect samples for VOCs; the impellor motion, though, may be prone to cavitation, inducing bubble formation that may affect pressure sensitive components such as dissolved gases or VOCs.

Peristaltic Pump Sampling:

A peristaltic pump (Figure 6.36) operates by a circular motion creating a vacuum in an intake line drawing from the monitoring well. The vacuum draws groundwater up to the pump, where the water is dispensed from the end of the tubing. Tubing used for peristaltic pump sampling should be disposed of after one use. A diagram of the working end of a peristaltic pump is illustrated here.

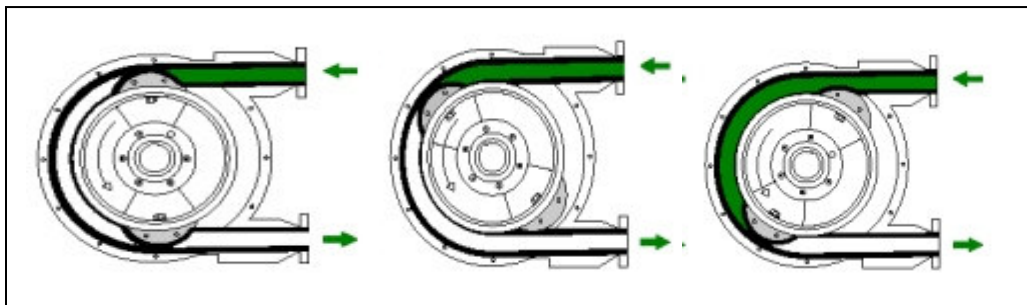

Figure 6.36 Peristaltic Pump Head (Hawaii, 2009)

Peristaltic pumps have advantages in that they have few moving parts, do not need compressed gas or pumps, are generally very portable, and are easily set up and used; further, the tubing and pump heads can easily be replaced (USGS, 2002). Peristaltic pumps can produce a maximum lift of up to 20 to 25 feet and provide a pump rate of 1 to 2 liters per minute.

Peristaltic pumps do, however, have limitations in use and ability to collect representative samples for some contaminants. The vacuum induced in the downhole tubing can also result in loss of dissolved gases or volatile components. In addition, the tubing could diffuse atmospheric gases sufficiently to affect some target gases.

Peristaltic pumps therefore are less likely to result in representative samples for the following analyses:

- Volatile organic compounds
- Semi-volatile organic compounds
- Dissolved oxygen
- Oxidation reduction potential
- Carbon dioxide
- pH
- Iron and its associated forms.

A peristaltic pump may be proposed for use primarily if the following conditions exist:

- Depth to water is less than 15 to 20 feet;
- There is limited recovery of water in a monitoring well; and
- Contaminants of concern do not include any on the previous list (EPA, 2002)

Bailer Sampling

A bailer is a well purging and/or sampling device that may be appropriate for use under limited circumstances. The simplest bailer consists of a rigid tube equipped with a check valve at the bottom and a means to attach a line to the top. The check valve allows water in to the interior chamber of the bailer as it is lowered into the saturated zone. When the bailer is raised the check valve is forced shut and a water sample can be retrieved from the well.

Bailers (Figure 6.37) may be dedicated to a single well to avoid cross contamination. In instances where well volume purging is also being done by bailer, the sampling and purging should be done with separate bailers intended and designed for the respective tasks.

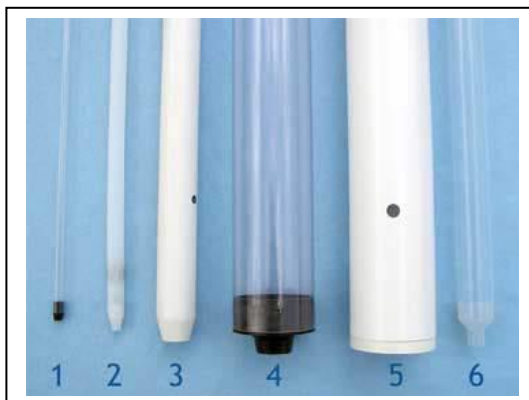

Figure 6.37 Bailer Types. Bailers used for purging and sampling. 1 is a Micro-bailer; 2 is a mini bailer; 3 – 5 are PVC bailers; and 6 is a Teflon bailer. (Hawaii, 2009)

Bailers are available in a variety of sizes and construction materials, e.g., PVC, Teflon®, and stainless steel.

Passive Diffusion Bags (PDBs):

Passive diffusion bag (PDB) sampling is a cost-effective alternative to standard (or low-flow) purge and sample techniques for collecting concentrations of a variety of VOCs in groundwater at monitoring wells. Using PDB samplers can result in significant cost savings at sites where VOCs are the constituents of concern and particularly where long-

term monitoring of groundwater is required. PDB sampling can also provide inexpensive and precise vertical contaminant concentration profiles that can be used to optimize remedial systems.

For more information on the use of PDB, the reader is referred to the ITRC website for links to [frequently asked questions](#) and [several guidance documents](#) regarding PDBs.

6.3.5.4 Monitoring Parameters

Monitoring Parameters:

In addition to hydrogeologic parameters, COCs and geochemical parameters should be monitored on a regular schedule. COCs may be identified from groundwater and soil monitoring data, contaminant source histories and evaluation of contaminants that [undergo transformation](#) (e.g. dichloroethene and vinyl chloride would be measured at sites contaminated with chlorinated solvents). At some sites, it may be necessary to identify and include chemicals that have only been tentatively identified in previous sampling (e.g., [Tentatively Identified Compounds](#) (TICs) – see Section 5.2.7 of this guidance manual).

At a well-characterized site, the DQO process or Triad Approach (rational choice strategy) can be used to choose parameters and monitoring frequencies for each monitoring location based on the value of the data to monitoring the contaminant plume, as an alternative to the measurement of all parameters at all locations. For example, if several years of monitoring indicate that the geochemistry in the central portion of a BTEX plume is stable, it may not be necessary or useful to continue to analyze samples from these locations for all of the geochemical parameters at each sampling event ([EPA, 2004](#)).

Monitoring Frequency:

Monitoring frequency affects the ability of the monitoring program to:

- Provide timely warning of impact to receptors,
- Detect contaminant releases to groundwater that warn of possible plume expansion,
- Detect changes in plume size/concentration,
- Determine temporal variability of data,
- Detect changes in geochemistry that warn of changes in attenuation, and
- Yield data necessary to reliably evaluate progress toward contaminant reduction objectives.

In most cases, quarterly monitoring for COCs and geochemical parameters will be an appropriate frequency to establish baseline conditions over a period of time sufficient to observe seasonal trends. In situations where hydrologic, geochemical and contaminant trends are stable and the conceptual site model is verified by measured site data, reductions in sampling frequency may be warranted. In situations where variability is high, increases in monitoring frequency and additional investigations to determine the source of the variability may be warranted. More frequent monitoring may be appropriate under circumstances where groundwater flow is rapid and/or contaminant travel time to receptors is short (EPA, 2004).

6.3.6 RCRA Subtitle C and D Sites – Background and Detection Monitoring

At RCRA Subtitle C and D sites, enough groundwater quality data should be collected to ensure water quality differences are not due to natural variation alone. [40 CFR 264.97\(g\)\(1\)](#) establishes requirements for the number of groundwater sampling events needed to establish the groundwater concentration. RCRA also makes a distinction between detection monitoring, where releases have not been confirmed and detection and corrective action monitoring where releases have been verified. For detection monitoring, the presumption is the site is clean and enough data must be collected to demonstrate otherwise. For compliance and corrective action monitoring, the site is presumed dirty and enough data must be collected to demonstrate it is clean. The demonstration is based upon statistical considerations which are discussed in [RCRA guidance](#) titled *Statistical Analysis of Groundwater Monitoring Data at RCRA Facilities* and dated March 2009.

6.3.7 Surface Water Investigation

An investigation of surface water should be initiated whenever the following conditions exist:

1. There is evidence that surface water [Arizona Administrative Code (AAC) R18-11-101(41)] has been affected by the release(s);
2. There is evidence that contaminated soils may be in contact with surface water;
3. ADEQ requests an investigation, based on the potential effects of contaminated soil or groundwater on nearby surface water; and
4. There is evidence that the highest downgradient groundwater levels for some portion of the year are at or above the elevation of the downgradient receiving body of water.

The Department recommends consulting with the associated program prior to the initiation of investigation of surface water. Guidance on conducting investigations on impacts to surface water is beyond the scope of this document.

6.3.8 Other References Used

Hawaii Department of Health. 2009. Technical Guidance Manual for the Implementation of the Hawaii State Contingency Plan. Chapter 6 – Groundwater and Surface Water Sampling Guidance.

Hyperlink:

<http://www.hawaiidoh.org/tgm-pdfs/HTGM%20Section%2006.pdf>

Ohio EPA. 2007. Technical Guidance Manual for Ground Water Investigations. Chapter 14 – Ground Water Flow and Fate and Transport Modeling

Hyperlink:

<http://www.epa.state.oh.us/portals/28/documents/TGM-14.pdf>

Important Information You Should Know after Reading Section 7.0 – Additional Topic Integral to Proper Investigations:

1. [Chemical and soil matrix properties that affects chemical distribution in the subsurface.](#)
2. [The effect of equilibrium partitioning on groundwater cleanups.](#)
3. [The effects of NAPLs on mass distribution equations.](#)
4. [Aerobic and anaerobic terminal electron acceptors.](#)

Chemical and soil matrix properties affecting chemical distribution in subsurface

When an organic contaminant is released to the subsurface, it will eventually equilibrate itself between two phases in the saturated zone (soil and water) and among three phases in the unsaturated zone (soil, water, and pore air). The distribution of the chemical of the phases are dependent upon:

- Two primary chemical properties:
Organic Carbon Partition Coefficient (K_{oc}); and Henry's Law Constant.
- One primary soil matrix property:
Organic carbon content

• **Organic Carbon Partition Coefficient (K_{oc}).**

The inherent difference among organic chemicals in their affinity for the organic carbon phase of the soil. The more hydrophobic the chemical (dependent on the chemical's degree of non-polarity), the greater the affinity of the chemical for soil organic carbon than pore water. (That is, the chemical would rather reside in the carbon than the water). The greater the value of K_{oc} , the greater the chemical's sorption in soil.

• **Henry's Law Constant:**

Some molecules of a dissolved organic chemical will escape from the water surface into the air phase. Eventually, the rate of molecules escaping from the water phase will equal the rate of air phase molecules rebounding back into the water. In other words, the concentrations of the chemical in the air phase, C_a , and water phase, C_w , will become constant; the two concentrations represent an equilibrium state of the chemical between water and air. The ratio between these two equilibrium concentrations is termed the Dimensionless Henry's Law Constant, K_H .

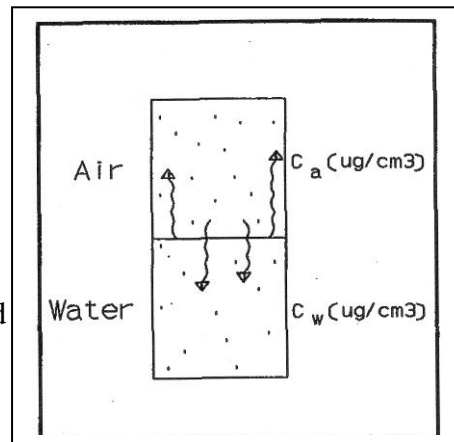

Groundwater cleanups and equilibrium partitioning

Because of equilibrium partitioning, an organic contaminant dissolved in groundwater travels slower than the groundwater, and a certain percentage of the contaminant is tied up in the soil phase rather than dissolved in groundwater. Therefore, groundwater cleanup plans that do not account for these phenomena will underestimate both contaminant mass and cleanup timeframes.

Effects of NAPLs on mass distribution equations

Because of equilibrium partitioning, an organic contaminant dissolved in groundwater travels slower than the groundwater, and a certain percentage of the contaminant is tied up in the soil phase rather than dissolved in groundwater. Therefore, groundwater cleanup plans that do not account for these phenomena will underestimate both contaminant mass and cleanup timeframes.

• **Organic Carbon Content**

Research has shown that in the sorption process the organic chemical actually moves into organic matter which adheres to the mineral surfaces of soil and aquifer particles. A portion of the organic matter consists of active organic carbon which is the actual sorbing medium. The greater the organic carbon content of the soil, the greater the amount of chemical sorbed by the soil. In fact, the sorption relationship is linear - doubling the amount of soil organic carbon will double the chemical concentration in the soil. The content of organic carbon in a soil is usually represented as the weight fraction, f_{oc} . In some literature, organic carbon is lumped with overall organic matter and the property is referred to as fraction of organic matter, f_{om} . The fraction of organic carbon can be calculated from the fraction of organic matter by the following empirical (i.e., much scatter!) equation:

$$f_{oc} = 0.58 f_{om}$$

Typical organic carbon contents range from 1% to 6% ($f_{oc} = 0.01$ to 0.06) for near-surface soils and from $<0.07\%$ to perhaps 1% (f_{oc} from <0.0007 to 0.01) for aquifer materials.

Aerobic and anaerobic terminal electron acceptors in groundwater

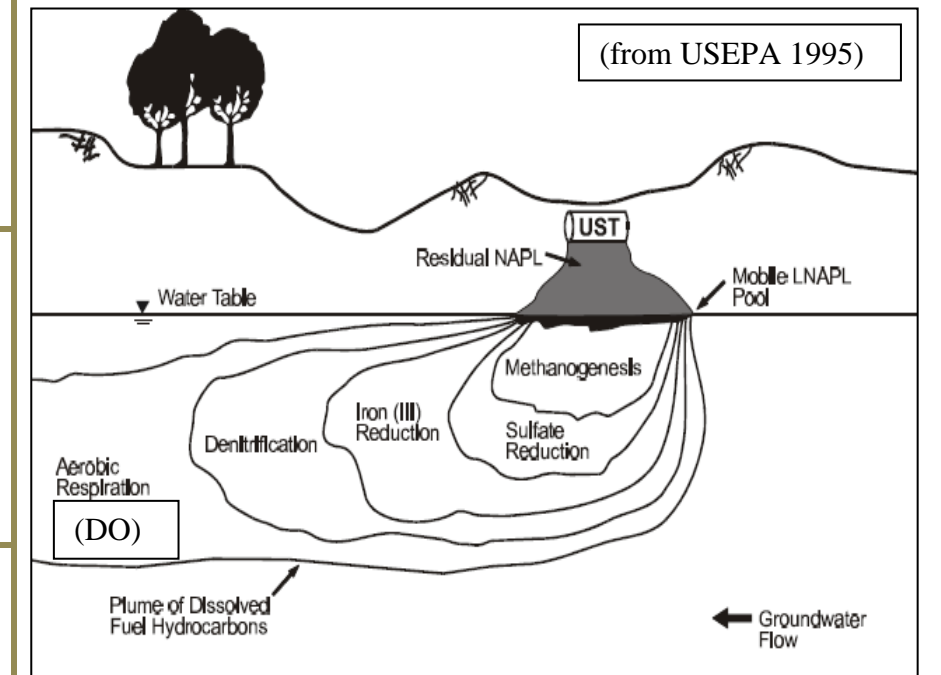

Aerobic - Dissolved Oxygen (DO) is the most preferred terminal electron acceptor (TEA) relative to others (nitrate, ferric iron, sulfate) used by microorganisms for the biodegradation of contaminants. If DO is present in ground water at concentrations above 0.5 mg/L, aerobic biodegradation is the predominant microbial process.

Anaerobic - Dissolved Oxygen (DO) At DO concentrations below 0.5 mg/L, anaerobic microbes can function and reductive dechlorination can occur. After depletion of DO, anaerobic microorganisms will utilize nitrate as the TEA, followed by manganese (not shown in above diagram), then ferric iron (Fe^{3+}), then sulfate, and finally carbon dioxide. Measurements of DO concentrations in monitoring wells during each sampling event at a contaminated site provide essential information regarding the availability of geochemical conditions to support reductive dechlorination through microbial degradation processes.

Section 7.0 Additional Topics Integral to Proper Investigations

7.1 Behavior of Organic Contaminants in the Subsurface

7.1.1 Introduction

When an organic contaminant is released to the subsurface, it will eventually equilibrate itself between two phases in the saturated zone (soil and water) and among three phases in the unsaturated zone (soil, water, and pore air). The precise distribution of the chemical among these phases is primarily dependent on two properties of the chemical, Organic Carbon Partition Coefficient (K_{OC}) and Henry's Law Constant (K_H), and one property of the soil matrix, the content of organic carbon. (Another phase, Non-Aqueous Phase Liquid, might also be present to complicate matters. See below for further details).

This section outlines how to:

1. Calculate the percentage of contaminant mass in each of the three phases -- soil, water, air (Section 7.1.3)
2. Calculate concentrations of the contaminant in soil, water, and pore gas knowing any one of the three concentrations (Section 7.1.4).
3. Determine the velocity of the contaminant in the groundwater with respect to the velocity of the groundwater itself (the velocity of the contaminant is retarded with respect to the velocity of groundwater) (Section 7.1.5).
4. Estimate the effect equilibrium partitioning has on prolonging cleanup time-frames.

If a NAPL (non-aqueous phase liquid or "free product") is present in either the vadose zone or the saturated zone, the equations presented in Sections 7.1.3 through 7.1.6 do not apply to the region of soil or aquifer in the vicinity of the NAPL. Section 7.1.7 discusses this problem in more detail.

7.1.2 Definitions

M_s	=	Mass of contaminant in soil phase [mg]
M_w	=	Mass of contaminant in water phase [mg]
M_a	=	Mass of contaminant in air phase [mg]
M_T	=	Total mass of contaminant [mg]
f_s	=	Fraction of contaminant mass sorbed to soil
f_w	=	Fraction of contaminant mass dissolved in water
f_a	=	Fraction of contaminant mass in soil air

October 2014 ADEQ Waste Programs Division
Site Investigation Guidance Manual

f_{oc}	=	Fraction of organic carbon in a soil
f_{om}	=	Fraction of organic matter in a soil
C_w	=	Concentration of contaminant in water phase [$\mu\text{g}/\text{cm}^3$ (= mg/L)]
C_a	=	Concentration of contaminant on air phase [$\mu\text{g}/\text{cm}^3$ (= mg/L)]
C_T	=	Lab-reported concentration of a contaminant in a soil sample analyzed by standard methods [$\mu\text{g}/\text{g}$ (= mg/kg)]
C_s	=	True concentration of contaminant in soil phase [$\mu\text{g}/\text{g}$ (= mg/kg)]
K	=	Hydraulic conductivity (cm/sec)
i	=	Hydraulic gradient
v	=	Darcy velocity (cm/sec), or equivalently, specific discharge ($\text{cm}^3/\text{cm}^2\text{-sec}$)
v_p	=	Actual groundwater velocity (cm/sec)
v_c	=	Contaminant velocity (cm/sec)
K_p	=	Soil partition coefficient (also often referred to as the soil distribution coefficient, K_d) [cm^3/g]
K_{ow}	=	Octanol-water partition coefficient
K_{oc}	=	Organic carbon partition coefficient [cm^3/g]
H	=	Henry's Law Constant [$\text{atm}\cdot\text{m}^3/\text{mol}$]
K_H	=	Dimensionless Henry's Law Constant
p	=	Vapor pressure (mm Hg)
s	=	Solubility (mg/L)
R_g	=	Universal gas constant, $8.2054 \times 10^{-5} \text{ atm}\cdot\text{m}^3/\text{deg}\cdot\text{mol}$
T	=	Temperature ($^{\circ}\text{Kelvin}$)
ρ	=	Particle density of soil or aquifer material (g/cm^3)
ρ_b	=	Dry bulk density of soil (g/cm^3)
n	=	Porosity of soil or aquifer material
n_e	=	Effective porosity of an aquifer
θ_s	=	Volume fraction of porosity containing water
R	=	Retardation factor

7.1.3 Distribution of Contaminant Mass in the Soil, Water, and Air Phases

For a one-centimeter volume of soil or aquifer:

$$M_w = C_w n \theta_s \quad (1)$$

$$M_a = C_a n (1-\theta_s) \quad (2)$$

$$M_s = C_s (1-n) \rho = C_s \rho_b \quad (3)$$

$$M_T = M_s + M_w + M_a \quad (4)$$

Substituting (1), (2), and (3) into (4) yields:

$$M_T = C_s (1-n) \rho + C_w n \theta_s + C_a n (1-\theta_s) \quad (5)$$

Consider now the equilibrium partitioning of a chemical between air /water and soil/water. Assume that a 1 cm³ volume of air overlies a 1 cm³ volume of water containing a dissolved organic chemical.

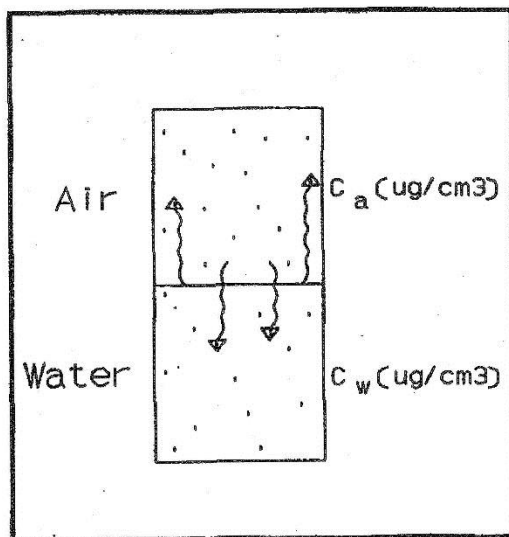

Some molecules of the dissolved organic chemical will escape from the water surface into the air phase. Eventually, the rate of molecules escaping from the water phase will equal the rate of air phase molecules rebounding back into the water. In other words, the concentrations of the chemical in the air phase, C_a , and water phase, C_w , will become constant; the two concentrations represent an equilibrium state of the chemical between water and air. The ratio between these two equilibrium concentrations is termed the Dimensionless Henry's Law Constant, K_H .

$$K_H = \frac{C_a}{C_w} \quad \text{OR} \quad C_a = K_H C_w \quad (6)$$

Larger values of K_H mean that a chemical has a greater affinity for the air phase while very small values of K_H indicate that the chemical largely resides in the water phase. For example, the values of K_H for Freon 113, trichloroethylene, and DDT are 21.5, 0.421, and 0.0011, indicating extreme, moderate, and minuscule volatility, respectively.

Please Note: Henry's Law Constant may be expressed in a variety of units. The formulation in these notes uses the Dimensionless Henry's Law Constant, K_H . Often Henry's Law Constant (H) is expressed in units of atm-m³/mol. Convert to K_H as follows:

$$K_H = \frac{H}{R_g T} = \frac{H}{(8.2054 \times 10^{-5}) (T)} \quad (7)$$

$$\text{If } T = 293^{\circ}K \quad (= 20^{\circ}C \text{ OR } 68^{\circ}F)$$

$$K_H = 41.59 H \quad (8)$$

The water/soil interaction is somewhat more complex. Consider the diagram below indicating a volume of soil in contact with water:

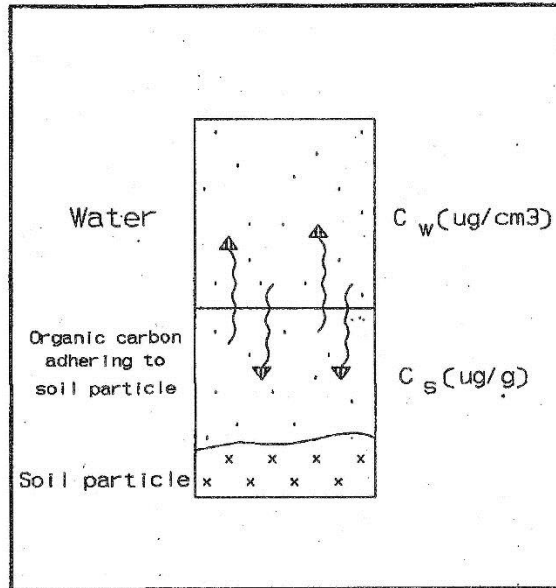

In a soil-water system, an organic chemical eventually reaches equilibrium between the soil and water phases in an analogous manner to air-water partitioning. The equilibrium equation describing the relationship between soil and water phases can be written as:

$$K_p = \frac{C_s}{C_w} \quad \text{or} \quad C_s = K_p C_w \quad (9)$$

where K_p is the Soil Absorption Partition Coefficient (units are cm^3/g). This linear relationship between the soil concentration and the water concentration holds for many organic chemicals and is known as a linear isotherm. (The linear isotherm is a special case of the Freundlich isotherm, defined as $C_s = K_p C_w^{1/b}$).

The equilibrium relationships set forth in equations (6) and (9) are now substituted into equation (5) to yield:

$$M_T = K_p C_w (1-n) \rho + C_w n \theta_s + K_H C_w n (1-\theta_s) \quad (10)$$

Typically, unless batch or column tests of the particular soil have been performed in the laboratory, K_p is not directly known. However, as we shall now see, K_p is dependent on two other properties, symbolized as f_{oc} and K_{oc} , which can be used to estimate K_p without performing laboratory sorption tests.

The first of these properties is f_{oc} , the fraction of organic carbon in the porous medium. Research has shown that in the sorption process the organic chemical actually moves into

organic matter which adheres to the mineral surfaces of soil and aquifer particles. A portion of the organic matter consists of active organic carbon which is the actual sorbing medium. The greater the organic carbon content of the soil, the greater the amount of chemical sorbed by the soil. In fact, the sorption relationship is linear - doubling the amount of soil organic carbon will double the chemical concentration in the soil. The content of organic carbon in a soil is usually represented as the weight fraction, f_{oc} . In some literature, organic carbon is lumped with overall organic matter and the property is referred to as fraction of organic matter, f_{om} . The fraction of organic carbon can be calculated from the fraction of organic matter by the following empirical (i.e., much scatter!) equation:

$$f_{oc} = 0.58 f_{om} \quad (11)$$

Typical organic carbon contents range from 1% to 6% ($f_{oc} = 0.01$ to 0.06) for near-surface soils and from <0.07% to perhaps 1% (f_{oc} from <0.0007 to 0.01) for aquifer materials.

The second property affecting K_p is the inherent difference among organic chemicals in their affinity for the organic carbon phase of the soil. The more hydrophobic the chemical (dependent on the chemical's degree of non-polarity), the greater the affinity of the chemical for soil organic carbon than pore water. (That is, the chemical would rather reside in the carbon than the water).

This affinity for organic carbon is represented by K_{oc} , the Organic Carbon Partition Coefficient. The greater the value of K_{oc} , the greater the chemical's sorption in soil.

The above two relationships allow us to calculate K_p without actually performing batch or column tests of the soil. First, an estimate or laboratory determination of a soil's f_{oc} is needed. Then, the K_{oc} of the organic chemical is looked up (tabulations may be found in various references). The properties are related thusly:

$$K_p = K_{oc} f_{oc} \quad (12)$$

Physically, the K_{oc} value for a chemical can be determined from a column or batch test by measuring C_s , C_w , and f_{oc} and applying equations (9) and (10) in reverse to calculate K_{oc} . The K_{oc} value can also be determined from two surrogate properties that reflect the hydrophobicity of a chemical -- the solubility, s , and the Octanol-Water Partition Coefficient, K_{ow} . Equations showing how to calculate K_{oc} from S or K_{ow} are given in Lyman et al., Handbook of Chemical Property Estimation Methods, 1982. The Octanol - Water Partition Coefficient, K_{ow} , is the ratio of the concentration of an organic chemical in n - octanol to its concentration in water in a two-phase system of octanol - water. The K_{ow} is a surrogate for K_{oc} because octanol is an organic phase and serves as a sink for hydrophobic chemicals in much the same way that organic carbon does in soil. Although s can be used to calculate K_{oc} , the K_{ow} if available is a better estimator for calculating K_{oc} .

Substituting (12) into (10) then yields:

$$M_T = K_{oc} f_{oc} C_w (1-n) \rho + C_w n \theta_s + K_H C_w n (1-\theta_s) \quad (13)$$

The mass fractions of the contaminant in the soil, water, and air phases may now be readily calculated as follows:

Mass fraction of contaminant in soil:

$$f_s = \frac{M_s}{M_T} = \frac{K_{oc} f_{oc} C_w (1-n) \rho}{K_{oc} f_{oc} C_w (1-n) \rho + C_w n \theta_s + K_H C_w n (1-\theta_s)} \quad (14)$$

Canceling C_w in the numerator and denominator yields:

$$f_s = \frac{K_{oc} f_{oc} (1-n) \rho}{K_{oc} f_{oc} (1-n) \rho + n \theta_s + K_H n (1-\theta_s)} \quad (15)$$

Mass fraction of contaminant in water:

$$f_w = \frac{M_w}{M_T} = \frac{C_w n \theta_s}{K_{oc} f_{oc} C_w (1-n) \rho + C_w n \theta_s + K_H C_w n (1-\theta_s)} \quad (16)$$

$$f_w = \frac{n \theta_s}{K_{oc} f_{oc} (1-n) \rho + n \theta_s + K_H n (1-\theta_s)} \quad (17)$$

Mass fraction of contaminant in air:

$$f_a = \frac{M_a}{M_T} = \frac{K_H C_w n (1-\theta_s)}{K_{oc} f_{oc} C_w (1-n) \rho + C_w n \theta_s + K_H C_w n (1-\theta_s)} \quad (18)$$

$$f_a = \frac{K_H n (1-\theta_s)}{K_{oc} f_{oc} (1-n) \rho + n \theta_s + K_H n (1-\theta_s)} \quad (19)$$

Note that in the saturated zone, where no pore air is assumed to exist ($\theta_s = 1$), the rightmost term of the denominator reduces to zero and the value for f_a becomes zero.

Default values for many of the equation variables are listed in Section 6.0 of ADEQ's [Soil Vapor Sampling Guidance](#). K_{oc} and K_H (as well as H, S, and p) values for many common soil and groundwater contaminants. Values are for 20°C unless noted. Vapor pressure, Henry's Law Constant, and viscosity are often highly temperature dependent, so ambient soil temperature may be important to consider if significantly different from 20°C.

Example

Q. Assume that a spill of TCE has occurred and the chemical now resides in the vadose zone. The vadose zone soil has a porosity of 30% and an organic carbon content of 0.1%. The soil has a bulk density of 1.5 g/cm³ and is fairly dry - water occupies 30% of the pore spaces. What is the fraction of TCE mass (a) sorbed to soil, (b) dissolved in the pore water, and (c) present as a vapor in the pore air?

A. The following data was collected for TCE:

$$K_{oc} = 126$$

$$K_H = 0.3$$

The organic carbon content of the soil is 0.1%, so $f_{oc} = 0.001$.

Porosity of soil is 30%: $n = 0.30$

Percent water-filled porosity is 30%: $\theta_s = 0.30$

Bulk density ρ_b is 1.5 g/cm³, therefore particle density is:

$$\rho = \rho_b / (1 - n) : \rho = 2.14$$

The denominator in all three mass fraction equations is:

$$K_{oc} f_{oc} (1 - n) \rho + n \theta_s + K_H n (1 - \theta_s) =$$
$$0.1887 + 0.0900 + 0.0630 = 0.3417 \quad (20)$$

Therefore,

$$f_s = \frac{0.1887}{0.3417} = 0.552$$

$$f_w = \frac{0.0900}{0.3417} = 0.263$$

$$f_a = \frac{0.0630}{0.3417} = 0.185$$

Interestingly, even at this low organic carbon level, more than half (55.2 %) of the TCE mass resides in the soil (leaving the other half of the mass split between water and air).

As a few calculations with equations (15), (17), and (19) will demonstrate, the K_{oc} and K_H of a chemical, as well as the organic carbon content of the soil, greatly affect the distribution of the contaminant in the soil, water, and air phases. As an example of the range of variation, the virtually all DDT resides in the soil phase, while vinyl chloride will largely partition to the air phase if a reasonable volume of air-filled porosity exists.

7.1.4 Calculation of Concentrations

A. Given only the water concentration, C_w :

$$C_s = K_{oc} f_{oc} C_w \quad (21)$$

$$C_a = K_H C_w \quad (22)$$

Recall that the correct units for C_w , C_a , and C_s are $\mu\text{g} / \text{cm}^3$ (= mg/L), $\mu\text{g}/\text{cm}^3$ (= mg /L), and $\mu\text{g}/\text{g}$ (= mg / kg), respectively.

B. Given only the air concentration, C_a (for example, from a soil gas analysis):

$$C_w = C_a / K_H \quad (23)$$

$$C_s = \frac{K_{oc} f_{oc} C_a}{K_H} \quad (24)$$

C. If only the concentration from a soil sample is known:

For this case, calculations for the soil, water, and air phases are not as direct. This is because the laboratory procedure for analyzing a soil usually involves driving off or stripping the chemical from all three phases during analysis. For example, one typical laboratory procedure involves cutting a small disk of soil out of the sample core, adding methylene chloride or some other solvent, and shaking the two together vigorously. This procedure effectively strips organics from all three phases within the soil sample. (Since organics in all three phases are removed, it is obvious that lab-reported soil concentrations can vary if there has been volatilization of the soil during sampling, packaging, transport or analysis.) The concentration of a chemical in a soil sample analyzed by this laboratory procedure can therefore be expressed as:

$$C_T = \frac{M_T \text{ in one cm}^3 \text{ of soil}}{\text{Dry weight of one cm}^3 \text{ of soil}} \quad (25)$$

$$C_T = \frac{M_s + M_w + M_a}{\text{Dry weight of soil}} \quad (26)$$

The dry weight of soil refers to oven - dry. If the lab uses air-dry weight, up to 6-7% moisture may still be present, causing the lab reported concentration to be underestimated.

The numerator of equation (26) has already been derived in equation (13), yielding the following equation:

$$C_T = \frac{K_{oc} f_{oc} C_w (1 - n) \rho + C_w n \theta_s + K_H C_w n (1 - \theta_s)}{(1 - n) \rho} \quad (27)$$

$$C_T = \frac{C_w [K_{oc} f_{oc} (1-n) \rho + n \theta_s + K_H n (1 - \theta_s)]}{(1 - n) \rho} \quad (28)$$

Solving for C_w yields:

$$C_w = \frac{C_T (1 - n) \rho}{K_{oc} f_{oc} (1 - n) \rho + n \theta_s + K_H n (1 - \theta_s)} \quad (29)$$

Air and true soil concentrations readily follow:

$$C_a = K_H C_w \quad (30)$$

$$C_s = K_{oc} f_{oc} C_w \quad (31)$$

Example

Q. A soil boring is properly collected and preserved from the site described in the previous example. The laboratory follows the analytical procedure described above and reports a TCE concentration of 2.30 mg /kg from the sample. What are the corresponding water and air concentrations in the soil? What is the true soil (sorbed) concentration?

A. The concentration of the chemical in water is calculated from equation (29):

$$C_w = \frac{C_T (1 - n) \rho}{K_{oc} f_{oc} (1 - n) \rho + n \theta_s + K_H n (1 - \theta_s)}$$

In the earlier example, we already calculated the denominator of the above equation as 0.3417, therefore,

$$C_w = \frac{(2.30)(1 - 0.30)(2.14)}{0.3417} = 10.08 \text{ ug/cm}^3 = 10.08 \text{ mg/L}$$

$$C_w = 10,080 \text{ ug/L}$$

$$C_a = K_H C_w = (0.300)(10.08 \text{ mg/L}) = 3.02 \text{ mg/L}$$

$$C_s = K_{oc} f_{oc} C_w = (126 \text{ cm}^3/\text{g})(0.001)(10.08 \text{ ug/cm}^3)$$

$$= 1.27 \text{ ug/g} = 1.27 \text{ mg/kg}$$

Note the difference between the true sorbed concentration in the soil (1.27 mg/kg) and the bulk soil concentration as reported by the laboratory (2.30 mg/kg).

7.1.5 Retardation of an Organic Chemical in Groundwater

Darcy's Law states that the specific discharge (Darcy velocity) of groundwater in an aquifer is the product of the hydraulic conductivity of the aquifer and the hydraulic gradient:

$$v = Ki \tag{32}$$

The actual fluid velocity of the groundwater is obtained by dividing the Darcy velocity by the effective porosity of the aquifer:

$$v_p = \frac{Ki}{n_e} \tag{33}$$

The retardation factor, R, for an organic chemical in groundwater is calculated as follows:

$$R = 1 + \frac{\rho_b K_p}{n_e} = 1 + \frac{\rho_b K_{oc} f_{oc}}{n_e} \tag{34}$$

The retardation factor defined in equation (34) is valid only if sorption of the organic chemical is described by the relationship $C_s = K_p C_w$; that is, sorption must follow a linear isotherm. In fact, the calculations outlined in this entire set of notes are predicated on the assumption of sorption linearity (which conveniently holds for a great many organic compounds).

Once the retardation factor is calculated, the relative velocity of the chemical in groundwater with respect to the groundwater itself is easily obtained:

$$\frac{v_c}{v_p} = \frac{1}{R} \quad (35)$$

Retardation factors for selected chemicals at different soil organic carbon contents (0.07%, 0.2%, and 1%) are tabulated in Appendix C. Appendix C also shows the mass fraction of each chemical sorbed to aquifer materials for each organic carbon content.

Example

Q. Assume that the soil described in the above two examples is saturated with groundwater. Calculate the retardation factor for TCE and determine the relative velocity of the dissolved TCE as it moves through the aquifer in comparison to the velocity of the groundwater itself.

A. Recall that $\rho = 2.14 \text{ g/cm}^3$ and $\rho_b = 1.5 \text{ g/cm}^3$, $n_e = 0.30$, $f_{oc} = 0.001$, and $K_{oc} = 126$.

$$R = 1 + \frac{\rho_b K_{oc} f_{oc}}{n_e}$$

$$R = 1 + \frac{(1.5)(126)(0.001)}{0.30} = 1.63$$

$$\frac{v_c}{v_p} = \frac{1}{R} = 0.61$$

Therefore, TCE travels at 61% of the velocity of groundwater, or looking at it another way, in the time it takes groundwater to travel 100 feet, the dissolved TCE in the groundwater will travel only 61 feet.

7.1.6 Effect of Equilibrium Partitioning on Groundwater Cleanups

Because of equilibrium partitioning, an organic contaminant dissolved in groundwater travels slower than the groundwater, and a certain percentage of the contaminant is tied up in the soil phase rather than dissolved in groundwater. Therefore, groundwater cleanup plans that do not account for these phenomena will underestimate both contaminant mass and cleanup timeframes.

Due to variations in lithology and groundwater flow regime, the most precise method of estimating the effects of sorption on cleanup timeframes is through the use of a digital groundwater flow and solute transport model. If such a model is to be accurate, it should be based upon an accurate representation of spatial and temporal variation in hydraulic and chemical source parameters.

For the purpose of these notes, however, we desire to know the effect of equilibrium partitioning on cleanup timeframes in a more general way, so that these effects can be roughly estimated without resorting to a detailed groundwater model of the site. In the following discussion, we will perform a highly simplified analysis using a one-dimensional computer model, then relate this result to the retardation factor.

Let us proceed by first considering an aquifer containing a contaminant plume of TCE with the following characteristics:

Elliptical plume shape, 1 mi x 1/4 mi (5,280 ft by 1,320 ft)
Thickness of plume = 100 ft.
Porosity of aquifer: $n = 0.30$
Average TCE concentration in plume = 400 $\mu\text{g} / \text{L}$

We may now calculate the volume of groundwater in the plume, as well as the mass and volume of TCE.

Volume of groundwater in the plume

$$\begin{aligned} V_w &= (\text{Area}) (\text{Thickness}) (\text{Porosity}) = (\pi ab)(z)(n) \\ &= (\pi \times 2,640 \text{ ft} \times 660 \text{ ft})(100 \text{ ft})(0.30) \end{aligned}$$

$$\begin{aligned} V_w &= 1.642 \times 10^8 \text{ ft}^3 \\ &= 3,770 \text{ acre ft} \quad (\text{Conversion: } 1 \text{ acre ft} = 43,560 \text{ ft}^3) \\ &= 4.652 \times 10^9 \text{ L} \quad (\text{Conversion: } 1 \text{ L} = 0.0353 \text{ ft}^3) \end{aligned}$$

Mass of TCE in the plume

$$M_w = V_w C_w \tag{36}$$

$$\begin{aligned} &= (4.652 \times 10^9 \text{ L})(400 \mu\text{g/L})(\text{kg}/10^9 \mu\text{g}) \\ &= 1,861 \text{ kg of TCE} \\ &= 4,103 \text{ lb of TCE (Conversion: } 2.205 \text{ lb} = 1 \text{ kg)} \end{aligned}$$

Volume of TCE in the plume

$$\begin{aligned}
 V_{TCE} &= \frac{M_w}{\rho_{TCE}} = \frac{1861 \text{ kg}}{(1.46 \text{ g/cm}^3) (1000 \text{ cm}^3/\text{L}) (.001 \text{ kg/g})} \\
 &= 1275 \text{ L} \\
 &= 336.6 \text{ gallons} \quad (\text{Conversion: } 3.785 \text{ L} = 1 \text{ gal})
 \end{aligned}
 \tag{36}$$

Note: This indicates how little of a chemical, in this case about six 55-gal drums, is needed to substantially contaminate a vast volume of groundwater.

A. Scenario 1: Extraction Without Retardation of TCE

Assume four extraction wells are constructed, each of which pumps 1,000 gal/min. Also, assume (unrealistically) that the extraction wells remove groundwater only from the plume area (i.e., the pumping does not affect groundwater beyond the limits of the plume).

$$\begin{aligned}
 Q &= 4000 \frac{\text{gal}}{\text{min}} \times 3.786 \frac{\text{L}}{\text{gal}} \times \frac{60 \text{ min}}{\text{hr}} \times \frac{24 \text{ hr}}{\text{day}} \times \frac{365 \text{ day}}{\text{yr}} \\
 &= 7.9594 \times 10^9 \text{ L/yr}
 \end{aligned}$$

In order to reduce the concentration of TCE in the aquifer from 400 µg/L to the MCL of 5 µg/L, 98.75% of the TCE mass in the plume volume would have to be pumped out (395/400 = 0.9875). That is, 98.75% of the volume of contaminated water which would contain 98.75% of the mass of the TCE would have to be removed. If uncontaminated water were then added and mixed with the remaining contaminated water inside of the aquifer, a TCE concentration of 5 µg/L would result. (Obviously, this assumption is unrealistic because an aquifer doesn't behave like a large mixing cell. It would be impossible to pump 98.75% of the groundwater out, replace with an equal amount of clean water, and uniformly mix with the 1.25% of TCE-contaminated water that was not pumped from the plume volume).

Performing this calculation (mindful of the limitations of this analysis), yields a time to cleanup of 0.58 year.

$$t = \frac{V}{Q} = \frac{(4.652 \times 10^9 \text{ L}) (0.975)}{7.9594 \times 10^9 \text{ L/yr}} = 0.58 \text{ yr}$$

Summary:

Pore Volumes Removed = 0.9875
Mass of TCE Removed = 1,838 kg
Cleanup time = 0.58 yr.
Volume of water pumped = 4.59×10^9 L
= 3,721 acre feet

This calculation yields a minimum estimated cleanup time, but this could not be achieved in a practical sense because of the unrealistic assumptions built into the calculation.

B. Scenario 2: Extraction with Consideration of Retardation

In this scenario, we consider the effect of retardation. To simplify the problem, the contaminated groundwater is assumed to flow from the bottom to the top of the aquifer, where water is then removed. In other words, the contaminant plume is considered to be a column with elliptical cross-section and a height of 100 feet. Clean water is drawn into the bottom of the column while contaminated water is removed from the top. The organic carbon content of the aquifer is assumed to be 0.1% ($f_{oc} = 0.001$); the particle density used in the Section V example ($\rho = 2.14 \text{ g/cm}^3$) is maintained. By equation (17), the mass fraction of TCE in water can be calculated as:

$$f_w = \frac{(0.30) (1)}{(126) (0.001) (1-0.30) (2.14) + (0.3) (1)}$$

$$f_w = 0.614$$

Thus the dissolved mass of TCE in the plume, 1861 kg (determined previously), represents only 61.4% of the total system mass. The other 38.6% of TCE, or 1170 kg, is sorbed to aquifer material within the plume. A total of 3031 kg of TCE therefore exists in the system. If this additional mass is to be removed from the system, cleanup times will obviously increase.

Using the computer, program BI0-1D, a column 100 feet long (the thickness of the aquifer) and a pumping rate of 4,000 gal/min were simulated. The 100 foot column was simulated by 50 2-foot cells. Simulation results for TCE are shown below (results for PCE, with a $K_{oc} = 364$, are also shown):

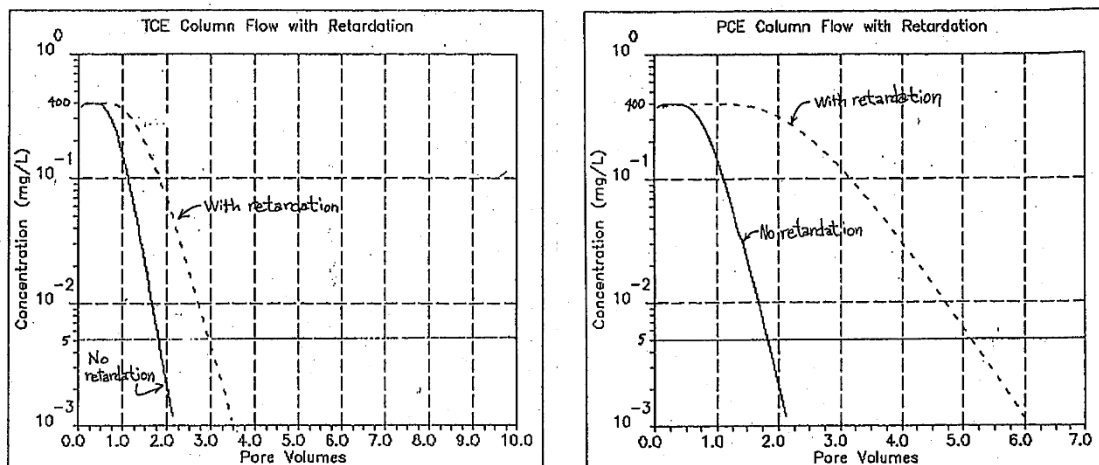

All of the above breakthrough curves include the effect of dispersion. As the TCE graph shows, to reduce TCE from 400 $\mu\text{g/L}$ to 5 $\mu\text{g/L}$ with no sorption would require a flow of 1.80 pore volumes of water through the column. When sorption is considered, 2.95 pore volumes of water would be required. Thus, in order to purge the aquifer of both dissolved and sorbed TCE, 1.63 times as much pumping is needed. Not coincidentally, this is exactly equal to the Retardation Factor.

Summary: The Retardation Factor can be used to estimate the minimum increase in cleanup time due to carbon-based sorption. For example, if a groundwater model indicates that 10 years would be required to clean up a TCE plume if sorption is neglected, at least 16.3 years would be required with sorption considered (assuming the same organic carbon content used in this example).

Please Note: Additional retardation may occur due to flow through lower permeability layers (Bouwer, H., "Simple Derivation of the Retardation Equation and Application to Preferential Flow and Macrodispersion, 11, *Groundwater*, Vol. 2.9, No. 1, Jan. -Feb. 1991), sorption directly onto mineral surfaces (Ball, W. P. and P. V. Roberts, "Long-Term Sorption of Halogenated Organic Chemicals by Aquifer Material: 1. Equilibrium," *Environmental Science & Technology*, Vol. 25, No. 7, 1991, pp. 1223-1237), and diffusion into and out of dead end pores and stagnant "pockets" within the aquifer. None of these retardation effects are fundamentally related to carbon-based sorption.

7.1.7 Behavior of NAPLs and Effect on Mass Distribution Equations

7.1.7.1 NAPL behavior in the subsurface:

If a NAPL (non-aqueous phase liquid or "free product") is present in either the vadose zone or the saturated zone, the equations presented in Sections 7.1.3 through 7.1.6 do not apply to the region of soil or aquifer in the vicinity of the NAPL.

Both LNAPL (light non-aqueous phase liquid or a "floaters") and DNAPL (dense non-aqueous phase fluid or a "sinker") may occur as mobile fluid or as residual, relatively immobile fluid in the unsaturated and saturated zones. Mobile fluid continues to move downward under the influence of gravity. However, once the NAPL breaks up or disperses enough, it will become immobilized by capillary forces and exist as discontinuous droplets or ganglia in the small interstices of the soil matrix.

LNAPLs include petroleum fuels (gasoline, diesel, oil) and unchlorinated aliphatic and aromatic hydrocarbons such as benzene, xylene, hexane, ketones, ethers, etc. If enough LNAPL is dispensed so that it reaches the water table, it distributes itself within the porous medium above the water table.

Most halogenated fluids are DNAPLs - trichloroethene (TCE), tetrachloroethene (PCE), trichloroethane (TCA), methylene chloride, carbon tetrachloride, trichlorotrifluoroethane (Freon-113), pentachlorophenol, and many others. If DNAPLs reach the water table, they tend to sink through the aquifer until totally dissolved in the groundwater or until impeded by less permeable zones (including bedrock). The sinking of DNAPL through the water table does not begin until the pressure exerted by the mound of accumulated DNAPL is sufficient to displace water held in the capillary fringe above the water table. When this happens, the DNAPL penetrates the saturated zone as "fingers" rather than as uniform infiltration over the entire area of the DNAPL mound. The locations and diameters of these fingers are unpredictable. The fingers can be very small, thus creating extreme difficulty in verifying the presence and transport of DNAPL in the saturated zone.

If DNAPL reaches a less permeable zone in the aquifer as it moves down, it will spread laterally, forming disk-shaped pools. These will flow in a downslope direction (which may be different than the groundwater flow direction) or accumulate in low spots (for instance, in bedrock).

7.1.7.2 NAPL Mobility

How do NAPLs move in the subsurface with respect to water? Consider Darcy's Law:

$$V = Ki$$

- K is the permeability of a porous medium to movement of a fluid.
- When the fluid is water, K is referred to as the hydraulic conductivity.
- K, in reality, takes into account both the medium and the fluid:

$$K = \frac{k g \rho}{\mu}$$

where: k = intrinsic permeability, a property of the medium only (cm^2)
 g = acceleration due to gravity (cm/sec^2)
 ρ = mass density of the fluid (g/cm^3)
 μ = dynamic viscosity of the fluid ($\text{dyne}\cdot\text{sec}/\text{cm}^2$ or centipoise)

- For water at 20°C , $\rho/\mu = 1$ (actually 0.996)

Therefore, the relative velocity of a NAPL to water in the subsurface is indicated by the fraction ρ/μ . ($= 1/v = 1/\text{Kinematic Viscosity}$, since μ/ρ is defined as the kinematic viscosity).

Example: TCE

$$\rho = 1.46 \text{ g}/\text{cm}^3$$
$$\mu = 0.57 \text{ centipoise}$$

$$\text{"NAPL mobility"} = \rho/\mu = 2.56$$

TCE as a NAPL will travel 2.56 times as fast as water in a porous medium.

7.1.7.3 Effect of NAPLs on Mass Distribution Equations

In the immediate region of the NAPL, mass exists in the pure fluid phase that isn't accounted for by the equilibrium equations derived previously. Calculations based on measured concentrations of the organic compound in the soil, water, or air phases will therefore underestimate the total mass in the system. Also, in the vadose zone, the air concentration of the organic chemical in the vicinity of the NAPL will be dependent on the vapor pressure of the chemical rather than the Henry's Law Constant.

The total NAPL mass in the system could theoretically be determined if the dimensions and residual saturation of all NAPL occurrence could be obtained. This is sometimes possible for LNAPLs, but is presently beyond the limits of technology for most DNAPL situations. Often the only way of approaching this problem is an estimate of the volume of NAPL disposed or released (if such information is even available).

Because DNAPLs exist in the saturated zone as either thin, vertical fingers or flat, disclike pools very little NAPL surface area is exposed to moving groundwater. This, therefore, limits the amount of the chemical that can dissolve from the DNAPL into the groundwater moving past it. Hence, concentrations of a DNAPL chemical in groundwater are much lower than saturation values, even short distances from the DNAPL source. Experiments and field data indicate that if DNAPL chemicals exist in groundwater at concentrations 1% to 2% of saturation values, DNAPL sources should be suspected.

Example: A groundwater analysis indicates a PCE concentration of 5,500 $\mu\text{g/l}$.

Q. Should a possible DNAPL source be suspected?

Saturation value of PCE in water = 200,000 $\mu\text{g/l}$: 2% saturation level = 4,000 $\mu\text{g/l}$

A. A DNAPL source of PCE in the saturated zone may be present.

Table 7.1 Solubility Values for Selected Chemicals

Contaminant	Solubility (mg/L)	Contaminant	Solubility (mg/L)
1,1,1-Trichloroethane*	1,300	Fluorene	1.90E+00
1,1,1,2-Tetrachloroethane	3000	HCH (gamma) Lindane	8.00E+00
1,1,2-Trichloroethane	4400	HCH-technical	8.00E+00
1,1-Dichloroethane	5100	Heptachlor	1.80E-01
1,1-Dichloroethylene(DCE)	2300	Heptachlor epoxide	2.00E-01
1,2,4-Trimethylbenzene	5.70E+01	Hexachlorobenzene	6.20E-03
1,2-Dibromoethane	3400	Hexachlorobutadiene	3.20E+00
1,2-Dichlorobenzene (ortho)	160	Hexachlorocyclopentadiene	1.80E+00
1,2-Dichloroethane (DCA)	8500	Hexachloroethane	5.00E+01
1,2-Dichloropropane	2800	Methyl bromide	12000
1,3,5-Trimethylbenzene	48	Methyl ethyl ketone	2.68E+05
1,3-Butadiene	7.35E+02	Methyl isobutyl ketone	1.90E+04
1,3-Dichloropropene	2800	Methyl <i>tert</i> -butyl ether (MTBE)	1.50E+05
1,4-Dichlorobenzene (para)	74	Methylcyclohexane	1.40E+01
1,4-Dioxane	1.00E+06	Methylene bromide	1.17E+04
2,4-Dinitrotoluene	2.70E+02	Methylene chloride	1.32E+04
2,6-Dinitrotoluene	3.52E+02	Naphthalene	3.10E+01
Acenaphthene	4.24E+00	n-Butylbenzene	1.38E+01
Anthracene	4.34E-02	n-Hexane	1.80E+01
Benzene	1800	Nitrobenzene	2.10E+03
Bis(2-ethylhexyl)phthalate (DEHP)	2.70E-01	n-Propylbenzene	1.38E+01
Bromodichloromethane	6700	Pyrene	1.35E-01
Bromoform	3100	sec-Butylbenzene	1.70E+01
Carbon disulfide	1200	Styrene	310
Carbon tetrachloride	790	tert-Butylbenzene	3.00E+01
Chlorobenzene	470	Tetrachloroethylene (PCE)	200
Chloroform	7900	Tetrahydrofuran	1.00E+06
Chrysene	1.60E-03	Toluene	530
<i>cis</i> -1,2-Dichloroethylene	3500	<i>trans</i> -1,2-Dichloroethylene	6300
Cumene (isopropylbenzene)	6.10E+01	Trichloroethylene (TCE)	1100
Cyclohexane	5.50E+01	Vinyl acetate	20000
Dibenzofuran	3.10E+00	Vinyl chloride	2.76E+03
Dibromochloromethane	4.40E+03	Xylenes (total) ³	160
Dichlorodifluoromethane	2.80E+02		
Dicyclopentadiene	1.80E+03		
Ethylbenzene	170		
Ethylene oxide	1.00E+06		

7.2 Geochemical Conditions in Groundwater

The geochemical conditions that prevail in the aquifer serve as indicators of the occurrence of degradation or attenuation of contaminants. Understanding aquifer geochemical conditions is important for the determination of aquifer capacity to degrade contaminants. Geochemical parameters and their significance are discussed below.

In most cases, a select group of parameters that indicate the geochemical environment (e.g., oxidation-reduction potential, dissolved oxygen, pH), identify geochemical regimes affecting contaminant degradation (e.g., nitrate, iron (II), sulfate, methane), or are products of contaminant degradation (e.g., ethane, ethene) will be measured in most samples. In addition to the measurement of geochemical parameters in groundwater samples, periodic monitoring of solid-phase electron acceptors, such as bioavailable iron, in aquifer materials may be useful at some sites to evaluate the supply of such materials relative to the mass of contaminants to be degraded. The geochemical parameters measured generally should be chosen based on the utility of the data for affecting site-related decisions (i.e., if no decisions would be changed based on the data, then the data need not be collected) (EPA, 2004).

7.2.1 Organics

Measurable changes in groundwater chemistry results when biodegradation of organic compounds occurs in the subsurface. By measuring these changes, it is possible to document and qualitatively assess the importance of natural attenuation (natural remediation) of contaminants at a given site. The geochemical parameters described below are indicators of the occurrence of biodegradation of contaminants in the subsurface by biologically mediated processes.

In general, reductive dechlorination occurs by sequential dechlorination from PCE to TCE to cis-DCE to vinyl chloride (VC) to ethene. During this process, the chlorinated hydrocarbon is typically used as an electron acceptor (not as a source of carbon), and chlorine atoms are sequentially removed and replaced with hydrogen atoms. In this case, biodegradation is an electron-donor limited process; (i.e., it is controlled by the availability of a source of carbon (for example, natural organic matter in the aquifer matrix). Chlorinated hydrocarbons can also undergo biodegradation though use as an electron donor, in which case the rate of reductive dechlorination is controlled by the availability of electron acceptors (e.g., nitrate, ferric iron, sulfate), or through cometabolic processes. Specific chemical indicator parameters are necessary to evaluate these processes, and form the basis for an understanding of reductive dechlorination processes at a site; they also represent an important component of the protocol for long term performance monitoring.

7.2.1.1 Terminal Electron Acceptors (TEA)

Degradation of organic contaminants in groundwater is accomplished by biochemical oxidation-reduction reactions where one compound (electron donor) loses electrons and is oxidized and the other compound (electron acceptor) receives electrons and is reduced. If the organic contaminant is oxidized, some other compound must be reduced. The compound that is reduced (receives or gains electrons) is termed a Terminal Electron Acceptor (TEA). Oxygen, nitrate, sulfate, and ferric iron (Fe^{+3}) minerals in the aquifer can serve as TEAs. The significance of the presence of these TEAs as geochemical footprints of microbial degradation is briefly described below.

Iso-concentration maps or distribution maps for all TEAs for each round of sampling would provide indications of the changes in contaminant plume configuration and allow interpretation of data in reference to degradation rates of contaminants in the aquifer. The changes in TEAs due to progression in biological degradation in a groundwater dissolved phase contamination plume are illustrated conceptually in Figure 7.1. As illustrated in the figure, available oxygen is consumed by microorganisms during the aerobic degradation resulting in anaerobic conditions in the core of the contamination plume and a zone of oxygen depletion along the outer margins of the plume. After dissolved oxygen has been depleted in groundwater, available nitrate (NO_3^-) will be used as an electron acceptor for anaerobic biodegradation.

Nitrate reduction is followed by the reduction of Mn^{+4} and Fe^{+3} (both are electron acceptors and are reduced to Mn^{+2} and Fe^{+2} , respectively). When strong reducing conditions prevail in groundwater after the depletion of oxygen, nitrate, and ferric iron, the available sulfate can be used as an electron acceptor for anaerobic degradation. Under very strong reducing conditions, methanogens (a group of anaerobes) use CO_2 as electron acceptor for biodegradation and produce methane.

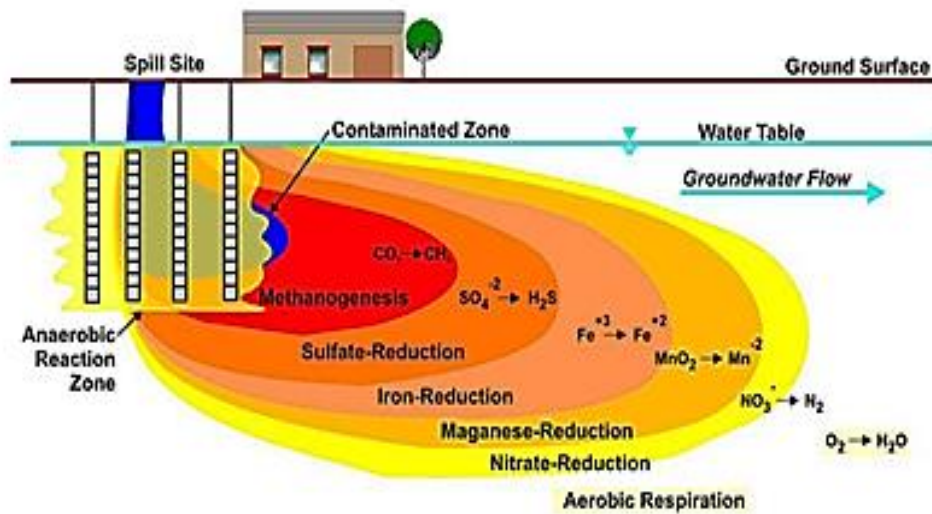

Figure 7.1- Site Model of Terminal Electron Acceptor (TEA) Zones in a groundwater contaminant plume (NJDEP, 2012).

Aerobic:

Dissolved Oxygen (DO) is the most preferred terminal electron acceptor (TEA) relative to others (nitrate, ferric iron, sulfate) used by microorganisms for the biodegradation of contaminants. If DO is present in groundwater at concentrations above 0.5 mg/L, aerobic biodegradation is the predominant microbial process. Naturally inhabiting microorganisms in groundwater couple the oxidation of an electron donor (usually organic carbon in contaminants) with the reduction of electron acceptors. In doing so, microorganisms utilize the most thermodynamically favored electron acceptor. In the case of aerobic biodegradation of fuel constituents, microorganisms utilize available oxygen as they biodegrade BTEX and other constituents, and any oxygen entering this zone is rapidly depleted. Thus, an inverse correlation between DO and BTEX concentrations is an indication that aerobic biodegradation is occurring in the subsurface.

Anaerobic:

At DO concentrations below 0.5 mg/L, anaerobic microbes can function and reductive dechlorination can occur. After depletion of DO, anaerobic microorganisms will utilize nitrate as the TEA, followed by ferric iron (Fe^{3+}), then sulfate, and finally carbon dioxide. Measurements of DO concentrations in monitoring wells during each sampling event at a contaminated site provide essential information regarding the availability of geochemical conditions to support reductive dechlorination through microbial degradation processes.

Nitrate is the next most preferred TEA after DO. After DO has been depleted in the contaminant zone, nitrate will be used as TEA for anaerobic biodegradation of organic carbon in contaminants through denitrification. For reductive dechlorination to occur in the subsurface, nitrate concentrations in the contaminated portion of the aquifer must be less than 1.0 mg/L. Because nitrite (NO_2) is an unstable intermediate product of NO_3 reduction, presence of measurable concentrations of NO_2 in groundwater is an indication of NO_3 reduction.

In groundwater with high BTEX concentrations and anaerobic conditions, microorganisms capable of biodegrading BTEX will consume nitrate and thus deplete nitrate concentrations. Thus, an inverse relationship between BTEX concentrations and nitrate can be expected.

Ferric Iron (Fe^{3+}) is used as a TEA during anaerobic biodegradation of organic carbon. During this process, ferric iron is reduced to ferrous iron (Fe^{2+}), which may be soluble in water. Thus, a positive correlation between ferrous iron concentration in groundwater and BTEX compounds is an indication of anaerobic biodegradation.

Sulfate (SO_4^{2-}) can be used as a TEA for anaerobic degradation of organic contaminants. Under strongly reducing conditions and after available oxygen, nitrate and ferric iron have been depleted, sulfate will be used by microorganisms as a TEA. This process results in the generation of sulfide which may precipitate from solution as ferrous sulfide. For example, under sulfate reducing conditions and in the presence of high BTEX concentrations, sulfate demand will be high and sulfate concentrations will be depleted relative to concentrations up gradient of the BTEX contamination zone.

7.2.1.2 Degradation By-Products and other Indicators

Alkalinity in the groundwater is primarily due to the presence of carbon dioxide. Carbon dioxide is produced by the metabolism of microorganisms. Increasing concentrations of carbon dioxide increase the alkalinity in the groundwater. Measuring alkalinity in each round of groundwater sampling and plotting the concentrations as isoconcentration contour maps would provide indication of the progress of biodegradation within the contamination plume.

Geochemical Parameter/ Analyte	Data Use	Trend in Analyte Concentration During Biodegradation	Values Indicative of Degradation	Terminal Electron Accepting Process Causing Trend
Dissolved Oxygen	Concentrations less than about 0.5 mg/L generally indicate an anaerobic pathway	Decreases	<0.5 mg/L	Aerobic Respiration
Nitrate	Electron acceptor for microbial respiration in the absence of oxygen	Decreases	< 1 mg/L	Denitrification
Fe ²⁺	Indication of Fe ³⁺ reduction during microbial degradation of organic compounds in the absence of dissolved oxygen, nitrate, and Mn(IV)	Increases	> 1 mg/L	Fe ³⁺ Reduction
Sulfate(SO ₄ ²⁻)	Electron acceptor for anaerobic microbial respiration	Decreases	< 20 mg/L	Sulfate Reduction
Methane	The presence of methane suggests organic carbon degradation via methanogenesis	Increases	> 0.5 mg/L	Methanogenesis
Alkalinity	General water quality parameter used (1) to measure the buffering capacity of groundwater and (2) as a marker to verify that all site samples are obtained from the same groundwater system.	Increases	> 2 times background	Aerobic Respiration, Denitrification, Reduction, Fe ³⁺ Reduction, Sulfate Reduction
Oxidation reduction potential (ORP)	The ORP of groundwater reflects the relative oxidizing or reducing nature of the groundwater system. ORP is influenced by the nature of the biologically mediated degradation of organic carbon.	Decreases	< -100 mV	Aerobic Respiration, Denitrification, Reduction, Fe ³⁺ Reduction, Sulfate Reduction, Methanogenesis
pH	Aerobic and anaerobic processes are pH-sensitive		Range of 5 to 9	
Chloride	General water quality parameter used as a marker to verify that site samples are obtained from the same groundwater system. Final product of chlorinated solvent reduction	Increases		Reductive Dechlorination or Direct Oxidation of Chlorinated Compound

Source: Adapted from Guidance on Developing a Monitored Natural Attenuation Remedial Proposal for Chlorinated Organics in Ground Water, North Carolina Hazardous Waste Section, October 4, 2000

Oxidation-Reduction Potential (ORP) in groundwater is a measure of the oxidation-reduction (redox) state of the aquifer, and is an indicator of the relative tendency of the groundwater to accept or transfer electrons. The ORP values in groundwater commonly vary from -400 mv to as much as 800 mv, but certain biodegradation processes can occur

only within a specified range of ORP conditions. Lower ORP values in ground water suggest the occurrence of biodegradation.

A comparison of ORP values from the upgradient area of a site with the ORP values in the groundwater contamination plume will indicate the areas where biodegradation is occurring.

pH, Temperature and Conductivity: The pH of groundwater influences the presence and activity of the microbial population in groundwater. Microorganisms capable of degrading aliphatic hydrocarbons and petroleum hydrocarbons generally prefer pH values varying from 6 to 8 standard units. Groundwater temperature directly influences the metabolic activity of microorganisms in groundwater. The conductivity of groundwater is directly proportional to the ions in solution.

Chloride is released into groundwater during the biodegradation of chlorinated hydrocarbons dissolved in groundwater. This results in elevated concentrations of chloride in the contaminated zone relative to the up gradient groundwater. Because of the conservative nature of chloride (chlorides do not enter into any chemical reactions and physical processes control their migration in groundwater), chloride concentrations in groundwater may be used as an indicator of biodegradation where source contaminant concentrations are in the parts per million range.

Degradation Products:

Natural attenuation of chlorinated compounds is accompanied by production of degradation products. Different types of reactions produce different degradation products and the presence of these degradation products indicate the types of degradation reactions. Thus, the presence of specific dechlorination chain of parent and degradation products can be used as direct evidence that natural attenuation is occurring at a site. It is important to document the organic compound species present at the source, in order to evaluate whether the presence of daughter products in downgradient areas is the result of ongoing biodegradation processes or simply the migration of source constituents.

It should be noted that abiotic reductive dechlorination represents a degradation pathway that may be important in some cases, and similar to the reaction of chlorinated ethenes with zero-valent iron, often does not produce the typical intermediate byproducts associated with biological degradation. As noted by Stroo and Ward (2010), EPA (2009) and others (e.g., Ferrey et al.,2004), abiotic transformation of a range of chlorinated compounds has been documented with naturally occurring metal sulfides, including pyrite, troilite, mackinawite, and magnetite. The overall degradation pathway is referred to as “biogeochemical transformation” (AFCEE et al.,2008), because the reactive mineral may be formed as a result of both biological and chemical processes.

7.2.2 Metals & Radionuclides

Metals and radionuclides are not destroyed during attenuation. Metals and radionuclides are attenuated predominantly by immobilization in the aquifer by processes including

adsorption, precipitation and decay (the latter in the case of radionuclides only). With the exception of radioactive decay, all these processes are reversible. Through adsorption and precipitation processes, the metal and radioactive contaminants partition into immobilized forms.

A thorough understanding of the geochemistry of the aquifer system and the behavior of contaminants under these conditions is crucial for evaluating the viability of natural attenuation for sites contaminated with metals and radionuclides. The geochemistry primer presented in Section 2.1 of ITRC (December 2010) publication "A Decision Framework for Applying Monitored Natural Attenuation Processes to Metals and Radionuclides in Groundwater" provides a succinct summary of the role of geochemical processes in the attenuation of metals and radionuclides. As a secondary line of evidence, it is important to demonstrate whether the metal or radionuclide contaminant in groundwater is partitioning from the aqueous phase into the solid phase (precipitation and adsorption) to become immobilized in the aquifer. Further, the rate of attenuation of metal/radionuclide contaminant should be sufficient to account for the stability of the contaminant plume and the capacity of the aquifer should be sufficient to ensure the stability of the contaminant plume for the MNA to be a viable remedial option for a site where groundwater is contaminated with metals or radionuclides.

The solubility, adsorption, and bioavailability of metals and radionuclides depend primarily on metals speciation (ion pairs or more complicated aqueous complexes) because most dissolved metals and radionuclides do not occur as independent ions in groundwater. Uranium is an example which forms stable aqueous complexes by binding strongly with hydroxyl (OH^-), carbonate (CO_3^{2-}), and phosphate (PO_4^{3-}) ions. The aqueous speciation of uranium is a function of the concentrations of these ions in groundwater, concentration of uranium and the pH. For example, at higher pH, carbonate (CO_3^{2-}) is the dominant species and readily complexes with uranium. ORP is another influencing factor in aqueous speciation because oxidation reduction reactions (transfer of electrons from one chemical species to another) change the oxidation state of the metals.

The potential for adsorption (through electrostatic forces) of contaminants onto the aquifer materials is dependent on the aquifer mineralogy and pH. The pH of groundwater influences both aqueous speciation of metals and radionuclides and the surface properties of aquifer minerals.

Ionic strength (correlated with salinity, conductivity and total dissolved solids) of the groundwater also influences adsorption of metals and radionuclides because the ionic strength affects the electrostatic surface properties of aquifer minerals.

Precipitation and dissolution of minerals depend not only on the chemical composition of the groundwater and aquifer mineralogy, but also on the other reactions that are occurring in the aquifer. Use of groundwater analyses (for major cations and anions) and contaminant concentrations to estimate saturation indices is valuable in making predictions as to whether the contaminant is likely to be precipitating.

Modeling should be performed to fully evaluate the geochemical conditions as secondary lines of evidence for MNA as a potential remedial option. These include the mass balance

calculations, geochemical speciation calculations (includes saturation indices), as well as predictive fate and transport models. Aqueous speciation programs estimate concentrations of each contaminant species at a given pH and redox potential through consideration of bulk groundwater geochemistry data (e.g., major cations, anions, other pertinent dissolved constituents, contaminant concentrations). The most widely used of these programs include PHREEQC (Version 2) and MINTEQA2 available at:

http://wwwbrr.cr.usgs.gov/projects/GWC_coupled/phreeqc/index.html
<https://www.epa.gov/exposure-assessment-models/minteqa2>

The saturation indices output provided by these programs is also useful for making interpretations concerning what mineral is saturated or oversaturated (likely to precipitate and hence immobilize) in the aquifer system. Mass balance calculations are useful for the evaluation of MNA based on the masses of metal or radionuclide contaminants, their distribution and masses of reactants that are required to attenuate contaminant mass. Reaction path models combine speciation calculations, mass balance calculations to model the chemical reactions (between groundwater and aquifer minerals) in an aquifer system and include all attenuation mechanisms. For more information visit:

http://crystal.usgs.gov/projects/aqueous_geochemistry/reaction_pathways.html

The reaction path models can be used to identify dominant attenuation mechanisms under different scenarios. It can also be used to determine the sensitivity of attenuation mechanisms to various geochemical parameters (e.g., changing pH). Thus, such models are useful for evaluating the long term stability of immobilized metal contaminants in the aquifer.

EPA's three volume publication (EPA, 2007a; 2007b; 2010) focuses on the natural attenuation processes of nine inorganics (including seven metals) and twelve radioactive substances. These references (described briefly below) should be consulted for a thorough understanding of the natural attenuation mechanisms of metals and radioactive substances and the approach for documenting these mechanisms.

The [first volume](#) contains the technical requirements for assessing the potential applicability of MNA as part of a groundwater remedy for plumes with non-radionuclide and/or radionuclide inorganic contaminants. Volume 1 provides a review of the physical and biogeochemical processes (e.g., sorption, precipitation, transformation, etc.) that govern contaminant transport in groundwater.

The [second volume](#) addresses natural attenuation of arsenic, cadmium, chromium, copper, lead, nickel, nitrate, perchlorate, and selenium and the data requirements to be met during site characterization.

The [third volume](#) covers natural attenuation of radionuclides including americium, cesium, iodine, neptunium, plutonium, radium, radon, technetium, thorium, tritium, strontium, and uranium, and data requirements to be met during site characterization.

7.2.3 Other Reference Used

NJDEP, 2012. New Jersey Department of Environmental Protection. Monitored Natural Attenuation Technical Guidance.

Hyperlink:

http://www.nj.gov/dep/srp/guidance/srra/mna_guidance_v_1_0.pdf

References

AFCEE, Naval Facilities Engineering Services Center (NFESC), Environmental Security Technology Certification Program (ESTCP). 2008. *Workshop on In Situ Biogeochemical Transformation of Chlorinated Solvents*. Prepared by CDM. Bellevue, WA.

Artiola, J.F. and Uhlman, K. 2009. Arizona Well Owner's Guide to Water Supply.

Abbaszadegan, M., M. LeChevallier, and C.P. Gerba. 2003. Occurrence of viruses in U.S. Groundwaters. *J. Amer. Water Works Assoc.*, 95(9):107-120.

ADEQ, 2005. Arizona Department of Environmental Quality, Arizona's Integrated 305(b) Assessment and 303(d) Listing Data, Phoenix.

ASTM 2002. Standard Practice for Evaluating the Performance of Diffusive Samplers. ASTM D6246-02.

ASTM 2003. Standard Guide for Placement and Use of Diffusion Controlled Passive Monitors for Gaseous Pollutants in Indoor Air. ASTM D6306-98 (reapproved 2003)

ATSDR. 2005. Agency of Toxic Substances and Disease Research. Public Health Assessment Manual. pp. 5 – 20 and Chapters 5 and 6.

ADWR 2008a. Arizona Department of Water Resources. Well Statistics.
http://www.azwater.gov/dwr/Content/Find_by_Program/Wells/Construction_Estimate_Chart_colorful2007.pdf

ADWR 2008b. Arizona Department of Water Resources. Arizona Water Atlas, Volume 2.

Bartholomay, R.C. J.M. Carter, S.L. Qi, JH. Squillace, and G.L. Rowe. 2007. Summary of Selected U.S. Geological Survey Data on Domestic Well Water Quality for the CDC NEPHTP. USGS Report 2007-5213.

CDC. 1998. Centers for Disease Control and Prevention. <http://www.cdc.gov/index.htm> Fact Sheet—06-68. 2006. Shock Chlorination: Background and Principles.

Cherry, J.A. and S. Feenstra, 1991. Identification of DNAPL sites: An eleven point approach, draft document in Dense Immiscible Phase Liquid Contaminants in Porous and Fractured Media, short course notes, Waterloo Centre for Ground Water Research, Kitchener, Ontario.

Cohen, R.M., A.P. Bryda, S.T. Shaw and C.P. Spalding, 1992. Evaluation of visual methods to detect NAPL in soil and water, *Ground Water Monitoring Review*, 12(4):132-141

October 2014 ADEQ Waste Programs Division
Site Investigation Guidance Manual

Cohen, R. and J. Mercer. 1993. DNAPL Site Evaluation. C.K. Smoley Publishing. Boca Raton, Fla. 369 pp.

Crumbling, D., C. Groenis, B. Lesnik, K. Lynch, J. Shockley, J. Van, R. Howe, L. Keith and J. McKenna. October 2001. Managing Uncertainty in Environmental Decisions. *Environmental Science and Technology*. pp. 405-409

Crumbling, D., Hayworth, J.S., Johnson, R.L., and Moore, M. 2004. The Triad Approach: A Catalyst for Maturing Remediation Practice.

EPA. 1989. Human Health Evaluation Manual, Part A, Risk Assessment Guidance for Superfund, Volume I, Interim Final. Office of Emergency and Remedial Response, Washington, DC. EPA/540/1-89/002.

EPA. 1992. Corrective Action Glossary. Office of Solid Waste and Emergency Response. Office of Waste Programs Enforcement. EPA 9902.3-1a. Washington, D.C.

EPA. 1994. [OSWER Directive: Revised Interim Soil Lead \(Pb\) Guidance for CERCLA Sites and RCRA Corrective Action Facilities](#). EPA/540/F-94/043 PB94-963282.

EPA, 1995. [How to Evaluate Alternative Cleanup Technologies for Underground Storage Tank Sites](#). EPA 510-B-95-007.

EPA.1996. Soil Screening Guidance. July. Pub 9355.4-23. Available online: <http://www.epa.gov/superfund/resources/soil/ssg496.pdf>.

EPA, 2002. [Groundwater Sampling Guidelines for Superfund and RCRA Project Managers](#). EPA542-S-02-001. May 2002.

EPA, 2003. [Superfund Lead-Contaminated Residential Sites Handbook](#). OSWER 9285.7-50. August 2003.

EPA. 2004. [US Environmental Protection Agency. Performance Monitoring of Monitored Natural Attenuation Remedies for VOCs in Ground Water](#).

EPA. 2006. US Environmental Protection Agency. Guidance on Systematic Planning Using the Data Quality Objectives Planning Process.

EPA. 2007a. Monitored Natural Attenuation of Inorganic Contaminants in Groundwater, Volume 1, Technical Basis for Assessment. EPA/600/R-07/139. October 2007.

EPA. 2007b. Monitored Natural Attenuation of Inorganic Contaminants in Ground Water Volume 2, Assessment for Non-Radionuclides Including Arsenic, Cadmium, Chromium, Copper, Lead, Nickel, Nitrate, Perchlorate, and Selenium. EPA/600/R-07/140. October 2007.

EPA, 2008. Private Drinking Water Wells. <http://water.epa.gov/drink/info/well/index.cfm>

EPA. 2009. Identification and Characterization Methods for Reactive Minerals Responsible for Natural Attenuation of Chlorinated Organic Compounds in Ground Water. Office of Research and Development, National Risk Management Research Laboratory. Ada, Oklahoma. EPA 600/R-09/115.

EPA. 2010. Monitored Natural Attenuation of Inorganic Contaminants in Ground Water Volume 3: Assessment for Radionuclides Including Tritium, Radon, Strontium, Technetium, Uranium, Iodine, Radium, Thorium, Cesium, and Plutonium-Americium (EPA/600/R-10/093) September 2010

Ferrey, M.L., R.T. Wilken, R.G. Ford, and J.T. Wilson. (2004). Nonbiological Removal of cis-Dichloroethylene and 1,1-Dichloroethylene in Aquifer Sediment Containing Magnetite. *Environmental Science & Technology*, Vol.38(60):1746-1752.

Fetter, C.W. 1988. 2nd Edition. *Applied Hydrogeology*. Merrill Publishing Company, Columbus, Ohio. 592 pp.

Fetter, C.W. 1999. *Contaminant Hydrogeology*. Prentice Hall, Upper Saddle River, New Jersey, 598p.

Fetter, C.W. 2001. 4th Edition. *Applied Hydrogeology*. Merrill Publishing Company, Columbus, Ohio. 592 pp.

Foust Jr., R.D., P. Hohapatra, A.M. Compton – O'Brien, and J. Reifel. 2003. Groundwater arsenic in the Verde Valley in central Arizona, USA. *Applied Geochemistry*. 19 (2004) 251-255.

Gilbert, R.O. 1987. *Statistical Methods for Environmental Pollution Monitoring*. Van Nostrand Reinhold. New York, New York.

Geoprobe Systems 2006. *Direct Push Installation of Devices for Active Soil Gas Sampling & Monitoring*. Technical Bulletin No. MK3098

Harshbarger, J.W., D.D. Lewis, H.E. Skibitzke, W.L. Heckler, L.R. Kister, and H.L. Baldwin. 1966. *Arizona Water*. U.S. Geological Survey Water Supply Paper 1648. U.S. Government Printing Office, Washington D.C. 84 pages.

Hawai'i Department of Health. 2009. *Technical Guidance Manual for the Implementation of the Hawai'i State Contingency Plan*. Chapter 6 – Groundwater and Surface Water Sampling Guidance.

Hem, John D. 1985. *Study and Interpretation of the Chemical Characteristics of Natural Water*, Third Edition. U.S. Geological Survey Water-Supply Paper 2254. 258 pp.

October 2014 ADEQ Waste Programs Division
Site Investigation Guidance Manual

Huling, S.G. and J.W. Weaver 1991. Dense Nonaqueous Phase Liquids. U.S. EPA, Office of Research and Development, Office of Solid Waste and Emergency Response. EPA/540/4-91-002.

IITRC. 2003. Interstate Technical Regulatory Council. Technical and Regulatory Guidance for the Triad Approach: A New Paradigm for Environmental Project Management

IITRC. 2007. Interstate Technical Regulatory Council. Technical and Regulatory Guidance – Vapor Intrusion Pathway: A Practical Guideline.

IITRC. 2012. Interstate Technical Regulatory Council. Technical and Regulatory Guidance – Incremental Sampling Methodology. Appendix D.

Johnson Division. 1972. Groundwater and Wells. Second printing. Edward E. Johnson, Inc. Universal Oil Products Co., Saint Paul, Minnesota.

Kamilli, R.J., and S.M. Richard, editors. 1998. Geologic Highway Map of Arizona. Arizona Geological Survey, Tucson.

Karpiscak, M.M., C.P. Gerba, R. Marrero-Ortiz, and K.R. Raley. 2006. Evaluation of water quality in individual and small water systems in Arizona.

Kenny, Ray. 2003. The legacy of the Grand View Mine, Grand Canyon, National Park, Arizona. Park Science, Volume 22, Number 1, Fall 2003. pp. 46-58.

Luo, H., P. Dahlen, P. Johnson, T. Creamer, T. Peagin, P. Lundegard, B. Hartman, L. Abreau, and T. McAlary. 2006. “Spatial and Temporal Variability in Hydrocarbon and Oxygen Concentrations Beneath a Building Above a Shallow NAPL Source.” Presented at Remediation of Chlorinated and Recalcitrant Compounds, Monterey, Calif.

Ohio EPA. 2007. Technical Guidance Manual for Ground Water Investigations. Chapter 14 – Ground Water Flow and Fate and Transport Modeling

Marrero-Ortiz, Roberto. 2007. Assessment of the microbial and chemical water quality of individual and small system groundwater supplies in Arizona. Ph.D. Dissertation.

Myers, J and K. Thorbjornsen. March 18, 2013. *Geochemical Evaluations of Metals in Environmental Media: How to Distinguish Naturally Elevated Concentrations from Site-Related Contamination*. The 23rd Annual International Conference on Soil, Water, Energy, and Air. San Diego, CA.

Newell, C.J. and R.R. Ross, 1992. Estimating potential for occurrence of DNAPL at Superfund sites, USEPA Quick Reference Fact Sheet, Robert S. Kerr Environmental Research Laboratory, Ada, Oklahoma.

October 2014 ADEQ Waste Programs Division
Site Investigation Guidance Manual

NJDEP, 2005. New Jersey Department of Environmental Protection. Field Sampling Procedures Manual. Chapter 9 – Soil Gas Surveys.

NJDEP, 2011. New Jersey Department of Environmental Protection. Technical Guidance for Preparation and Submission of a Conceptual Site Model.

NJDEP, 2012. New Jersey Department of Environmental Protection. Monitored Natural Attenuation Technical Guidance.

Nielsen, D.M., 2006. Practical Handbook of Environmental Site Characterization and Ground-water Monitoring. 2nd edition.

Nielsen, D.M. and G.L. Nielsen. 2007. The Essential Handbook of Ground-Water Sampling. CRC Press, 309 pgs.

Payal, Sakar. 2008. Occurrence and Inactivation of emerging pathogens in the environment. Ph.D. Dissertation. University of Arizona, Tucson, Arizona.

Puls, R.W. and Barcelona, M.J. (Puls and Barcelona), 1989. Superfund Ground Water Issue. EPA Office of Solid Waste and Emergency Response. EPA/540/4-89/001. March 1989.

Robbat, A. Jr., Smarason, S., and Gankin, Y., 1998. "Dynamic Work Plans and Field Analytics: The Keys to Cost-Effective Hazardous Waste Site Investigations," *Field Anal. Chem. Technol.* Vol. 2, 253–65.

Robbat, A. Jr., Smarason, S., and Gankin, Y., 1999. "Fast Gas Chromatography/Mass Spectrometry Analysis in Support of Risk-Based Decisions," *Field Anal. Chem. Technol.* Vol. 3, 55–66.

Robertson, F. N. 1975. Hexavalent chromium in the groundwater in Paradise Valley, Maricopa County, Arizona: *Groundwater* v. 13, p 516-527

Schwille, F. 1988. Dense Chlorinated Solvents in Porous and Fractured Media; Model Experiments (English Translation). Lewis Publishers. Chelsea Michigan.

Snedecor, G.W. and Cochran, W.G. 1989. Statistical Methods. Iowa State University Press. Ames, Iowa.

Stroo H. F. and C. H. Ward (Eds). 2010. In Situ Remediation of Chlorinated Solvents. SERDP and ESTCP Remediation Technology Monograph Series. Springer. New York.

The Groundwater Foundation 2013. <http://www.groundwater.org/get-informed/groundwater/contamination.html>

October 2014 ADEQ Waste Programs Division
Site Investigation Guidance Manual

Uhlman, K., Boellstorff, D.E., McFarland, M.L., Clayton, B. and Smith, J.W. 2012. Well Owner's Guide To Water Supply. Texas A & M System
<http://twon.tamu.edu/media/358238/lowres.pdf>

USACE. 2012. United States Army Corps of Engineers. Conceptual Site Models, EM200-1-12

United States Geological Survey (USGS), 2002. Book 9, Handbooks for Water-Resources Investigations - National Field Manual for the Collection of Water-Quality Data – Chapter A2: Selection of Equipment for Water Sampling. Version 2. March 2002. http://water.usgs.gov/owq/FieldManual/Chapter2/Chapter2_V3-1.pdf

WRRC. 2002. Arizona Water Poster. Water Resources Research Center. University of Arizona.

Yavapai County, Arizona. 2008. <http://www.co.yavapai.az.us/>

APPENDIX A – Conceptual Site Model Form/Checklists

PRELIMINARY CONCEPTUAL SITE MODEL FORM	
<p>This form identifies the types of information which should be collected during the preliminary investigative process for the development of the preliminary conceptual site model. All items on this form may not apply to each site, and depending upon the complexity of the site, there may be additional information needed. Be sure to delete older versions as updates are created.</p>	
Prepared By:	
Site Name:	
Site Address:	
City/State/Zip:	Site Code:
Site Characteristics	
Zoning/Site Setting	Industrial
	Commercial
	Residential
	Undeveloped
	Rural
	Agricultural
	Other
Active Management Area (AMA)/Water Provider	
Nearby Contaminated Sites (Program/COCs)	
Facility Structures	
Physical Boundaries	

October 2014 ADEQ Waste Programs Division
Site Investigation Guidance Manual

Process/Manufacturing Areas
Waste Storage/Disposal
Underground/Overhead Utilities
Drywells
Sewer System
Site History - Owners/Operators/Features/Aerial Photos/Permits
Topographic, Pavement, Vegetative Features/Natural Barriers
Surface Water/Drainage
Regional Hydrogeology
Site Hydrogeology

Contaminant Information	
Release Point Location(s):	
Release Material:	
Contaminants of Concern (COCs):	
Date of Release:	
Release Volume:	
Date of Discovery:	
Impacted Media:	Soil/Soil Gas
	Groundwater
	Surface Water
	Sediment
	Air
Initial Corrective Actions:	

October 2014 ADEQ Waste Programs Division
 Site Investigation Guidance Manual

Potential Receptors	Wells & Uses
	Buildings
	Sensitive Populations
	Biological Receptors
	Other
Potential Decision Units/Characterization Goals	Source Area (s)
	Exposure Area(s)

CONTINUATION OF CONCEPTUAL SITE MODEL FORM	
<p>This is an optional more detailed form that identifies the types of information which should be collected during the investigative process for the development of the conceptual site model. All items on this form may not apply to each site, and depending upon the complexity of the site, there may be additional information required to complete the development of the conceptual site model. This form is meant for the development after the preliminary CSM and initial field activities have been completed.</p>	
Prepared By:	
Site Name:	
Site Address:	
City/State/Zip:	Site Code:
Be sure to delete older versions as updates are created.	
Site Characteristics	
Zoning/Site Setting	Industrial
	Commercial
	Residential
	Undeveloped
	Rural
	Agricultural
	Other
Active Management Area (AMA)/Water Provider	
Nearby Contaminated Sites (Program/COCs)	
Facility Structures	
Physical Boundaries	

October 2014 ADEQ Waste Programs Division
Site Investigation Guidance Manual

Process/Manufacturing Areas
Waste Storage/Disposal
Underground/Overhead Utilities
Drywells
Sewer System
Site History - Owners/Operators/Features/Aerial Photos/Permits
Topographic, Pavement, Vegetative Features/Natural Barriers
Surface Water/Drainage
Regional Hydrogeology
Site Hydrogeology

Contaminant Information	
Release Point Location(s):	
Release Material:	
Contaminants of Concern (COCs):	
Date of Release:	
Release Volume:	
Date of Discovery:	
Impacted Media:	Soil/Soil Gas
	Groundwater
	Surface Water
	Sediment
	Air
Initial Corrective Actions:	

Regional Hydrogeology	
Site Hydrogeology	
Current/Future Receptors	Wells & Uses
	Buildings
	Sensitive Populations
	Biological Receptors
	Other

October 2014 ADEQ Waste Programs Division
Site Investigation Guidance Manual

Potential Decision Units/Characterization Goals	Source Area (s)
	Exposure Area(s)
Site Lithology/Hydrology	
Soil Borings and Wells (Locate On Map)	

October 2014 ADEQ Waste Programs Division
 Site Investigation Guidance Manual

Physical Properties of Subsurface Materials	Porosity
	Moisture Content
	Total Organic Carbon Content
	Dry Bulk Density
	Permeability
Hydrology	Depth to Groundwater
	Flow Direction
	Gradient
	Seasonal Variations
	Depth to Groundwater
	Flow Direction
	Gradient
	Long-Term Trends
	Depth to Groundwater
	Flow Direction

October 2014 ADEQ Waste Programs Division
 Site Investigation Guidance Manual

Hydrology (continued)	Gradient
	Aquifer Testing Results
	Transmissivity
	Hydraulic Conductivity
	Storativity/Capacity
	Effective Porosity
Meteorological Data	
Geophysical Data	
Plume Definition	Unsaturated Zone
	Saturated Zone

COC Properties	
COC	Solubility
	Density
	Viscosity
	Henry's Coefficient
	Organic Carbon to Water Partitioning Coefficient
	Vapor Pressure
COC	Solubility
	Density
	Viscosity
	Henry's Coefficient
	Organic Carbon to Water Partitioning Coefficient
	Vapor Pressure
COC	Solubility
	Density
	Viscosity
	Henry's Coefficient
	Organic Carbon to Water Partitioning Coefficient
	Vapor Pressure
COC	Solubility
	Density
	Viscosity
	Henry's Coefficient
	Organic Carbon to Water Partitioning Coefficient
	Vapor Pressure
NAPL Present	Unsaturated Zone
	Saturated Zone
Estimate of Contaminant Mass	Unsaturated Zone
	Saturated Zone

Modeling Results
Unusual Site Conditions
Beneficial Ecological & Cultural Resource Determination (e.g., natural resources, wetlands, cultural resources, etc.)
Current and Future Resource Locations (e.g., hiking trails, grazing lands, recreational swimming, etc.)
Current and Future Demographics (e.g., hospitals, schools, day care, etc.)

